

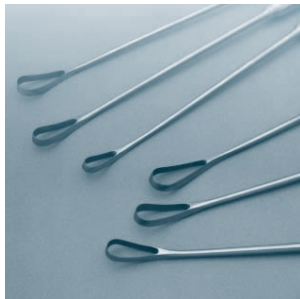

NÁSTROJE PRO GYNEKOLOGII
INSTRUMENTS FOR GYNAECOLOGY

G Y N E K O L O G I E – G Y N A E C O L O G Y

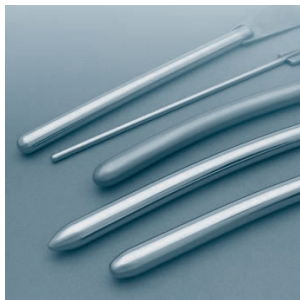

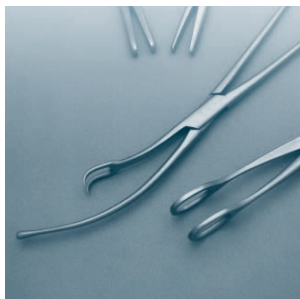
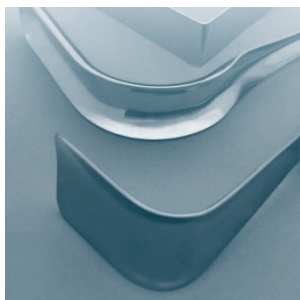
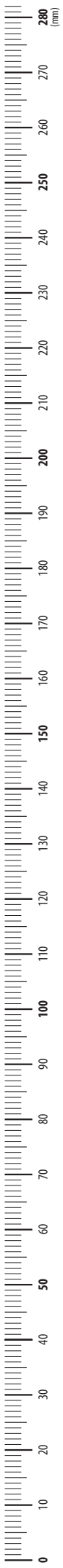

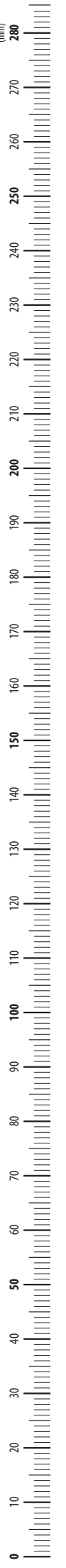



MEDIN, a.s.

Vlachovická 619
Nové Město na Moravě
CZ 592 31
Czech Republic
IČO 43378030
DIČ CZ43378030

CENTRÁLA

tel.: 566 684 111

PRODEJ ČESKÁ REPUBLIKA

tel.: 566 684 327-8
fax: 566 684 384
e-mail: prodej@medin.cz

PRODEJNA PRAHA

Jana Želivského 6
Praha 3
CZ 130 00
tel./fax: 222 592 334
mobil: 606 686 530

PRODEJ SLOVENSKÁ REPUBLIKA

tel.: +420 566 684 332
fax: +420 566 684 385
e-mail: export@medin.cz

EXPORT

phone: +420 566 684 336
fax: +420 566 684 385
e-mail: export@medin.cz

www.medin.cz



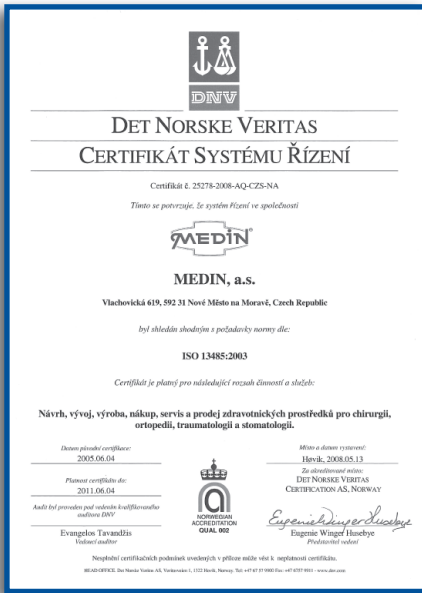

Certifikát EN ISO 13485
Certificate EN ISO 13485

CE 0434

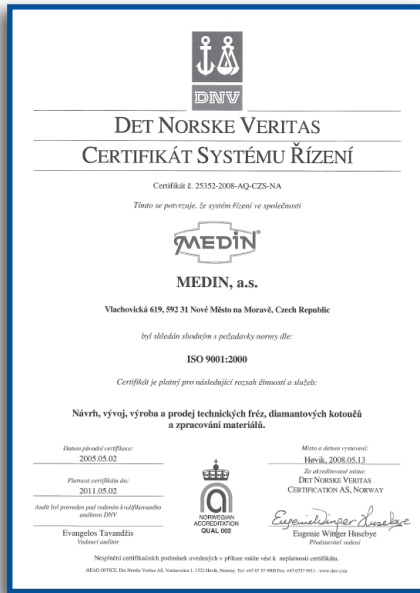

Certifikát ISO 9001
Certificate ISO 9001



Certifikát ISO 14001
Certificate ISO 14001

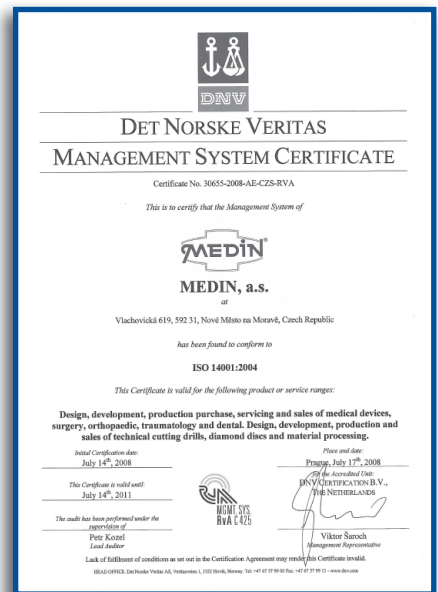
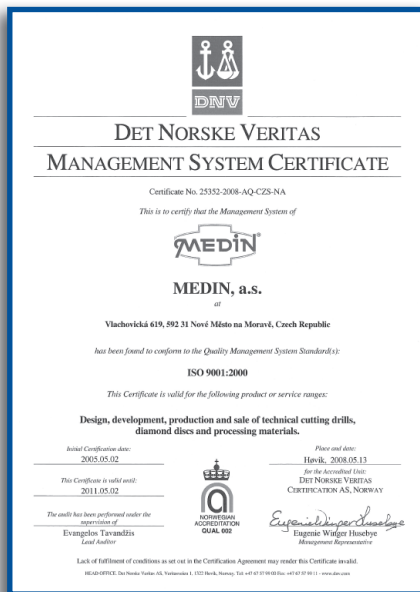
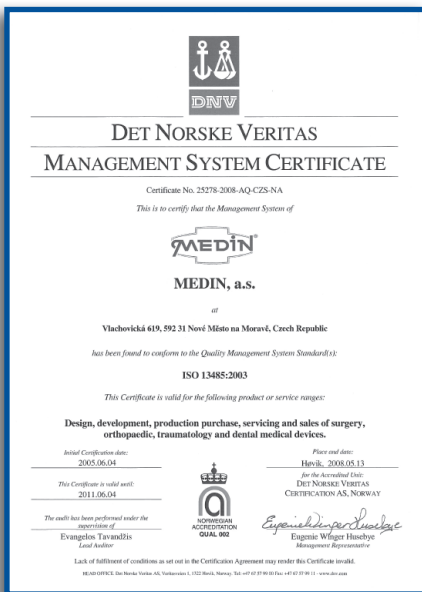

Akciová společnost MEDIN se sídlem v Nové Městě na Moravě zahájila činnost 4. 5. 1992 jako právní nástupce bývalého státního podniku Chirana Nové Město na Moravě.

MEDIN, a.s., je největší český výrobce nástrojů pro humánní lékařství ve všech hlavních oborech lékařských specializací včetně kostní chirurgie a implantátů pro traumatologii a ortopedii. Zároveň je největším českým výrobcem dentálních nástrojů jak ordinálních, tak rotačních.

Dlouholetá tradice výroby lékařských nástrojů, začínající již v roce 1949, vytvořila know-how umožňující dodávat výrobky vysoké kvality s ohledem na dosažení vysoké míry bezpečnosti odpovídající vysoké úrovni ochrany zdraví. Úroveň, kvalita a bezpečnost všech nástrojů je pečlivě posuzována. Akcent na kvalitu a bezpečnost nástrojů je tradičně zakotven ve firemní politice jakosti a strategii firmy. V kvalitě používá firma účinných postupů dle mezinárodních norem *ISO 9001 Systémy managementu kvality* a *ISO 13485 Systémy jakosti – Zdravotnické prostředky*, jejichž certifikáty jsou pravidelně obnovovány. Důležitou oblastí je splnění legislativních podmínek při uvádění výrobků na trh, zejména evropské direktivy Medical Device 93/42/EHS.

MEDIN, a.s., uplatňuje aktivní postoj k ochraně životního prostředí a praktickou činností směřuje k minimalizaci dopadů vlivů firemních činností na životní prostředí. Komplex výrobních, pomocných a administrativních prostor společnosti splňuje použitými technologiemi a energetickými zdroji přísná ekologická hlediska. Prostřednictvím profesně i odborně způsobilých pracovníků trvale udržuje šetrný vztah k životnímu prostředí. Environmentální management firmy je udržován v souladu s mezinárodní normou *ISO 14001 Systémy environmentálního managementu*.

MEDIN, the joint-stock company, having its headquarters in Nové Město na Moravě commenced its activity on May 4, 1992 as a legal successor of the former state-owned enterprise Chirana Nové Město na Moravě.

MEDIN, the joint-stock company, is the greatest Czech producer of instruments for human medicine in all main fields of medical specialisations, including the bone surgery and implants for traumatology and orthopaedics. It is also the biggest producer of surgery and rotary dental instruments.

A long standing tradition of surgical instruments production, founded as early as 1949, has established a know-how that enables to provide products of high quality and safety corresponding to high level of health protection. The standards, quality and safety of all instruments are carefully evaluated. The quality and safety of the instruments are traditionally anchored in the company's quality policy and company's strategy. We use the effective procedures according to the International Standard *ISO 9001 – Systems of quality management* and *ISO 13485 Quality Systems – Medical Instruments* whose certificates are regularly renewed. It is also very important to follow the legislative conditions when launching the products on the market, mainly the European Directive Medical Devices 93/42/EEC.

MEDIN, the joint-stock company, cares about the environment actively and minimises the impacts of the company's activity on the environment. The complex of production, auxiliary and administration buildings of the company meets the strict environmental aspects with the applied technologies and energy sources.

We permanently keep a considerate relation with our environment through our professionals and specialists. The Environmental management of the company is in conformity with *ISO 14001 – Systems of environmental management*.



397 111 Diagnostika	Diagnostic	9–10
397 112 Nástroje řezné	Cutting Instruments	11–11
397 113 Nůžky	Scissors	12–22
397 114 Pinzety	Forceps	23–24
397 115 Svorky	Clamps, Forceps	25–61
397 116 Kleště štípací	Bone Rongeurs	62–70
397 117 Kleště úchopné	Grasping Forceps	71–84
397 118 Háky	Hooks, Retractors	85–92
397 119 Rozvěrače	Retractors	93–98
397 121 Lopatky	Spatulas	99–99
397 122 Zrcadla	Specula	100–113
397 124 Škrabky	Raspatories	114–114
397 125 Lžičky	Bone Curettes	115–117
397 126 Kyrety	Curettes	118–126
397 132 Jehly, Jehelce	Needle, Needle Holders	127–133
397 133 Pátradla	Probes	134–135
397 135 Dilatátory	Dilators	136–136
397 136 Nástroje speciální	Special Instruments	137–141
397 136 Extraktory	Extractors	142–142
Číselný rejstřík	Numerical Index	143–160
Jmenný rejstřík	Alphabetical Index	161–166



1/2

SCHULTZE
111 91 0092

komplet – complete

		počet ks – number of pcs
111 91 0161	MANOMETR K SALPINGOGRAFU	1
111 91 0162	STRÍKAČKA K SALPINGOGRAFU	1
111 91 0163	KUŽEL K SALPINGOGRAFU MALÝ	1
111 91 0164	KUŽEL K SALPINGOGRAFU STŘEDNÍ	1
111 91 0165	KUŽEL K SALPINGOGRAFU VELKÝ	1
111 91 0166	KATETR K SALPINGOGRAFU	1

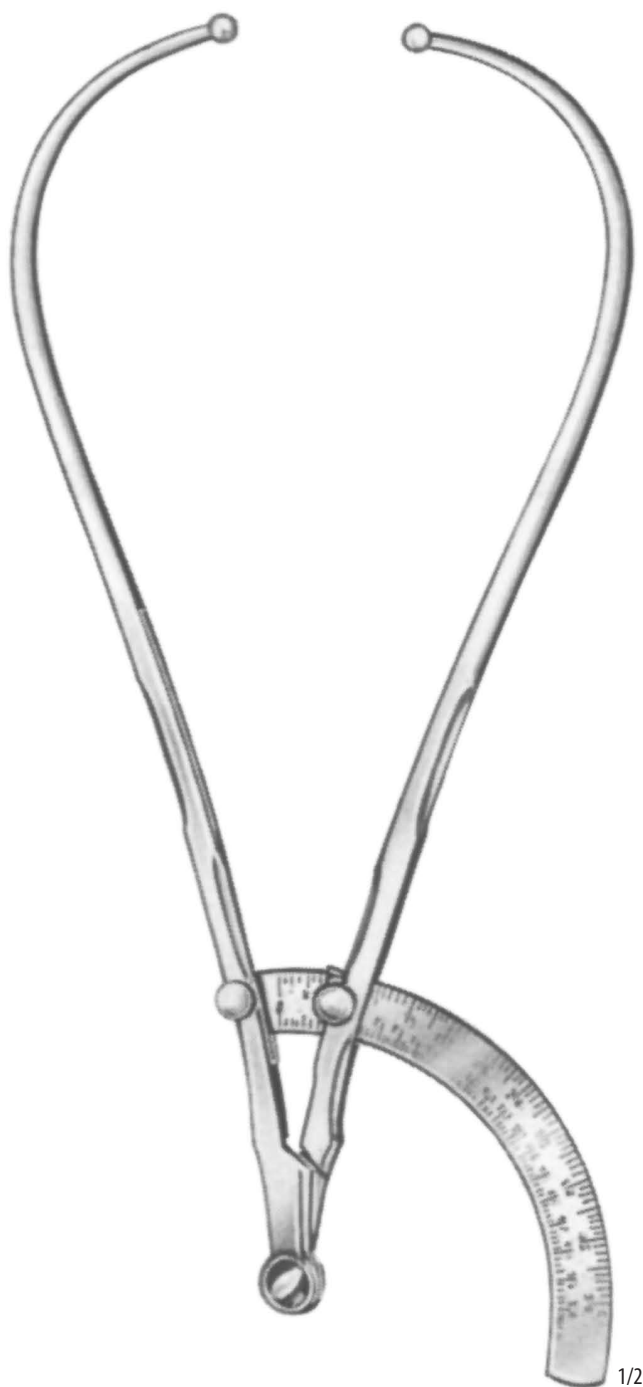

MARTIN
PELVIMETR
PELVIMETER
111 91 0093
34,0 cm



MĚŘÍTKO
MEASURING INSTRUMENT
111 91 0110
18,0 cm

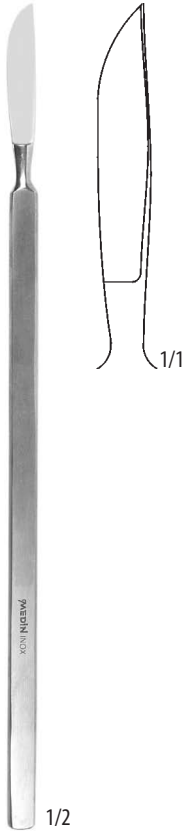

112 27 0040
21,8 cm

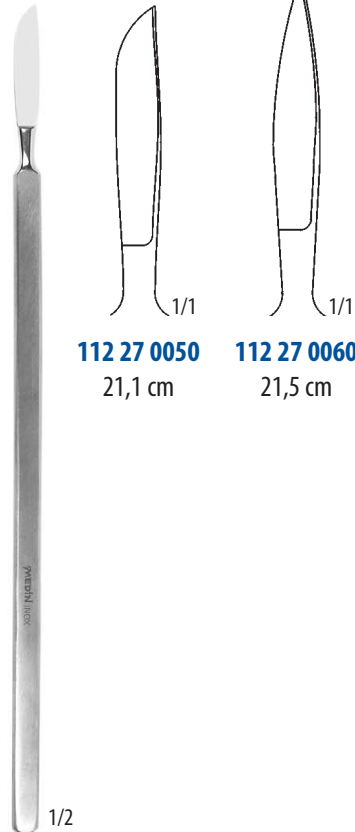

112 27 0050
21,1 cm

112 27 0050
21,1 cm

112 27 0060
21,5 cm

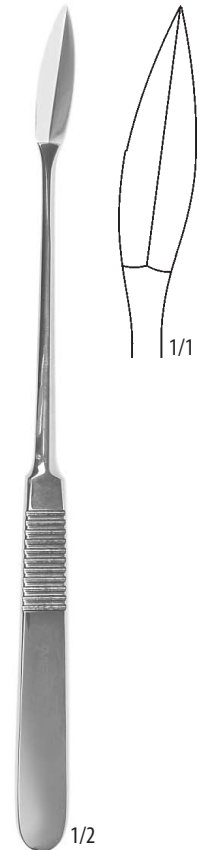

SEGOND
112 27 0250
22,3 cm



DEAVER
113 91 0077
14,0 cm

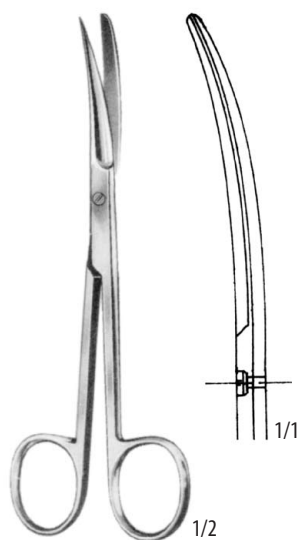

DEAVER
113 91 0078
14,0 cm

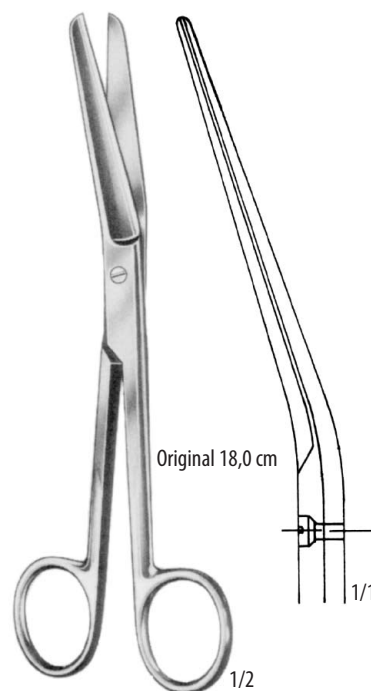

FERGUSSON
113 91 0075
16,5 cm
113 91 0076
18,0 cm

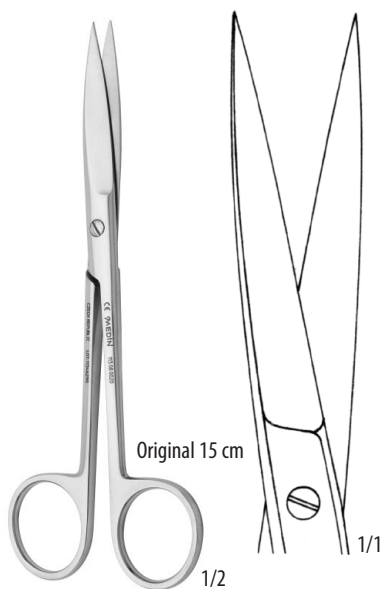

STANDARD

rovné – straight	zahnuté – curved
113 91 0042 – 11,5 cm	– 113 91 0051
113 08 0010 – 13,0 cm	– 113 08 0310
113 08 0020 – 15,0 cm	– 113 08 0320
113 91 0046 – 16,5 cm	– 113 91 0055
113 08 0040 – 18,5 cm	– 113 08 0340
113 91 0049 – 20,0 cm	– 113 91 0058
113 08 0060 – 22,0 cm	– 113 08 0360
113 08 0070 – 30,0 cm	– 113 08 0370

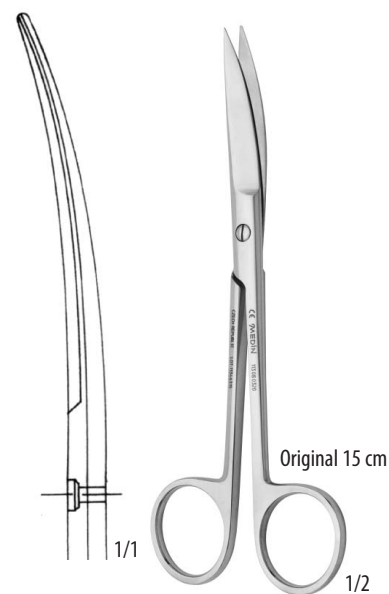

STANDARD

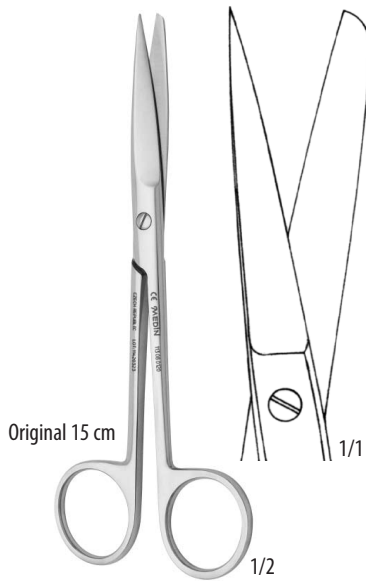

STANDARD

rovné – straight	zahnuté – curved
113 91 0020 – 11,5 cm	– 113 91 0031
113 08 0110 – 13,0 cm	– 113 08 0410
113 08 0120 – 15,0 cm	– 113 08 0420
113 91 0026 – 16,5 cm	– 113 91 0037
113 08 0140 – 18,5 cm	– 113 08 0440
113 91 0029 – 20,0 cm	– 113 91 0040
113 08 0160 – 22,0 cm	– 113 08 0460
113 08 0170 – 30,0 cm	– 113 08 0470

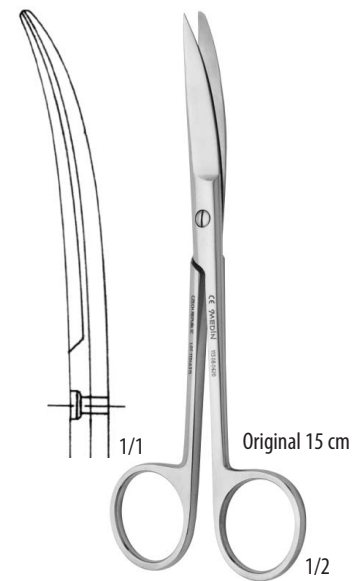

STANDARD

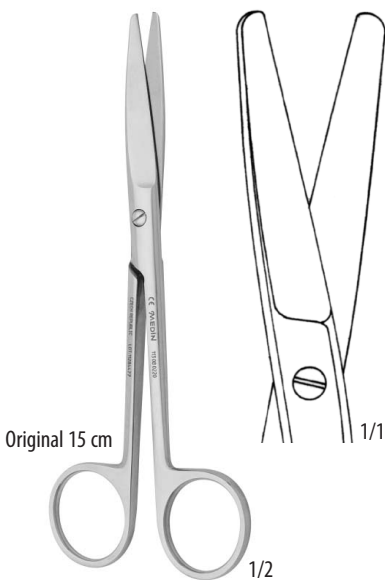

STANDARD

rovné – straight	zahnuté – curved
113 91 0002 – 11,5 cm	– 113 91 0011
113 08 0210 – 13,0 cm	– 113 08 0510
113 08 0220 – 15,0 cm	– 113 08 0520
113 91 0006 – 16,5 cm	– 113 91 0015
113 08 0240 – 18,5 cm	– 113 08 0540
113 91 0009 – 20,0 cm	– 113 91 0018
113 08 0260 – 22,0 cm	– 113 08 0560
113 08 0270 – 30,0 cm	– 113 08 0570

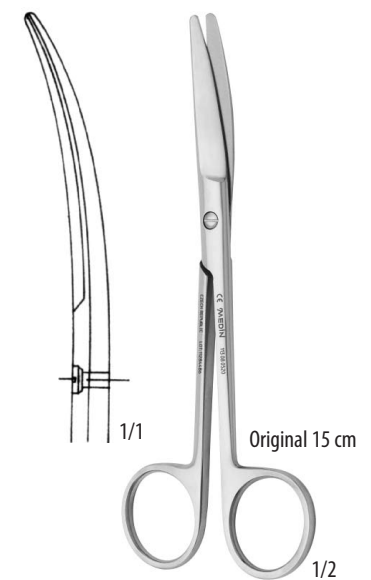

STANDARD



KELLY
113 91 0110
rovné – straight
16,0 cm

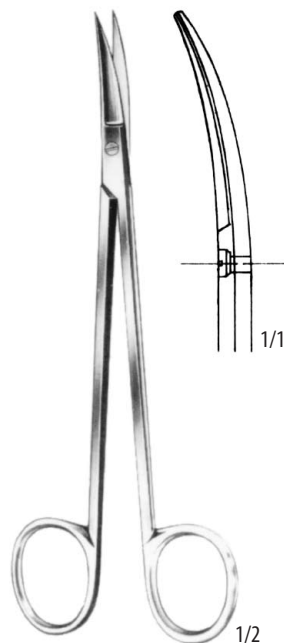

KELLY
113 91 0112
zahnuté – curved
16,0 cm



SIMS
113 91 0117 – 20,0 cm
113 91 0118 – 23,0 cm

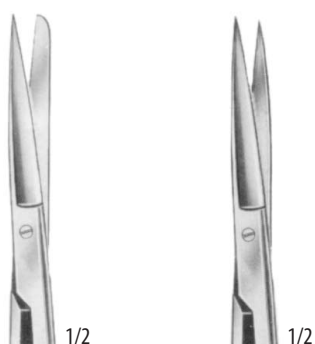

SIMS
113 91 0121 – 20,0 cm – **113 91 0125**
113 91 0122 – 23,0 cm – **113 91 0126**

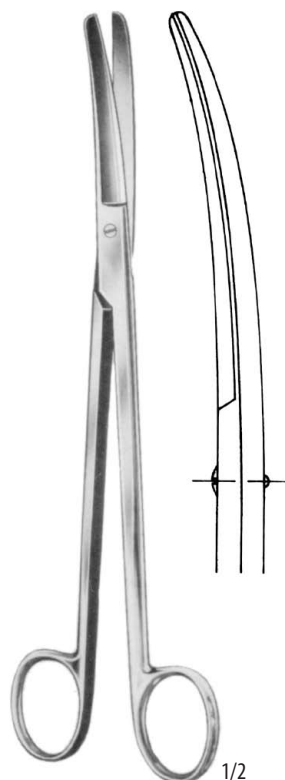

SIMS
113 91 0119 – 20,0 cm
113 91 0120 – 23,0 cm

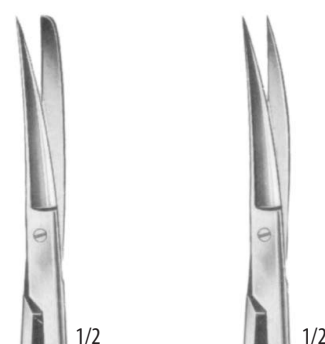

SIMS
113 91 0123 – 20,0 cm – **113 91 0127**
113 91 0124 – 23,0 cm – **113 91 0128**



BRAUN-STADLER
113 91 0317
14,0 cm



BRAUN-STADLER
113 91 0318
22,0 cm

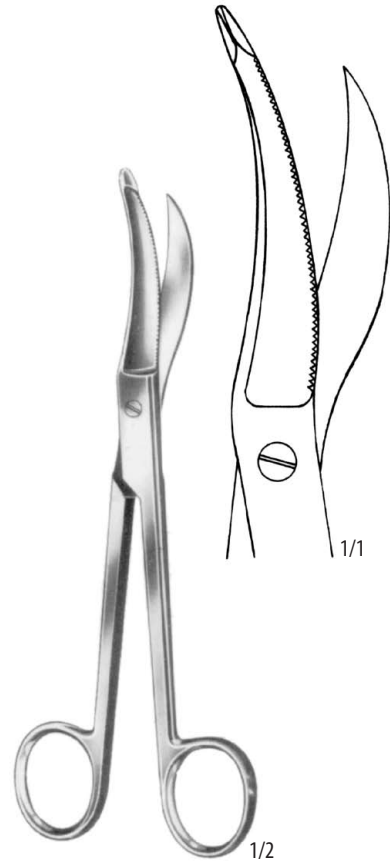

WALDMANN
113 91 0319
18,0 cm



DUBOIS
113 91 0129
27,0 cm

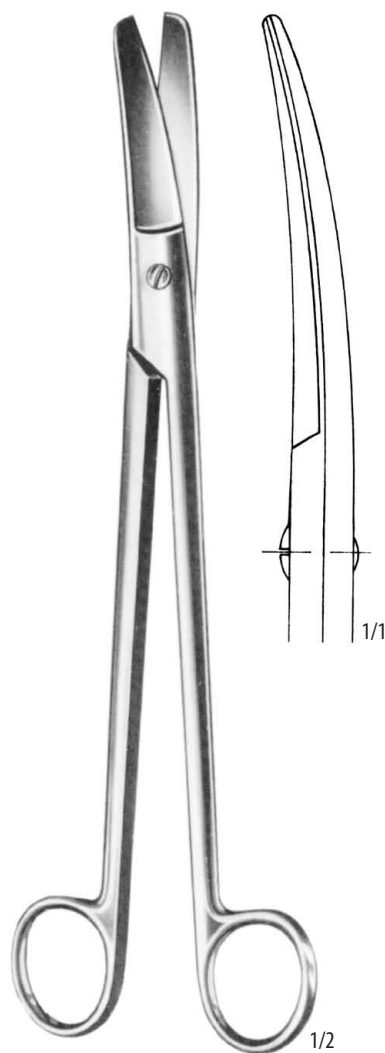

DUBOIS
113 91 0130
27,0 cm

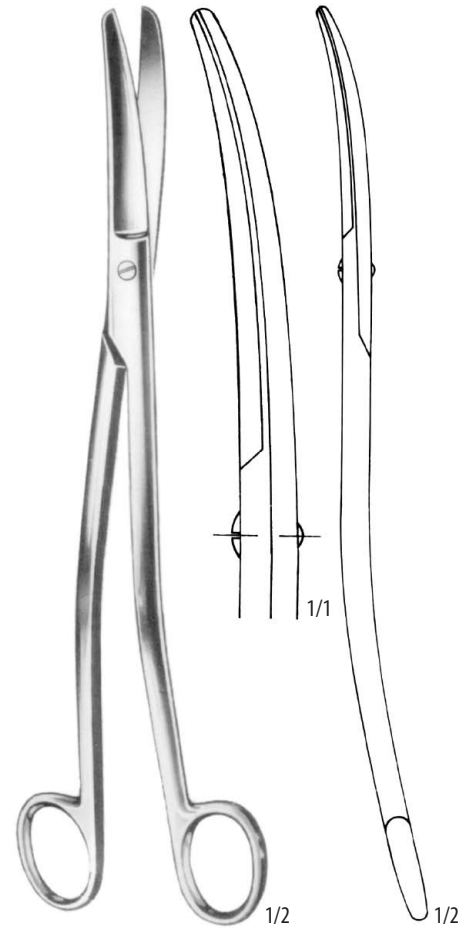

SIEBOLT
113 27 0010
24,0 cm

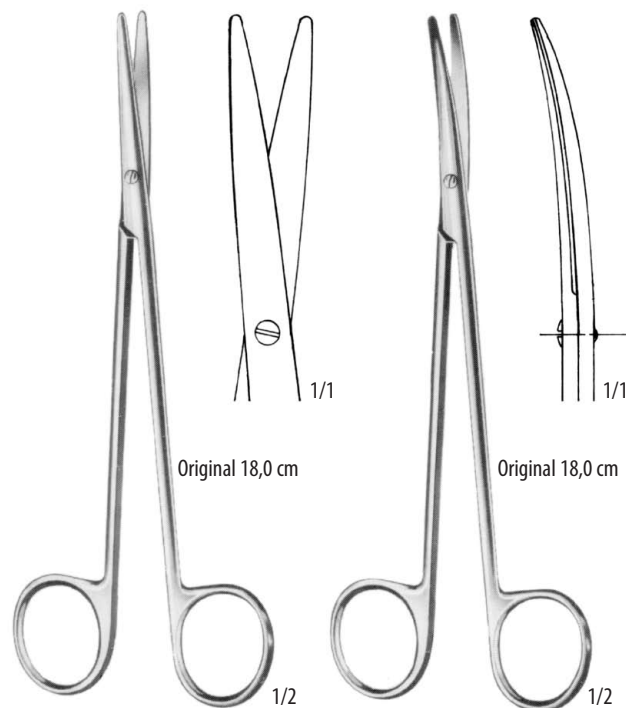
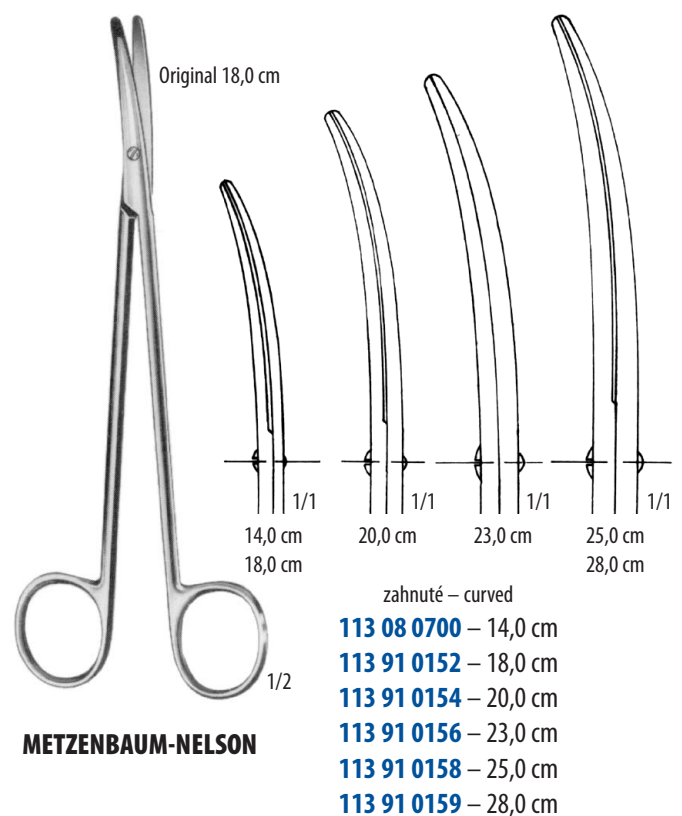
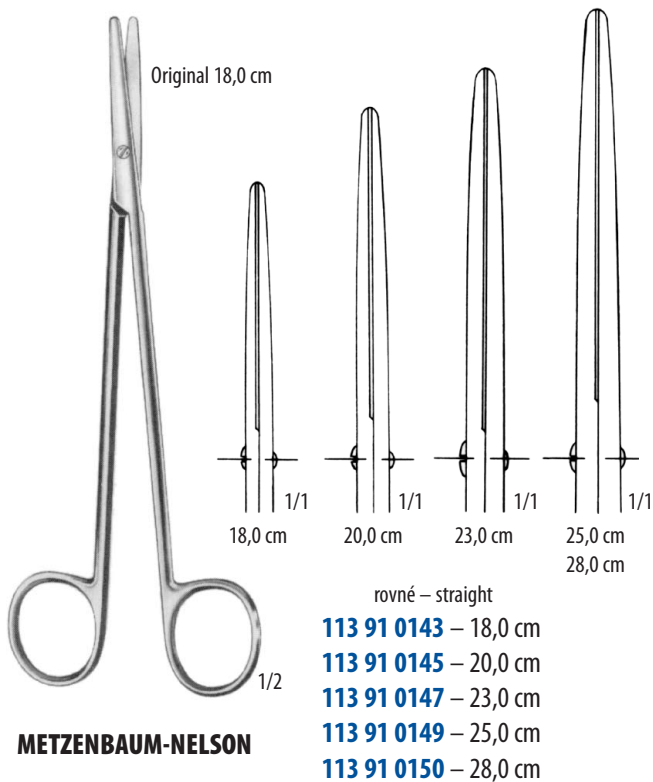

METZENBAUM-DELICATE

rovné – straight zahnuté – curved

113 91 0189 – 18,0 cm – **113 91 0195**
113 91 0190 – 20,0 cm – **113 91 0196**
113 91 0191 – 23,0 cm – **113 91 0197**
113 91 0192 – 25,0 cm – **113 91 0198**

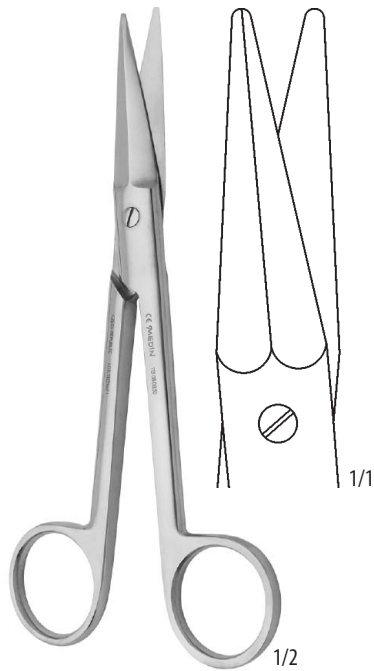

MAYO
113 08 0830
rovné – straight
17,0 cm

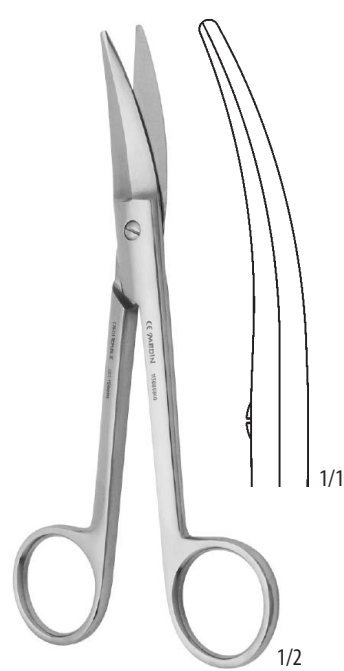

MAYO
113 08 0840
zahnuté – curved
16,8 cm

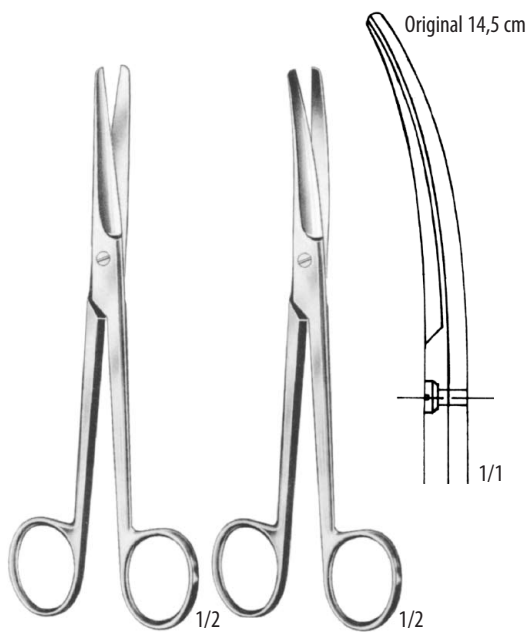

MAYO
rovné – straight zahnuté – curved
113 91 0083 – 14,5 cm – **113 91 0090**
113 91 0087 – 23,0 cm – **113 91 0094**

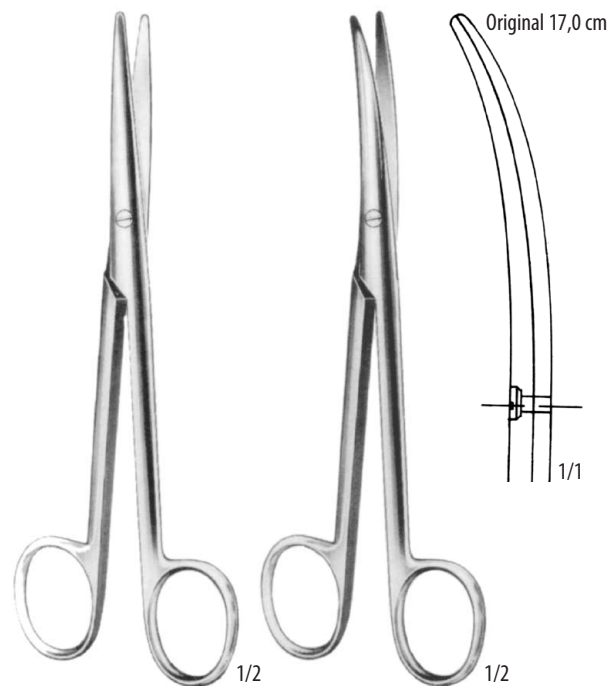

MAYO-STILLE
rovné – straight zahnuté – curved
113 91 0097 – 15,0 cm – **113 91 0101**
113 91 0098 – 17,0 cm – **113 91 0102**

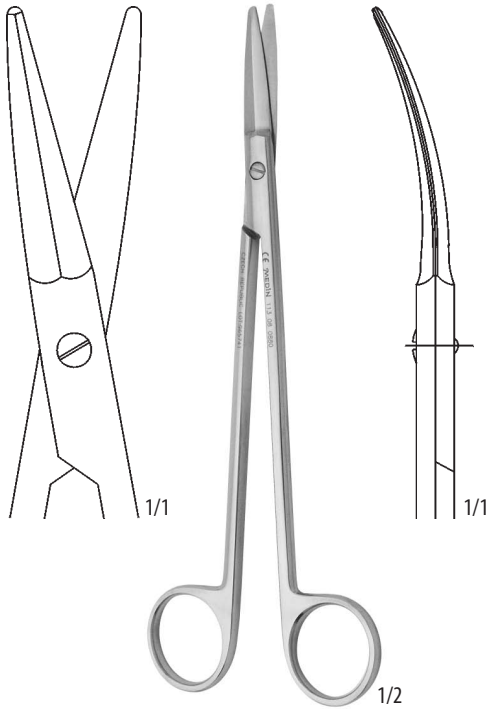

113 08 0880
rovné – straight
18,5 cm

113 08 0890
zahnuté – curved
18,5 cm

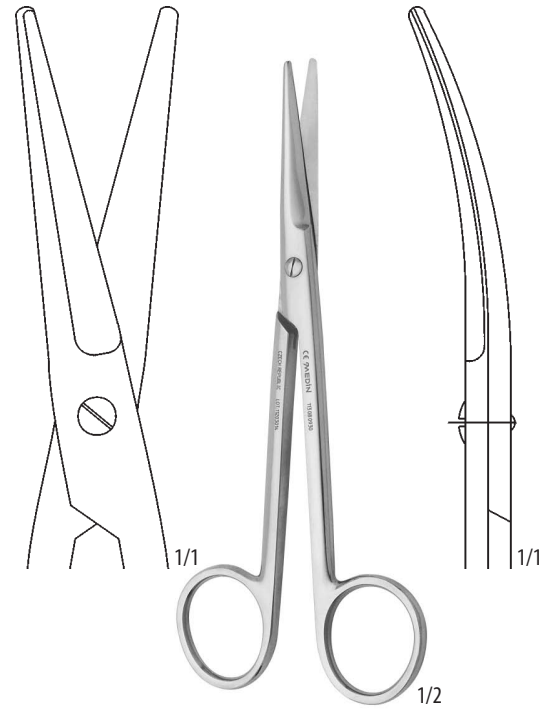

113 08 0930
rovné – straight
17,0 cm

113 08 0940
zahnuté – curved
17,0 cm

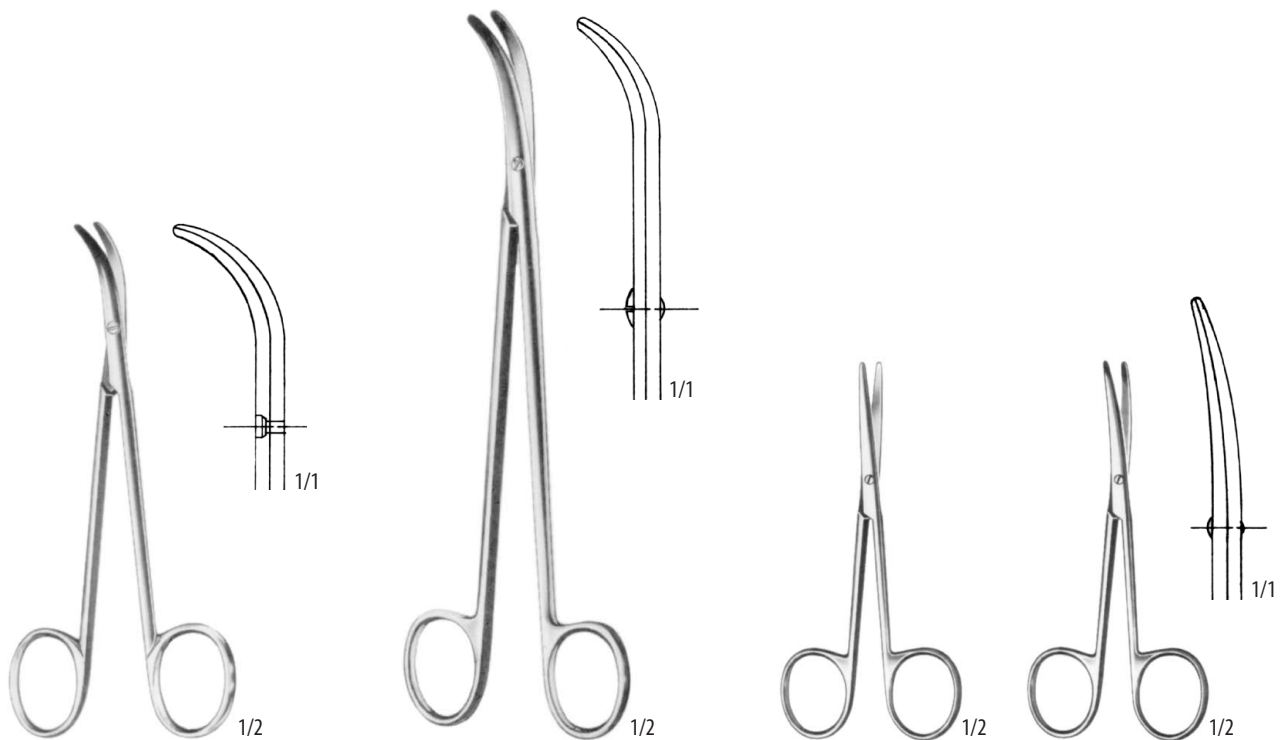

FOMON
113 91 0217
13,5 cm

THOREK
113 91 0218
19,0 cm

LEXER-BABY
113 91 0219
rovné – straight
10,0 cm

LEXER-BABY
113 91 0220
zahnuté – curved
10,0 cm

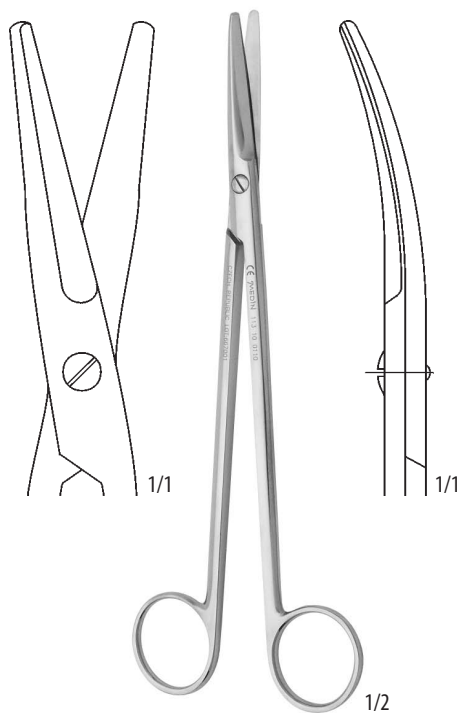

113 10 0110
rovné – straight
18,5 cm

113 10 0120
zahnuté – curved
18,5 cm

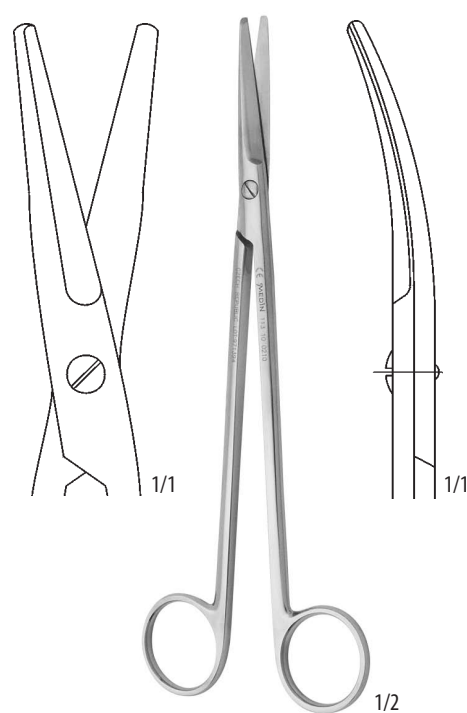

113 10 0210
rovné – straight
18,5 cm

113 10 0220
zahnuté – curved
18,5 cm



LEXER
113 91 0215
16,0 cm

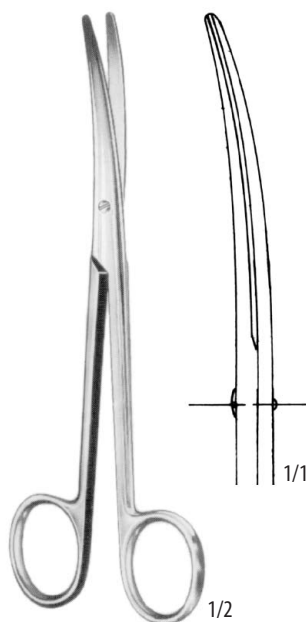

LEXER
113 91 0216
16,0 cm

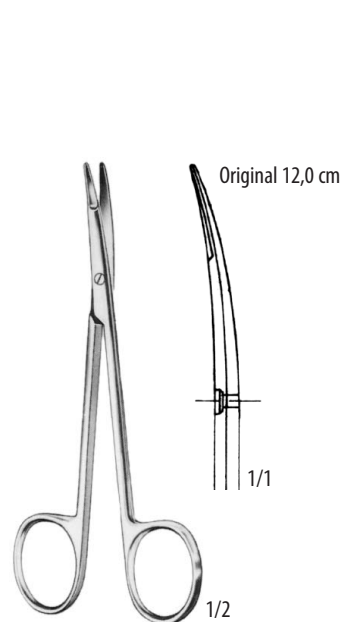

KILNER (RAGNELL)
113 91 0229
12,0 cm
113 91 0230
15,0 cm



SANVENERO
rovné – straight
113 91 0221
14,0 cm

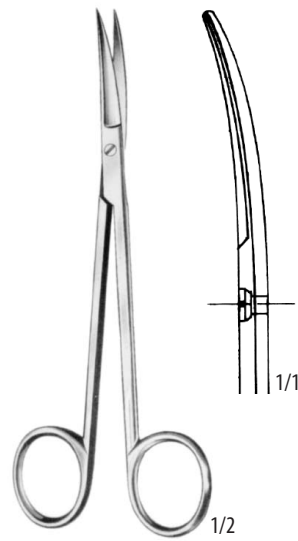

SANVENERO
zahnuté – curved
113 91 0222
14,0 cm



REYNOLDS
113 91 0233
rovné – straight
15,0 cm

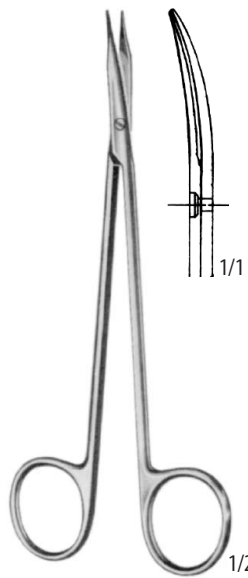

REYNOLDS
113 91 0235
zahnuté – curved
15,0 cm

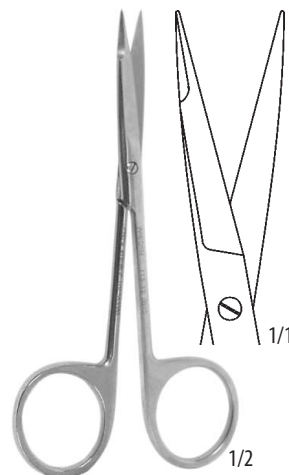

113 12 0010
rovné – straight
12,0 cm

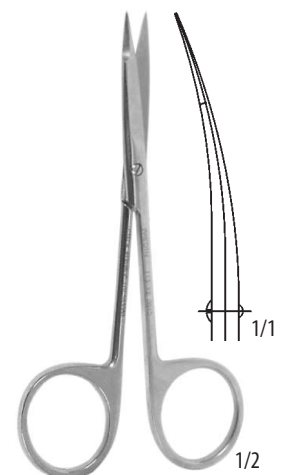

113 12 0020
zahnuté – curved
12,0 cm

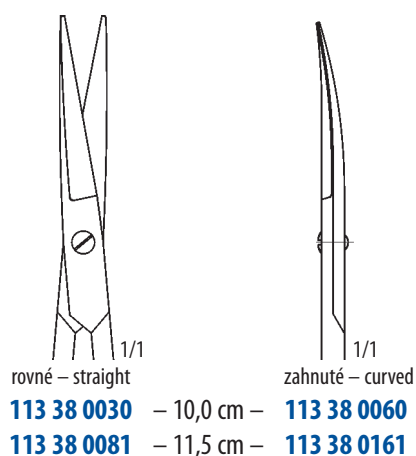
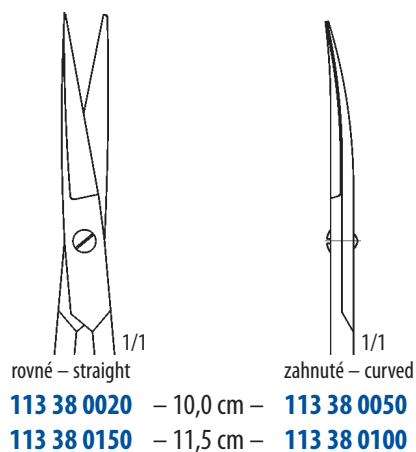
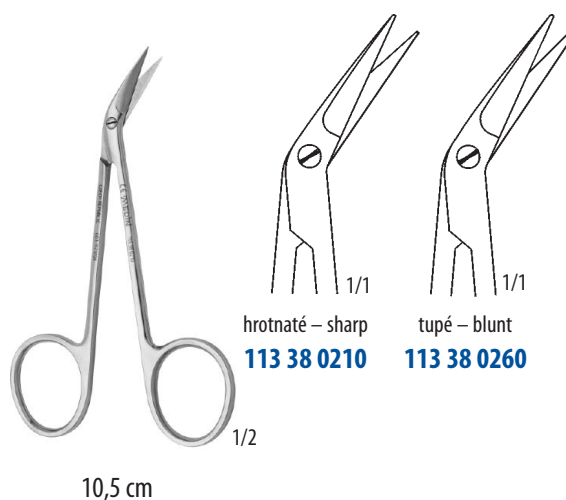
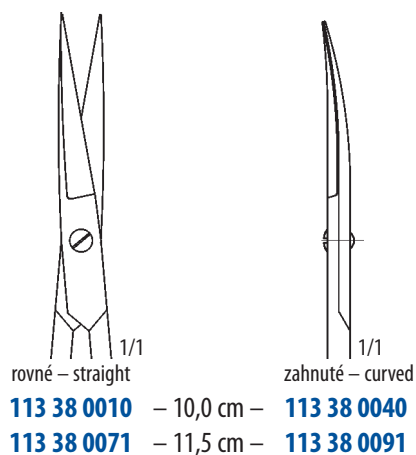



114 08 0090
 14,5 cm



114 08 0231
 velmi jemná – very fine
 14,5 cm



114 08 0140
 jemná – fine
 20,0 cm



114 08 0240
 velmi jemná – very fine
 20,0 cm



114 08 0250
 24,5 cm

PINZETY BIPOLÁRNÍ
BIPOLAR FORCEPS

1,2 mm

114 08 1470

22,5 cm



0,7 mm

114 08 1480

22,5 cm

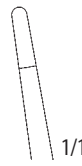

2 mm

114 08 1490

22,5 cm

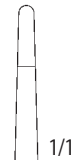

2 mm

114 08 1500

19,5 cm



1,2 mm

114 08 1510

19,5 cm

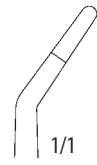

2 mm

114 08 1530

19,3 cm

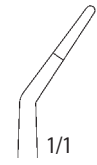

1,2 mm

114 08 1540

19,3 cm

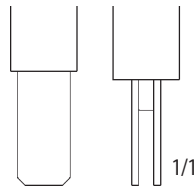

1/2

1/1

bajonetová – bay-shaped



1/2

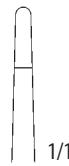

2 mm

114 08 1560

16,5 cm



1,2 mm

114 08 1570

16,5 cm

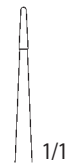

0,7 mm

114 08 1580

16,5 cm

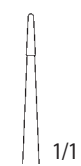

0,7 mm

114 08 1720

11,5 cm

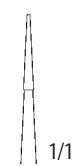

0,4 mm

114 08 1730

11,5 cm

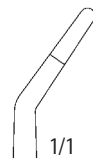

2 mm

114 08 1690

16,5 cm

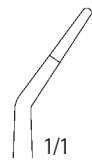

1,2 mm

114 08 1700

16,5 cm

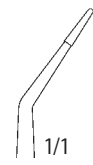

0,7 mm

114 08 1710

16,5 cm

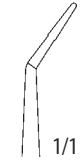

0,7 mm

114 08 1750

11,5 cm

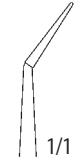

0,4 mm

114 08 1760

11,5 cm



1/2



1/2



1/2

MICRO-BULLDOG
115 14 0010

2,6 cm



1/2

MICRO-BULLDOG
115 14 0020

2,4 cm

 4x5
1/1

ALLIS
115 91 0364

15,0 cm

 5x6
1/1

Original 15,0 cm

ALLIS
115 91 0365 – 15,0 cm

115 91 0366 – 19,0 cm

115 91 0367 – 25,0 cm

Original 18,0 cm

1/2

BABCOCK

1/1

115 91 0382

16,0 cm

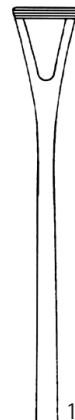

1/1

115 91 0384

18,0 cm



1/1

115 91 0385

20,0 cm

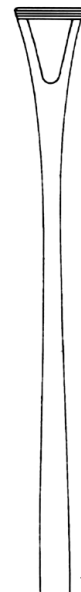

1/1

115 91 0386

24,0 cm



Original 5,0 cm

1/1

DIEFFENBACH

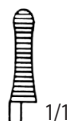

1/1

115 91 0031
3,5 cm

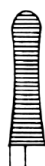

1/1

115 91 0032
5,0 cm



1/1

115 14 0150
6,5 cm



1/1

115 91 0034
3,5 cm



1/1

115 91 0035
5,0 cm



1/1

115 14 0160
6,5 cm



1/2

JOHNS-HOPKINS

115 91 0037

24,5 cm



Original 6,5 cm

1/1

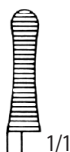

1/1

115 91 0039
5,0 cm

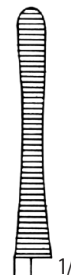

1/1

115 91 0040
6,5 cm

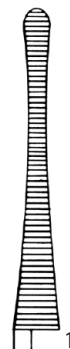

1/1

115 91 0041
7,5 cm

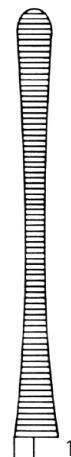

1/1

115 91 0042
9,0 cm

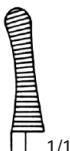

1/1

115 91 0044
5,0 cm

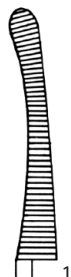

1/1

115 91 0045
6,5 cm



1/1

115 91 0046
7,5 cm



1/1

115 91 0047
9,0 cm



CHAPUT
115 91 0048
 13,0 cm



TUFFIER
115 91 0049
 13,0 cm

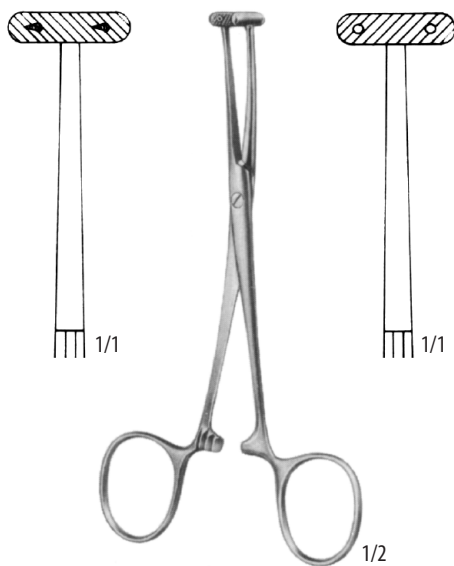

MARTEL
115 91 0050
 14,0 cm

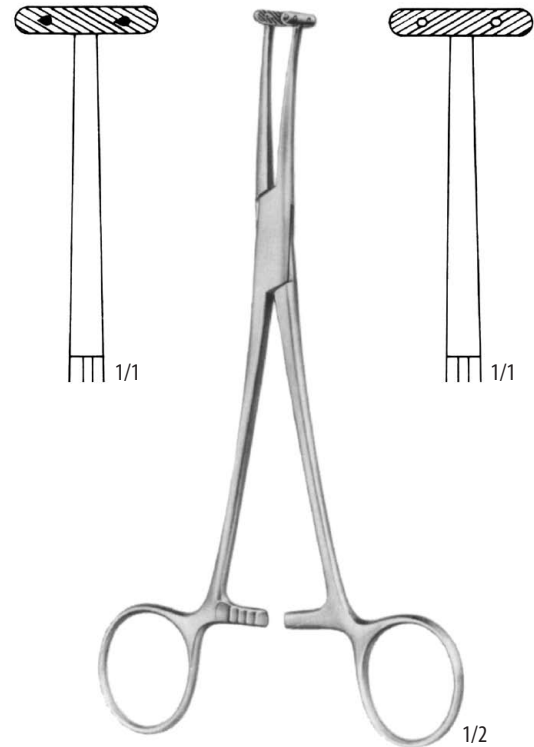

WILLET-MARTEL
115 91 0051
 19,0 cm

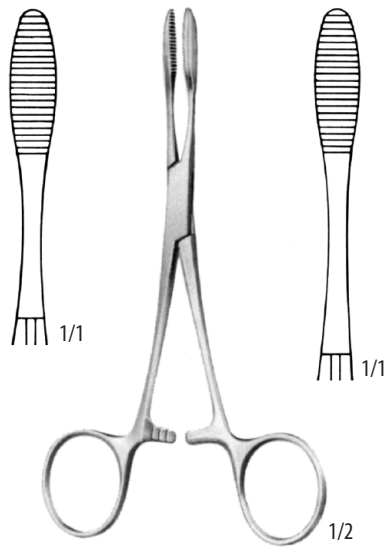

115 91 0052
14,0 cm

PEAN

115 91 0053
16,0 cm



115 08 0071
17,5 cm

PEAN

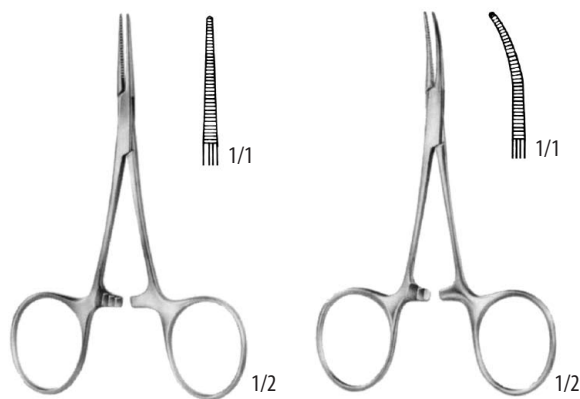

115 91 0068
10,0 cm

HARTMANN

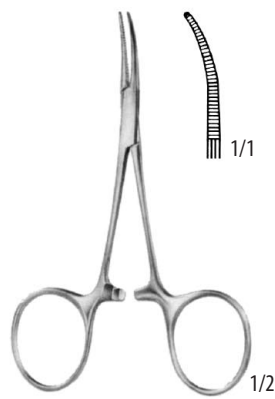

115 91 0069
10,0 cm

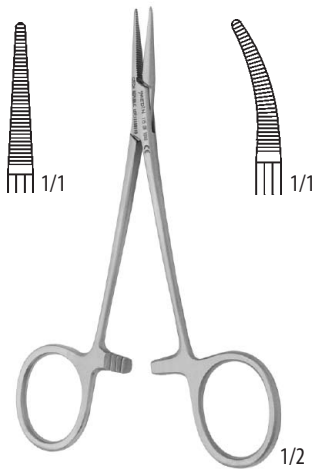

MOSQUITO-HALSTED
 standard – standard

115 08 0010
 12,0 cm

115 08 0020
 12,0 cm

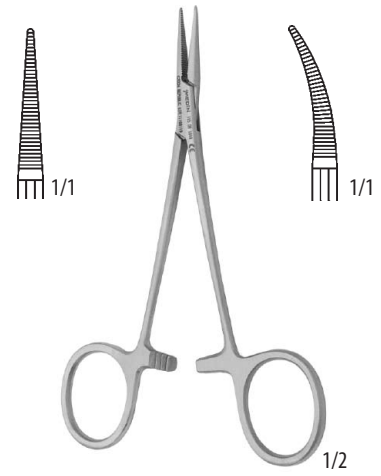

MOSQUITO-HALSTED
 jemné – fine

115 08 1010
 12,0 cm

115 08 1020
 12,0 cm

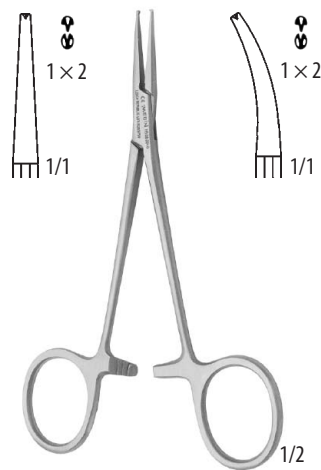

MOSQUITO-HALSTED
 hladká čelist – smooth jaw

115 08 0040
 12,0 cm

115 08 0060
 12,0 cm

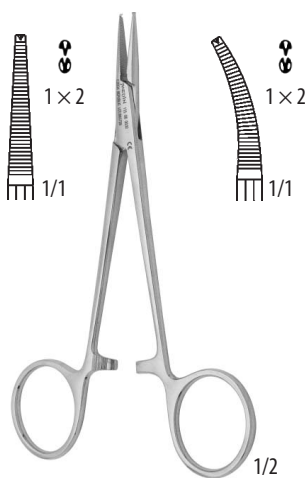

MOSQUITO-HALSTEAD
 standard – standard

115 08 0030
 12,0 cm

115 08 0050
 12,0 cm

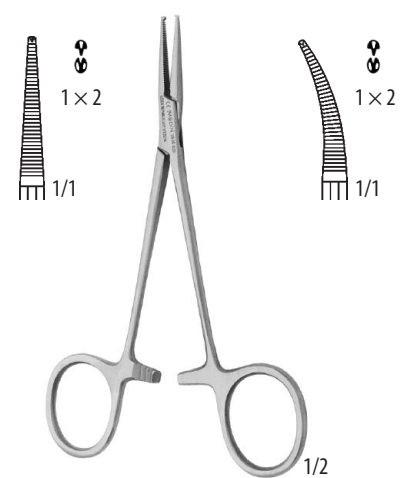

MOSQUITO-HALSTEAD
 jemné – fine

115 08 1030
 12,0 cm

115 08 1050
 12,0 cm

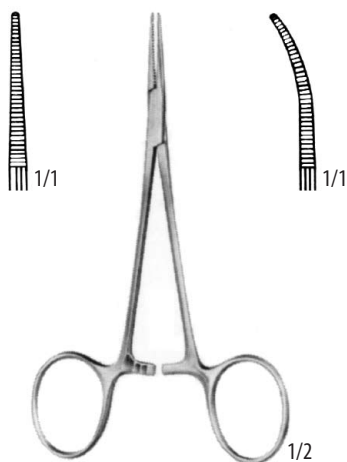
**MICRO-MOSQUITO****115 91 0073**

12,0 cm

115 91 0075

12,0 cm

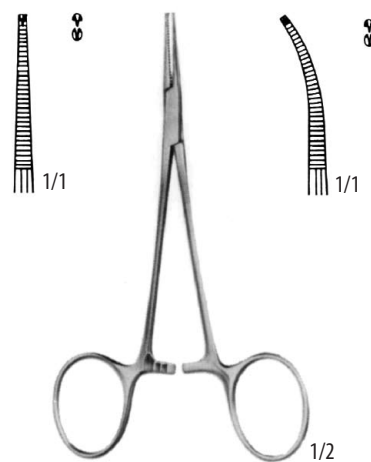
**MICRO-MOSQUITO****115 91 0077**

12,0 cm

115 91 0079

12,0 cm

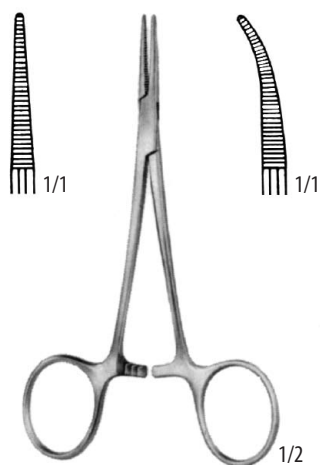
**HALSTEAD-MOSQUITO****115 91 0080**

12,0 cm

115 91 0082

12,0 cm

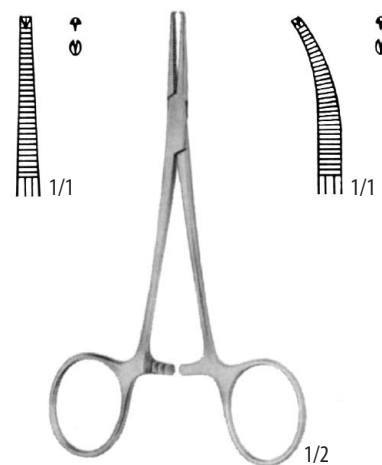
**HALSTEAD-MOSQUITO****115 91 0084**

12,0 cm

115 91 0086

12,0 cm

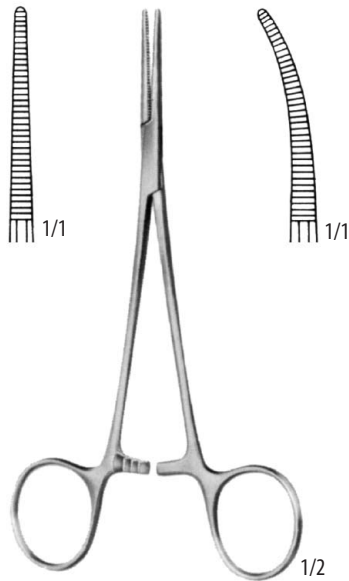
LERICHE
115 91 0097
15,0 cm

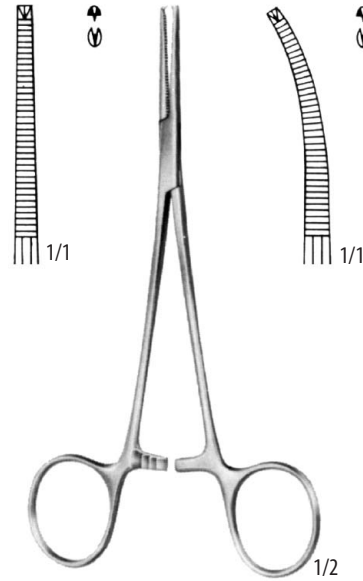
115 91 0098
15,0 cm

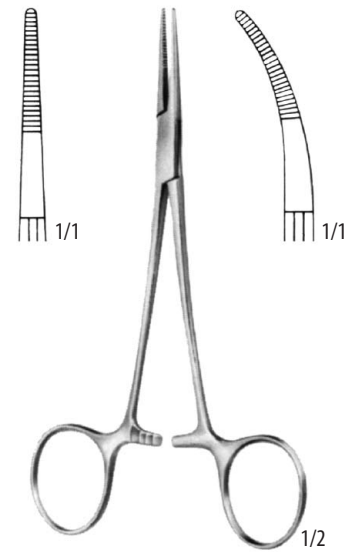
LERICHE
115 91 0099
15,0 cm

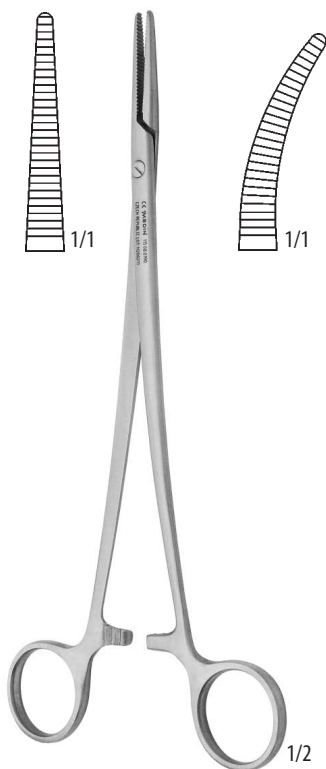
115 91 0100
15,0 cm

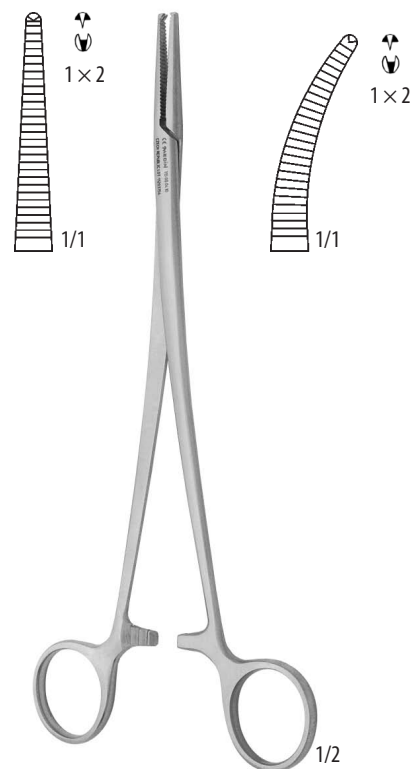
PROVIDENCE-HOSPITAL
115 91 0101
14,0 cm

115 91 0102
14,0 cm

PEAN
115 08 0190
20,0 cm

115 08 0200
20,0 cm

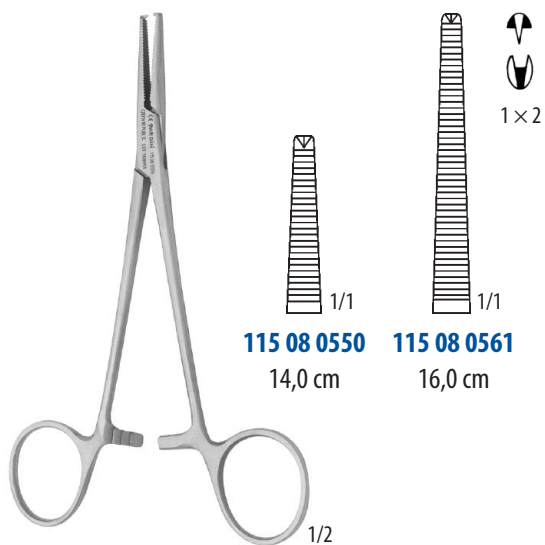
KOCHER
jemné – fine

115 08 0410
20,0 cm

115 08 0420
20,0 cm



115 08 0550
14,0 cm

115 08 0561
16,0 cm

ROCHESTER-OCHSNER

115 08 0561

16,0 cm

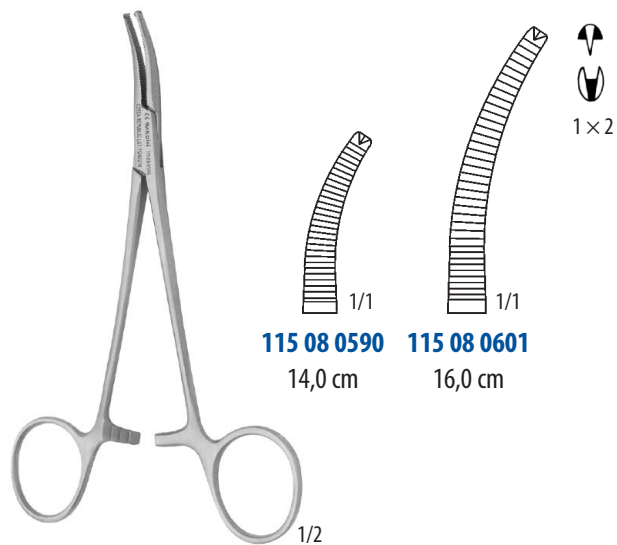

115 08 0590
14,0 cm

115 08 0601
16,0 cm

ROCHESTER-OCHSNER

115 08 0601

16,0 cm

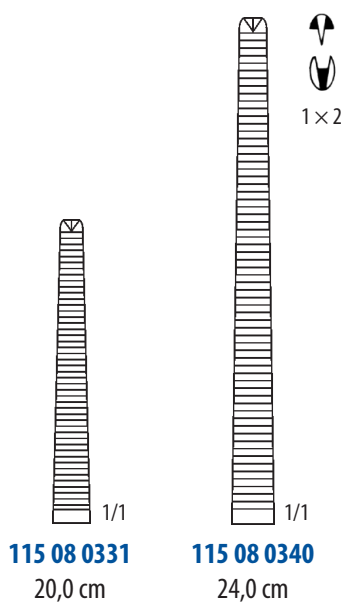

115 08 0331
20,0 cm

115 08 0340
24,0 cm



115 08 0381
20,0 cm

115 08 0390
24,0 cm

KOCHER

115 08 0381

20,0 cm

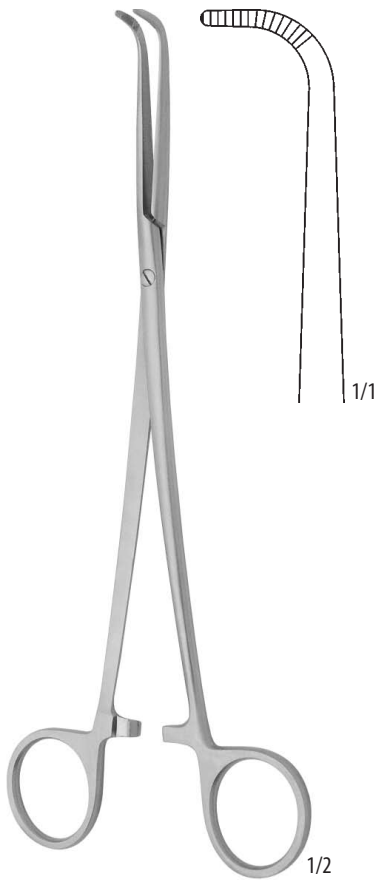

KELLY
115 08 0520
 22,5 cm

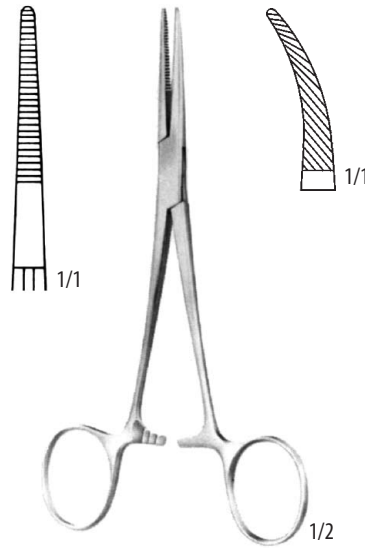

KELLY
115 91 0103 **115 08 0500**
 14,0 cm 14,0 cm

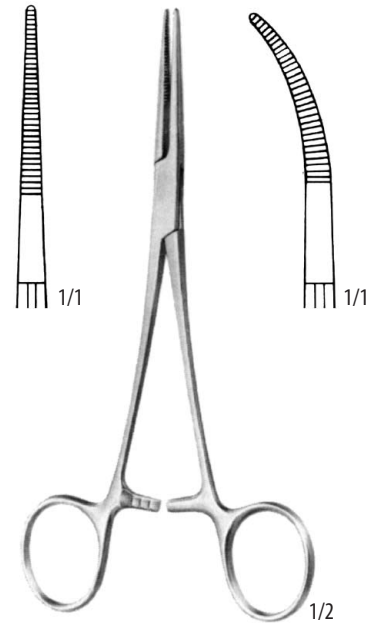

KELLY-RANKIN
115 91 0105 **115 91 0106**
 16,0 cm 16,0 cm

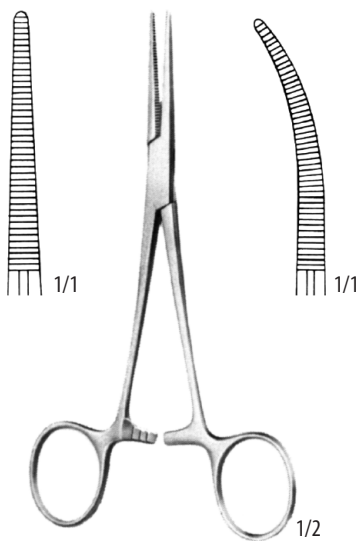

CRILE
115 91 0111 **115 91 0112**
 14,0 cm 14,0 cm

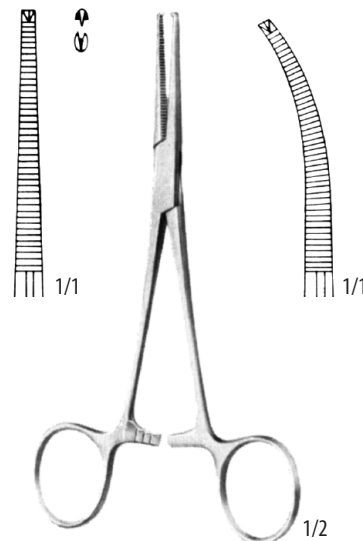

CRILE
115 91 0113 **115 91 0114**
 14,0 cm 14,0 cm

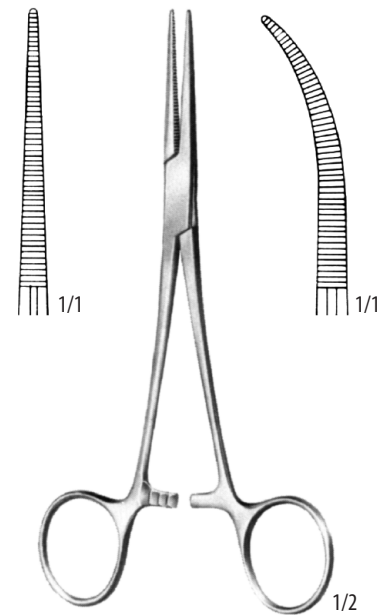

CRILE-RANKIN
115 91 0115 **115 91 0116**
 16,0 cm 16,0 cm

SVORKY NA CÉVY
ARTERY FORCEPS**ROCHESTER-PEAN****115 08 0231**

16,0 cm

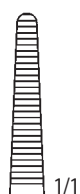

1/1

115 08 0220

14,0 cm

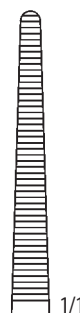

1/1

115 08 0231

16,0 cm

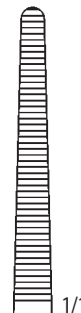

1/1

115 08 0121

20,0 cm

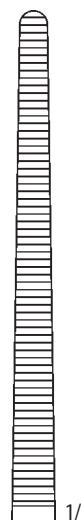

1/1

115 08 0130

24,0 cm

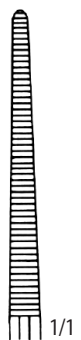

1/1

115 91 0117

14,0 cm

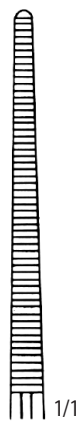

1/1

115 91 0118

16,0 cm

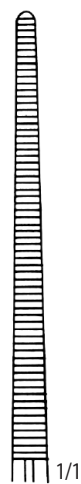

1/1

115 91 0119

18,0 cm

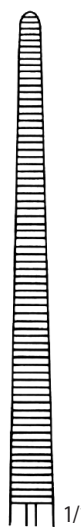

1/1

115 91 0120

20,0 cm

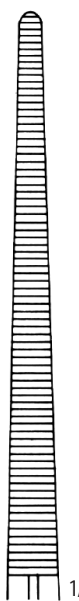

1/1

115 91 0121

22,0 cm

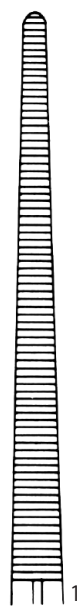

1/1

115 91 0122

24,0 cm

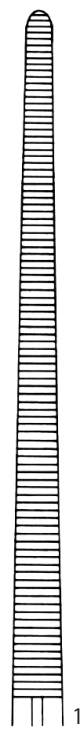

1/1

115 91 0123

26,0 cm

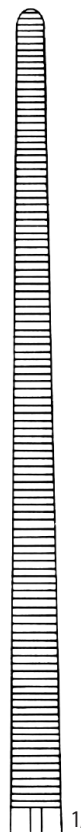

1/1

115 91 0124

30,0 cm

ROCHESTER-PEAN
115 08 0271

16,0 cm

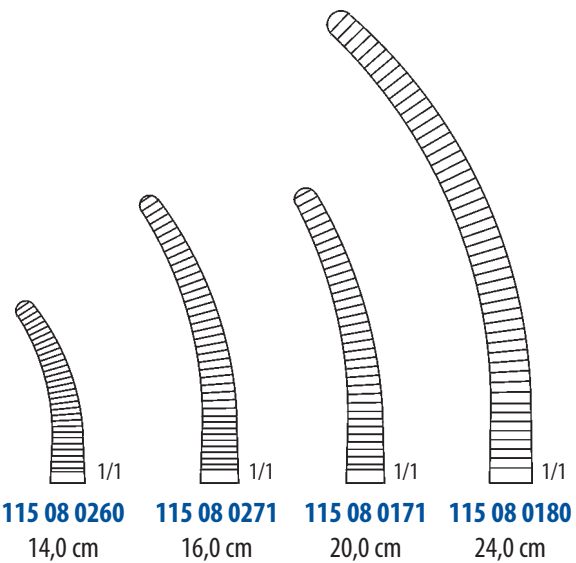
115 08 0260

14,0 cm

115 08 0271

16,0 cm

115 08 0171

20,0 cm

115 08 0180

24,0 cm

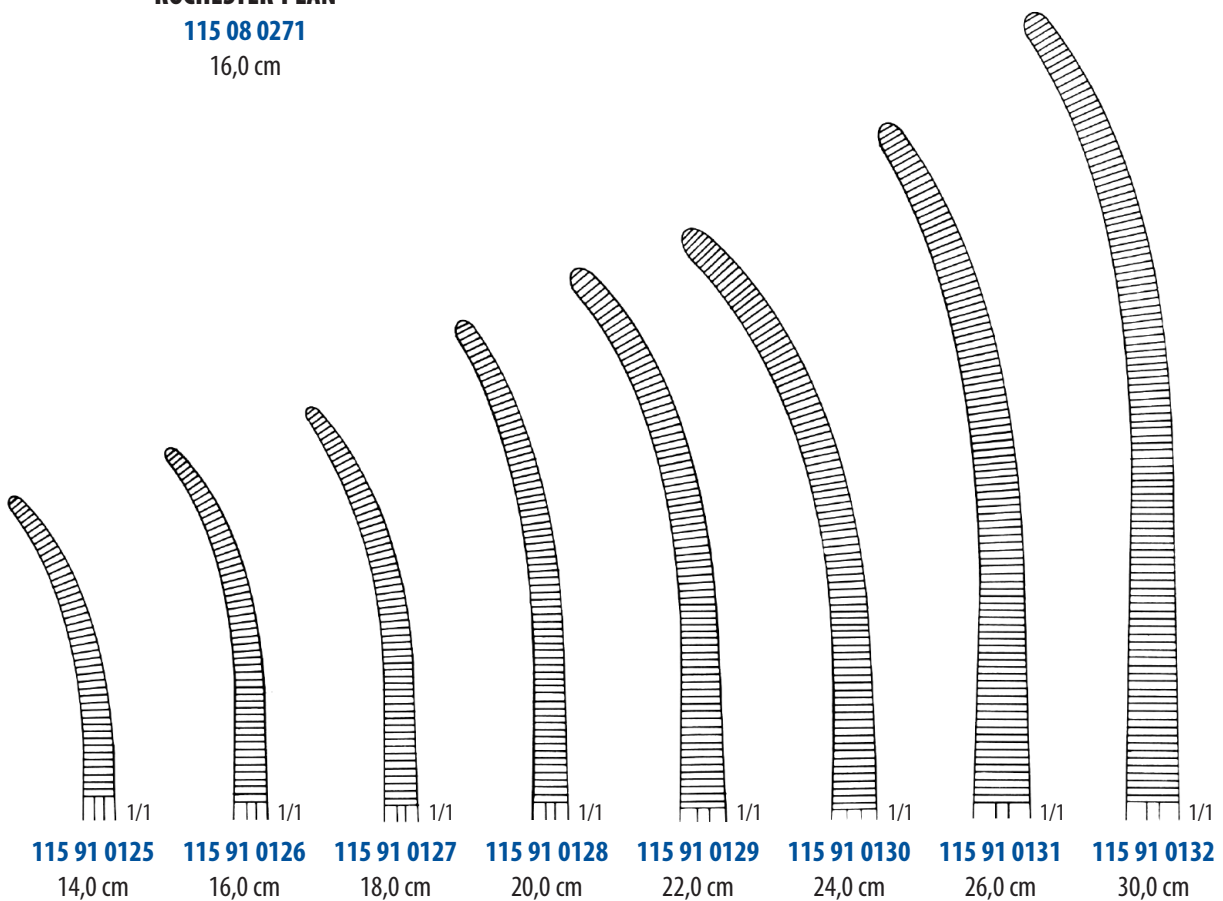
115 91 0125

14,0 cm

115 91 0126

16,0 cm

115 91 0127

18,0 cm

115 91 0128

20,0 cm

115 91 0129

22,0 cm

115 91 0130

24,0 cm

115 91 0131

26,0 cm

115 91 0132

30,0 cm

SVORKY NA CÉVY
ARTERY FORCEPS

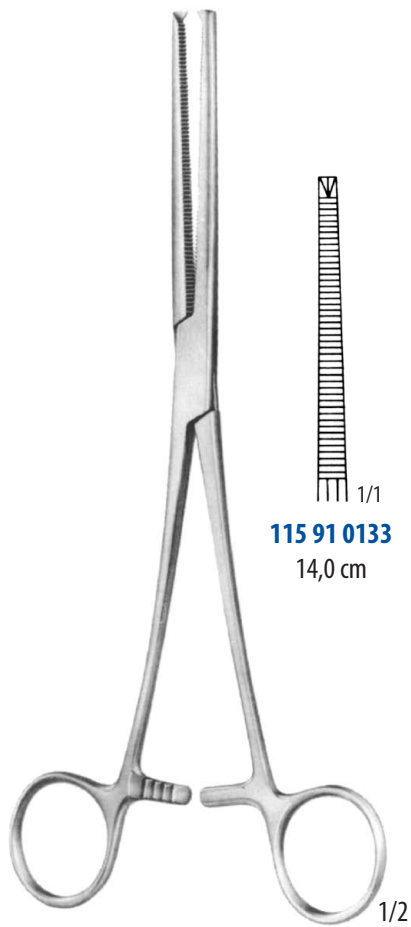

1/2

OCHSNER-KOCHER

115 91 0138

24,0 cm
1x2

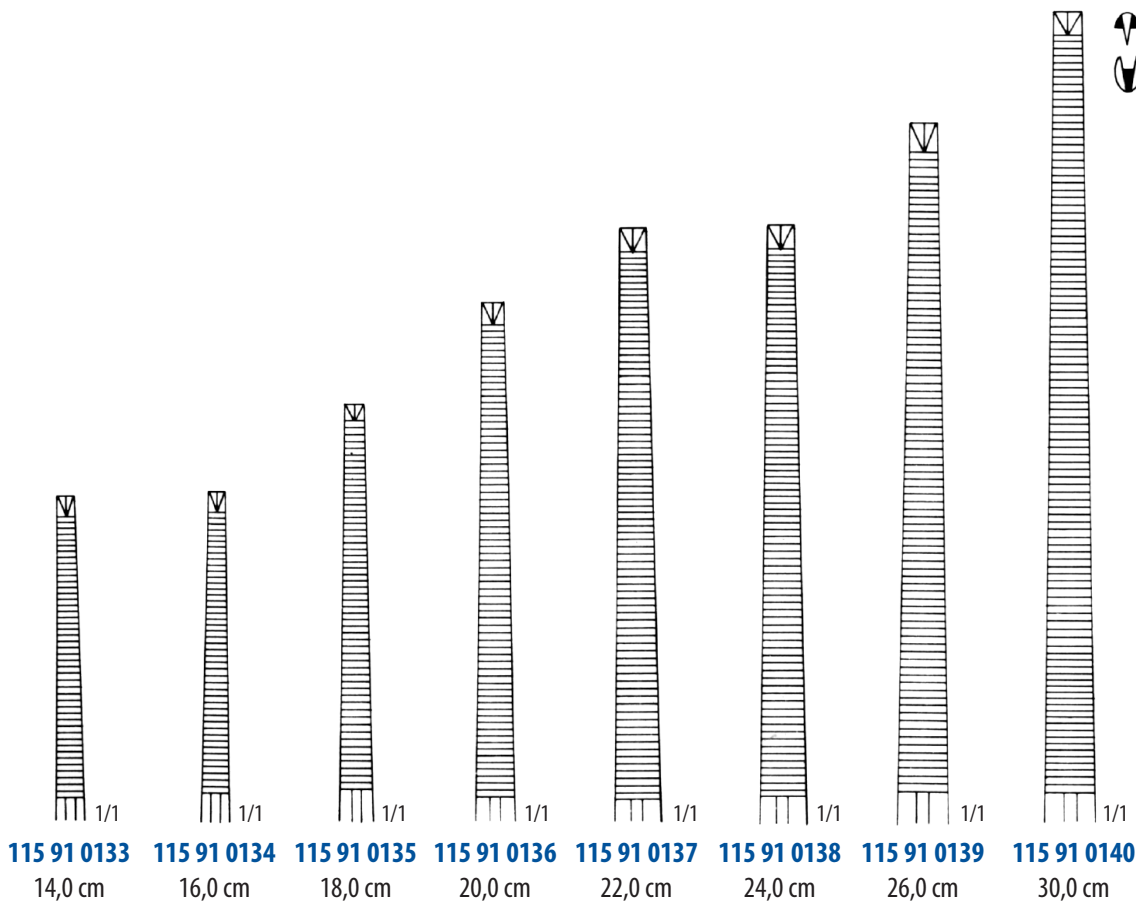

115 91 0133 14,0 cm **115 91 0134** 16,0 cm **115 91 0135** 18,0 cm **115 91 0136** 20,0 cm **115 91 0137** 22,0 cm **115 91 0138** 24,0 cm **115 91 0139** 26,0 cm **115 91 0140** 30,0 cm

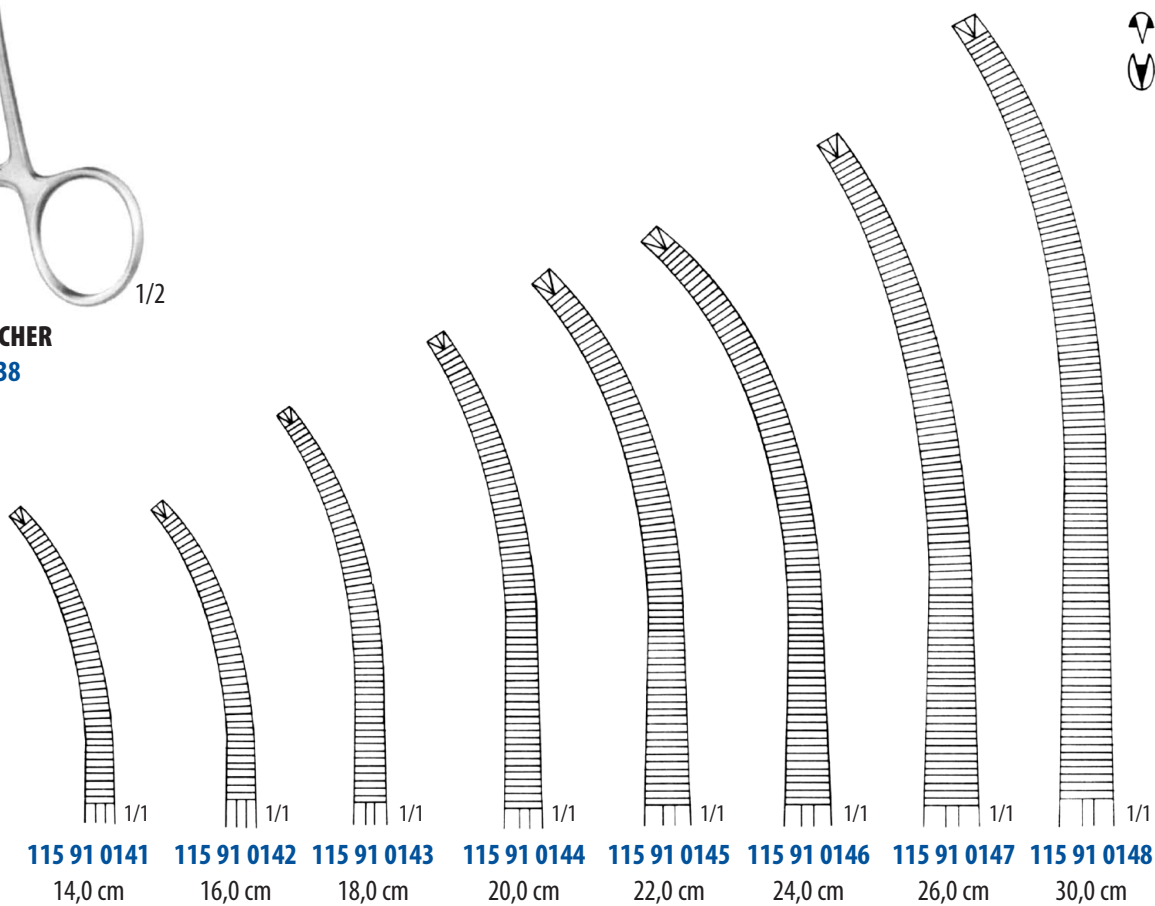

115 91 0141 14,0 cm **115 91 0142** 16,0 cm **115 91 0143** 18,0 cm **115 91 0144** 20,0 cm **115 91 0145** 22,0 cm **115 91 0146** 24,0 cm **115 91 0147** 26,0 cm **115 91 0148** 30,0 cm



OVERHOLT-GEISSENDOERFER
115 91 0161
21,0 cm

21,0 cm
27,0 cm

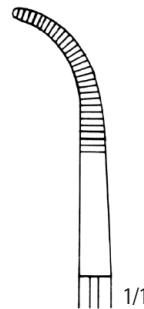

Fig. 1

115 91 0161
115 91 0168

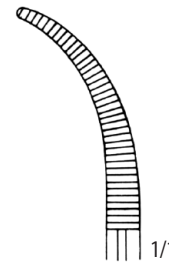

Fig. 2

115 91 0162
115 91 0169

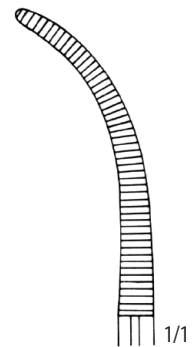

Fig. 3

115 91 0163
115 91 0170

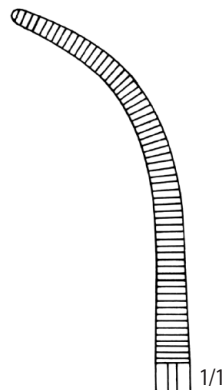

Fig. 4

21,0 cm **115 91 0164**
27,0 cm **115 91 0171**

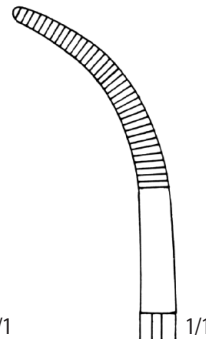

Fig. 5

115 91 0165
115 91 0172

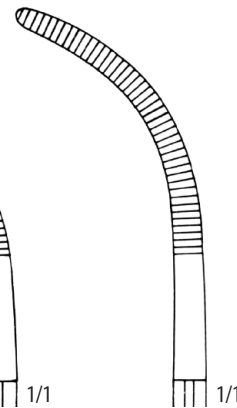

Fig. 6

115 91 0166
115 91 0173

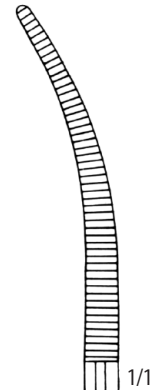
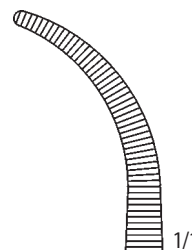

Fig. 7

115 91 0167
115 91 0174



OVERHOLT
19,5 cm



1/1

115 14 1150
19,5 cm
Fig. 1

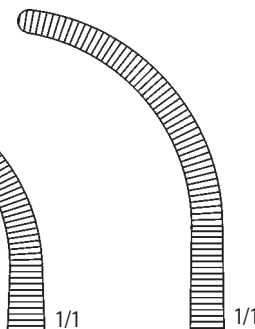

1/1

115 14 1160
22,2 cm
Fig. 2

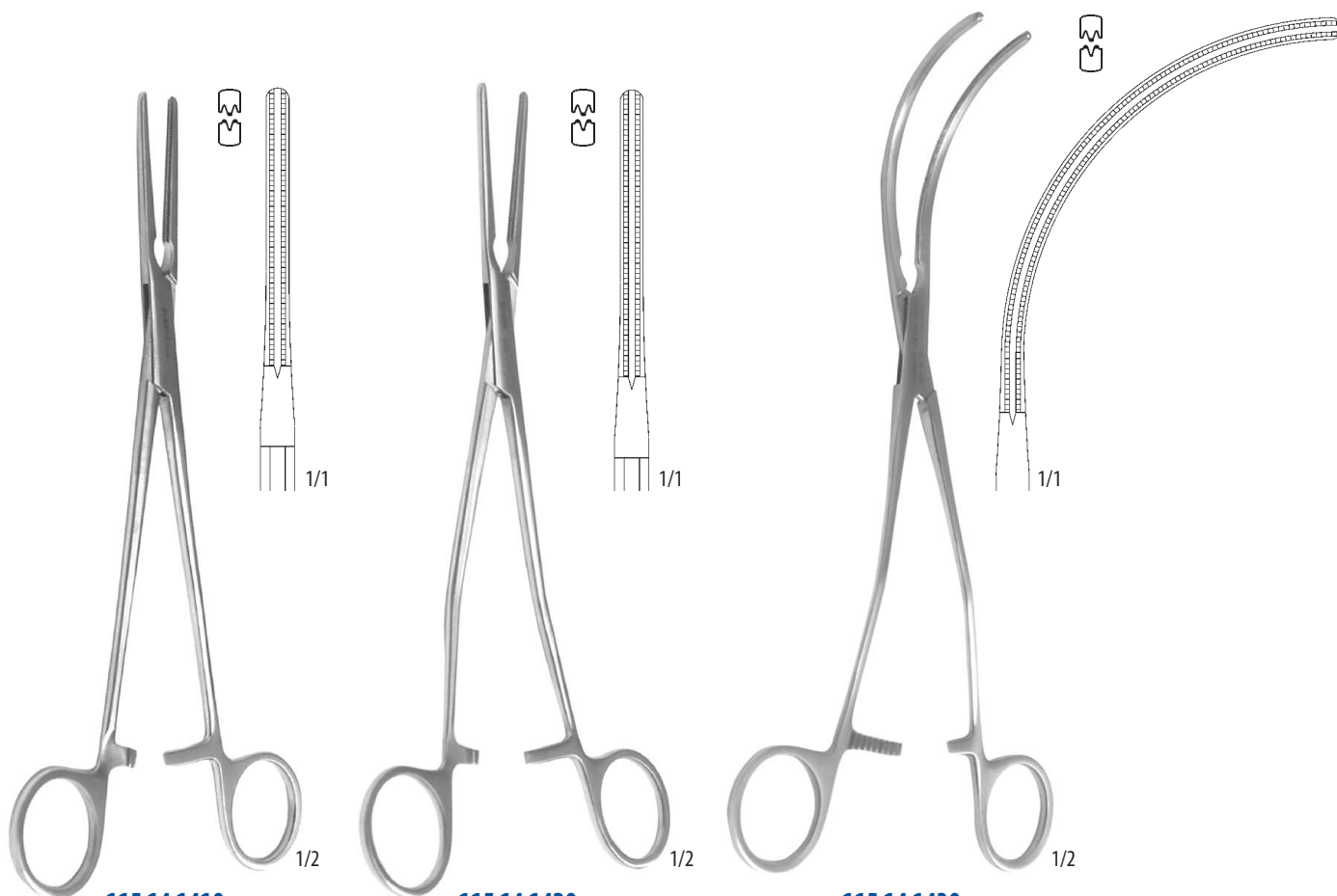
SVORKY ATRAUMATICKÉ NA CÉVY
ARTERY FORCEPS ATRAUMATIC JAWS
**115 14 1410**

22,0 cm

Fig. 1

115 14 1420

22,0 cm

Fig. 2

115 14 1430

23,5 cm

Fig. 3

**115 14 1440**

20,5 cm

Fig. 4

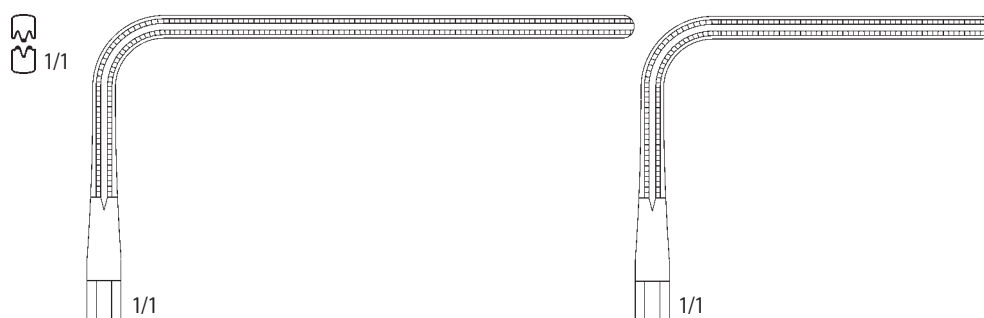
**115 14 1450**

20,5 cm

Fig. 5



115 14 1460
 22,0 cm
 Fig. 6

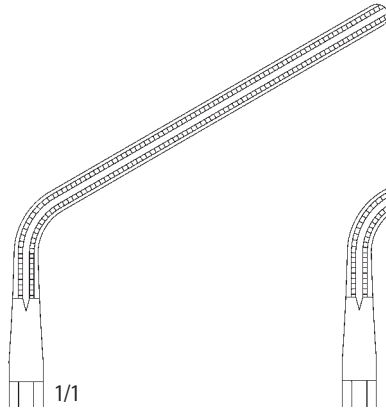

115 14 1470
 22,0 cm
 Fig. 7



115 14 1480
 22,4 cm
 Fig. 8

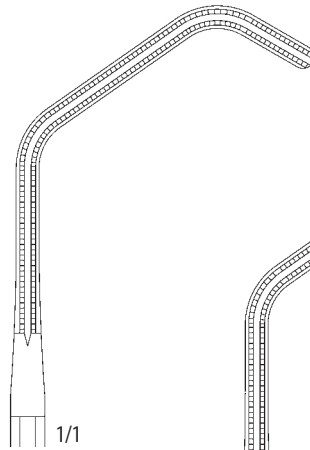

115 14 1490
 23,0 cm
 Fig. 9

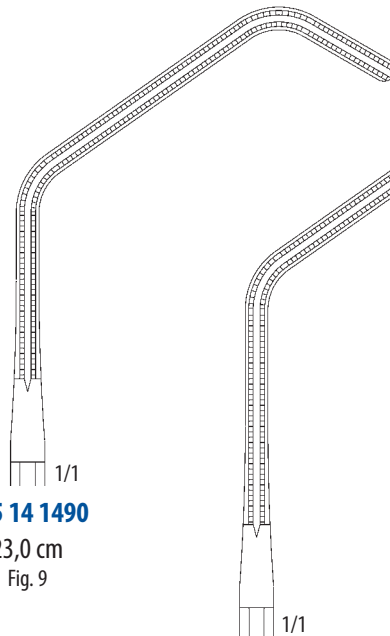

115 14 1500
 24,5 cm
 Fig. 10

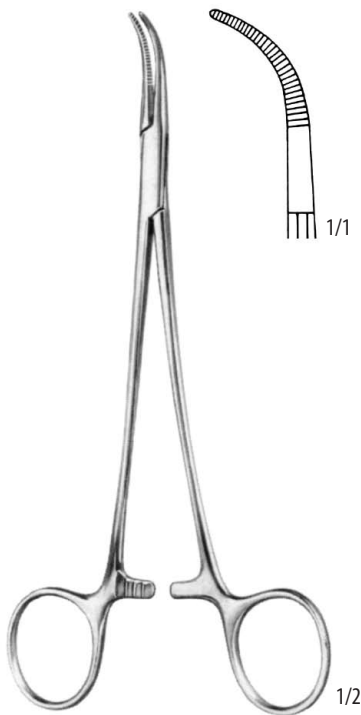

OVERHOLT
115 91 0176
18,5 cm



OVERHOLT
115 91 0177
20,5 cm

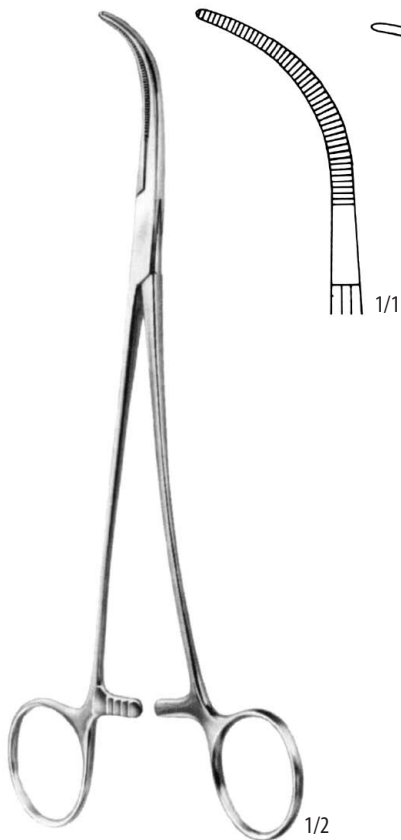

OVERHOLT
115 91 0178
21,0 cm

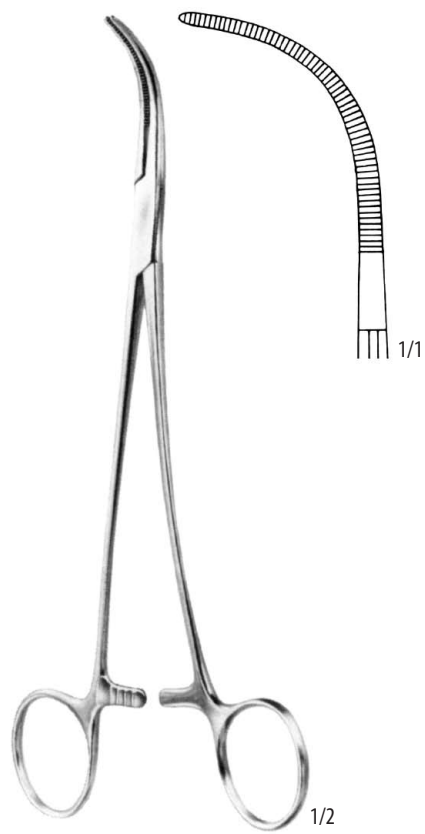
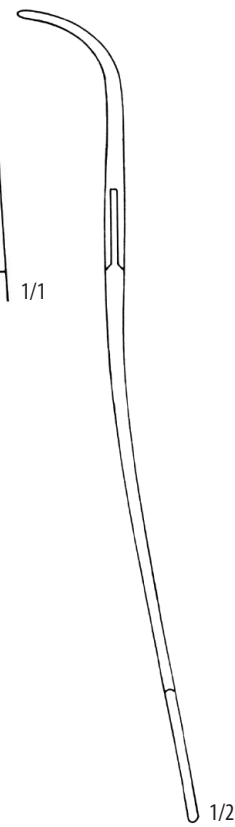

OVERHOLT
115 91 0179
21,5 cm

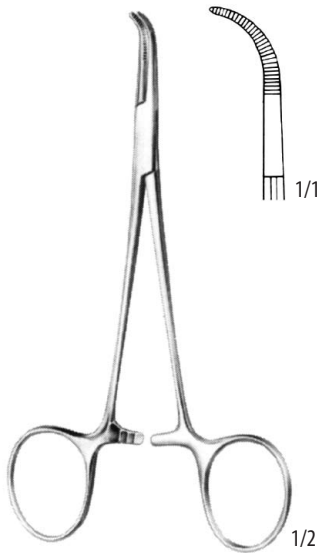

BABY-ADSON
115 91 0180
14,0 cm



BABY-ADSON
115 91 0181
18,0 cm

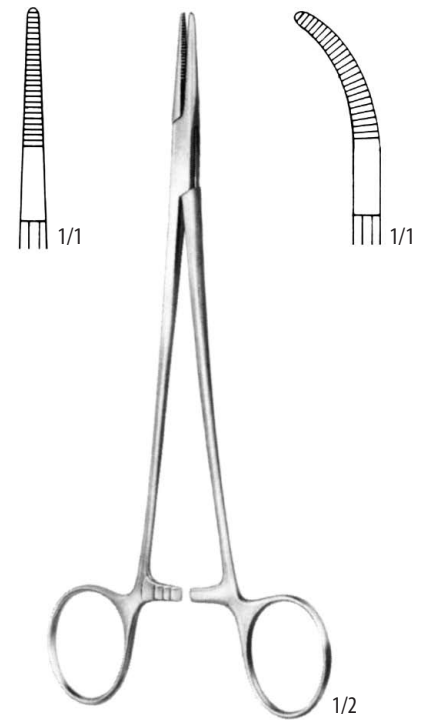

ADSON
115 91 0182
18,5 cm

115 91 0183
18,5 cm

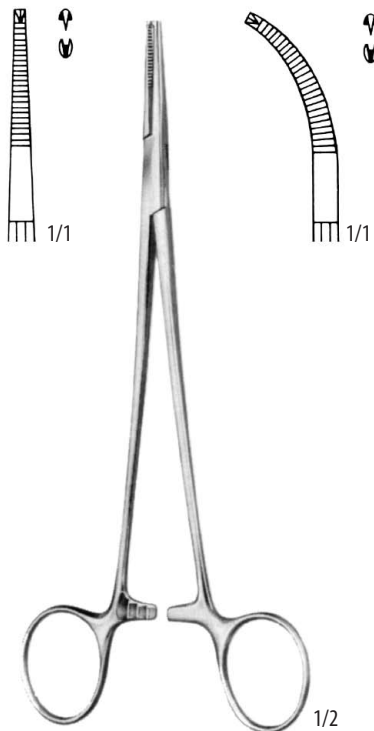

ADSON
115 91 0184
18,5 cm

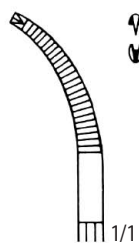

ADSON
115 91 0185
18,5 cm

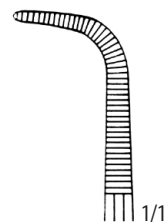

MEEKER
115 91 0186
18,0 cm

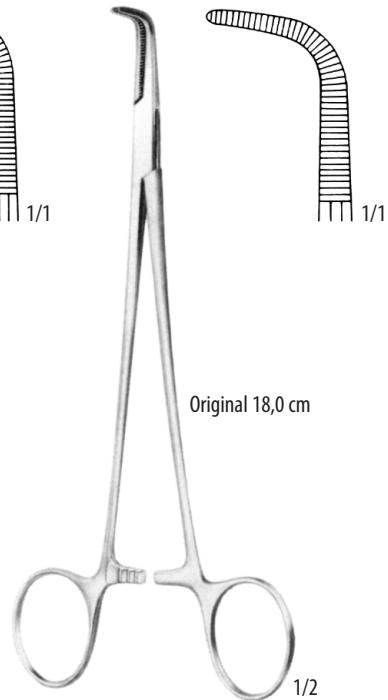

Original 18,0 cm

MEEKER
115 91 0187
28,0 cm

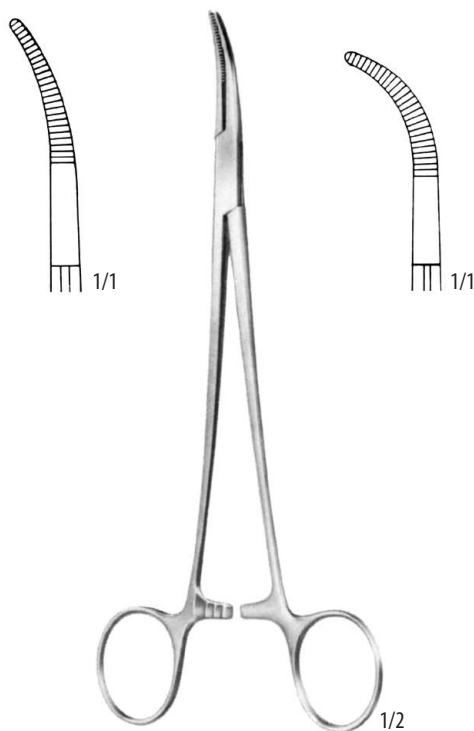
**SCHNIDT-SAWTELL**

115 91 0192
19,0 cm

115 91 0193
19,0 cm

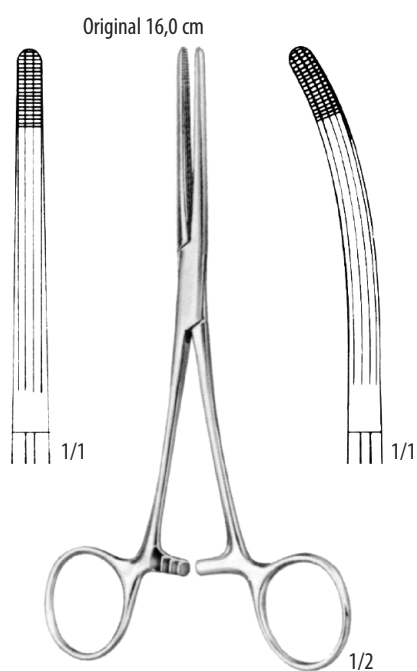
**ROCHESTER-CARMALT**

115 91 0196 – 16,0 cm – **115 91 0198**
115 91 0197 – 20,0 cm – **115 91 0199**

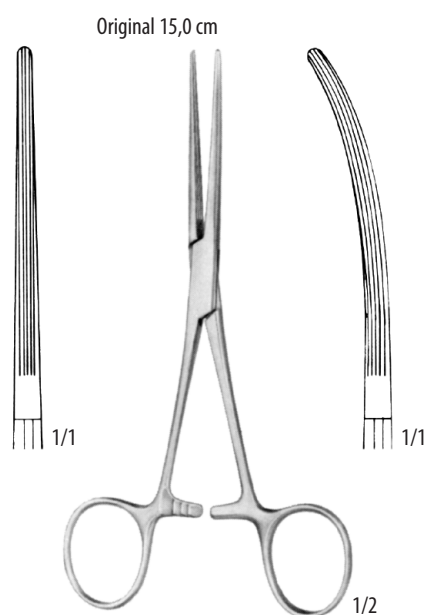
**BAINBRIDGE**

115 91 0200 – 15,0 cm – **115 91 0202**
115 91 0201 – 18,5 cm – **115 91 0203**



115 91 0204
115 91 0205

– 20,0 cm –
– 26,0 cm –

115 91 0206
115 91 0207

Original 20,0 cm

1/2

BENGOLEA

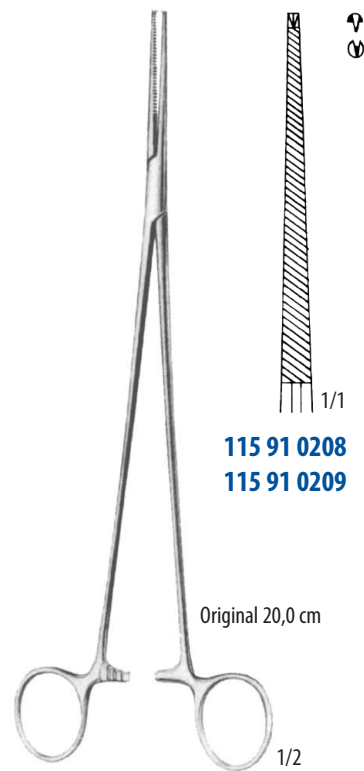

115 91 0208
115 91 0209

– 20,0 cm –
– 26,0 cm –

115 91 0210
115 91 0211

Original 20,0 cm

1/2

BENGOLEA



Original 24,0 cm

1/2

GRAFOORD-SELLORS

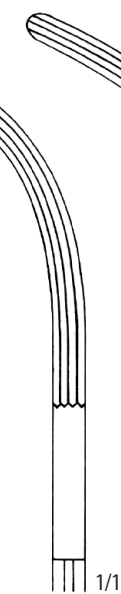

115 91 0212
22,0 cm

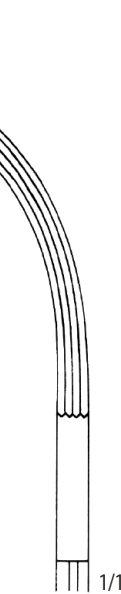

115 91 0213
23,0 cm



115 91 0214
24,0 cm

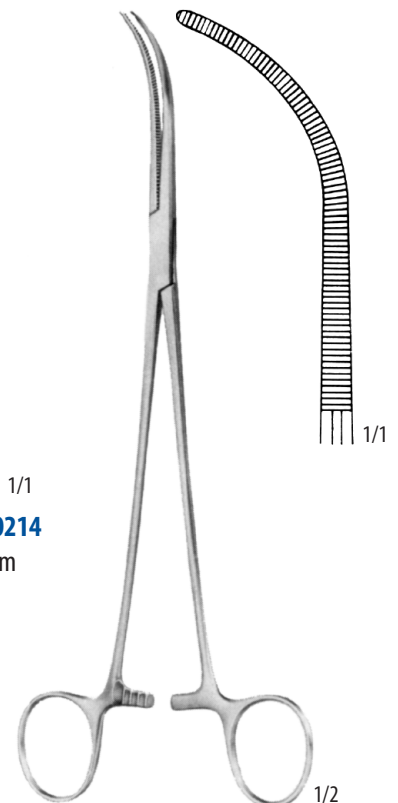

OVERHOLT-MIXTER

115 91 0215
21,0 cm

SVORKY NA CÉVY
ARTERY FORCEPS

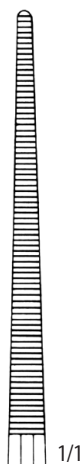

1/1

115 91 0219
22,0 cm

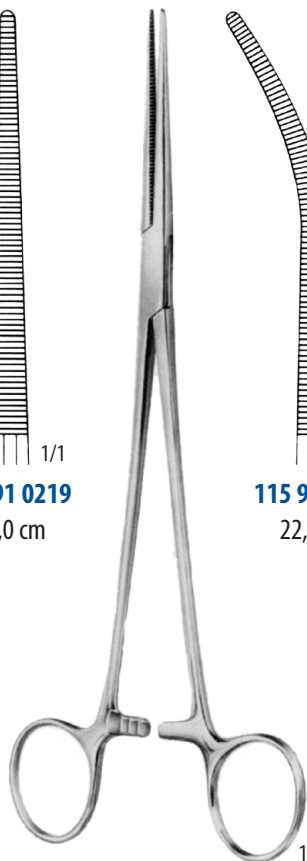

1/2

ROBERTS

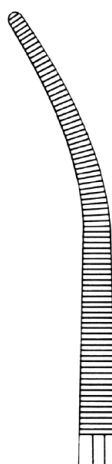

1/1

115 91 0220
22,0 cm

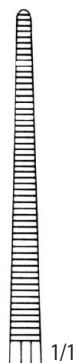

1/1

115 91 0216
20,0 cm
Fig. 1

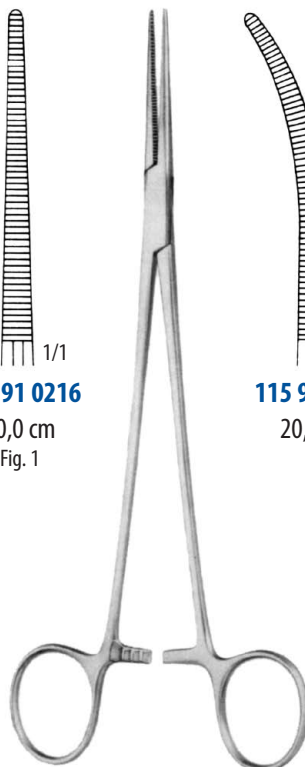

1/2

HEISS

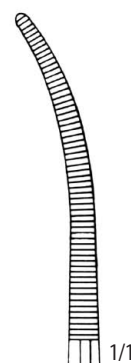

1/1

115 91 0217
20,0 cm



1/1

115 91 0218
20,0 cm

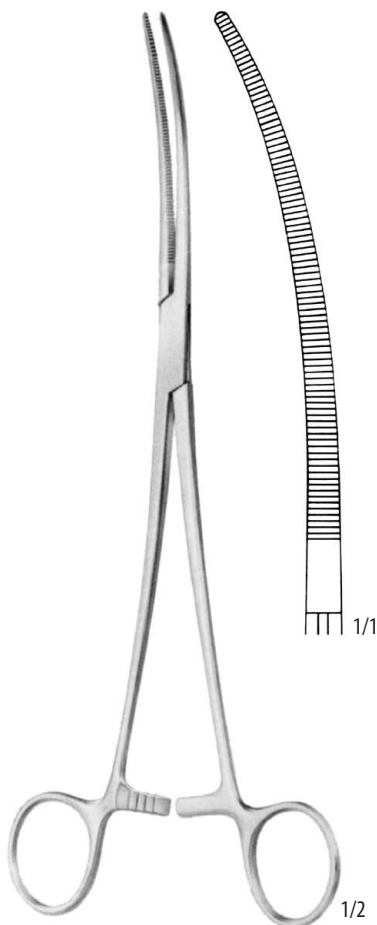

1/2

CRAFOORD
115 91 0223
24,0 cm

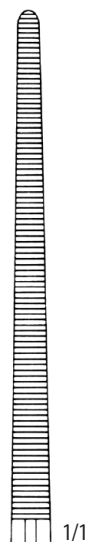

1/1

115 91 0221
24,0 cm

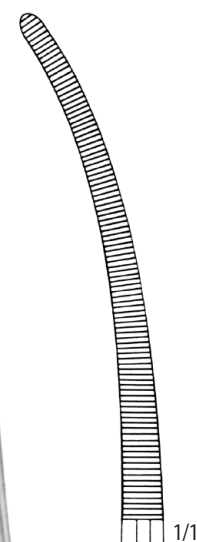

1/1

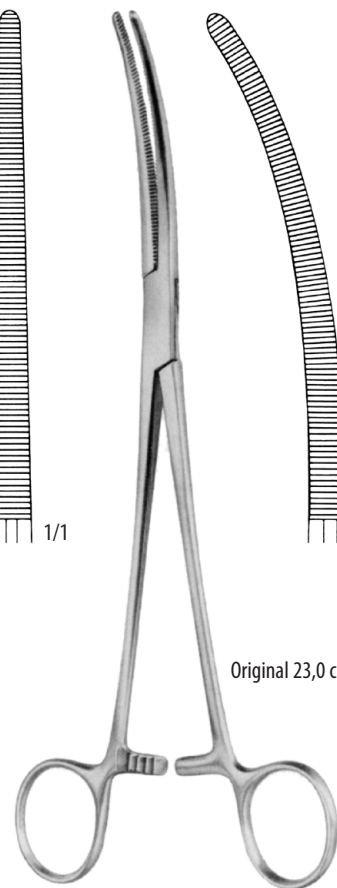

1/2

SAROT
115 14 1600
23,0 cm

Original 23,0 cm



RUMEL
23,0 cm

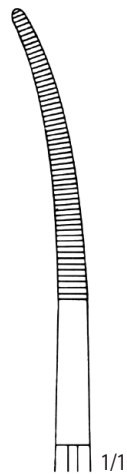

115 91 0224
23,0 cm
Fig. 1

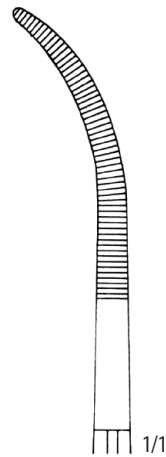

115 91 0225
23,0 cm
Fig. 2

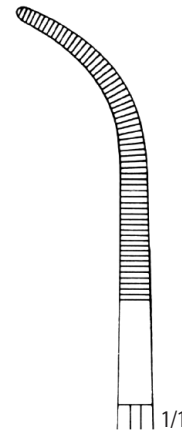

115 91 0226
23,0 cm
Fig. 3

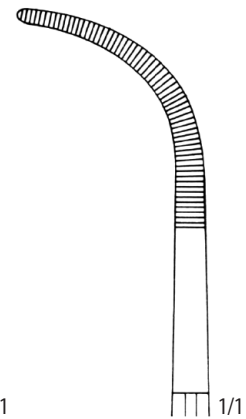

115 91 0227
23,0 cm
Fig. 4



ZENKER
29,5 cm

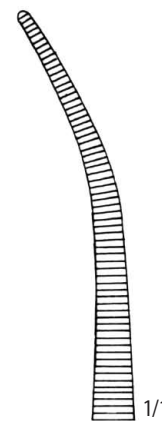

115 91 0229
29,5 cm

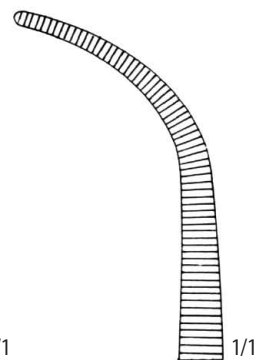

115 91 0230
29,5 cm

**BRIDGE**

115 91 0242
28,0 cm

115 91 0243
28,0 cm

**LAWRENCE**

115 91 0244
28,0 cm

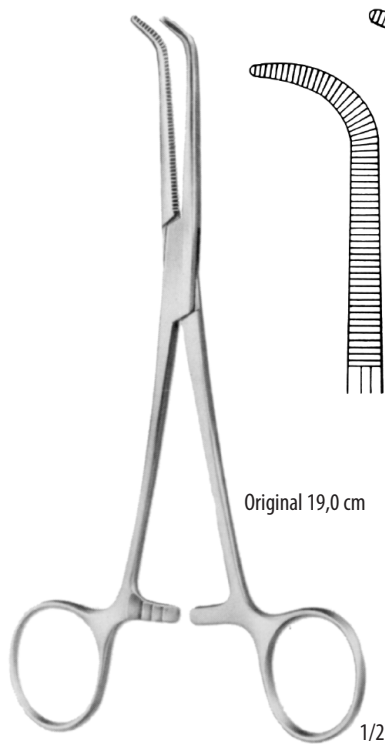

Original 19,0 cm

MIXTER
115 91 0231 – 15,5 cm

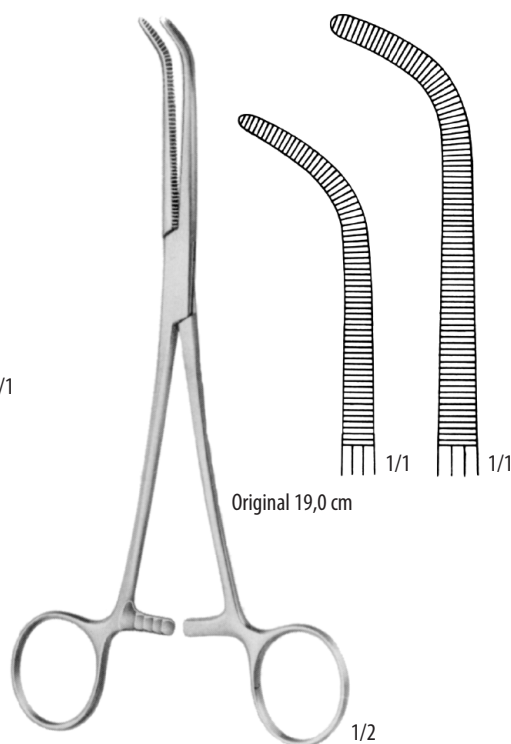
115 91 0232 – 19,0 cm

Original 19,0 cm

MIXTER-O'SHAUGNESSY
115 91 0233 – 15,5 cm

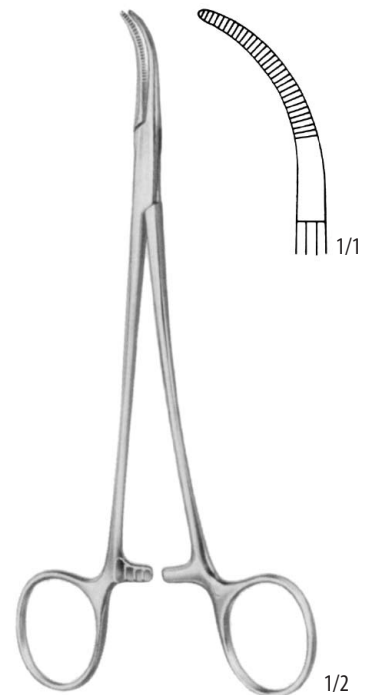
115 91 0234 – 19,0 cm

BABY-MIXTER
115 91 0235

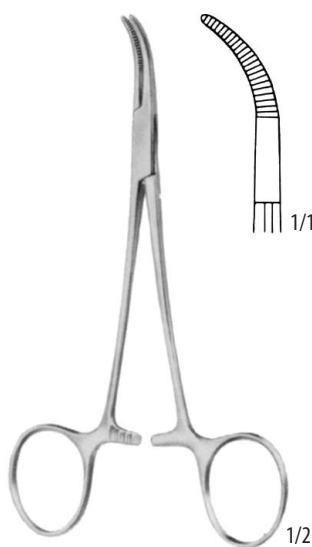
18,0 cm

BABY-MIXTER
115 08 1080

14,0 cm

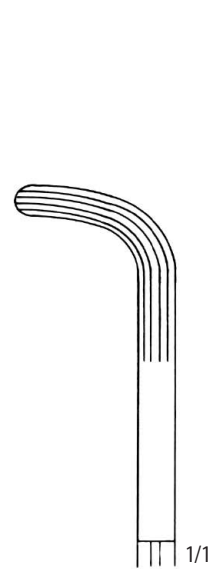

MIXTER
115 91 0238

22,0 cm

115 91 0238

22,0 cm

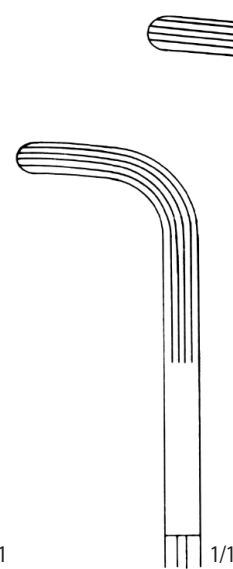
Fig. 1

115 91 0239

25,0 cm

Fig. 2

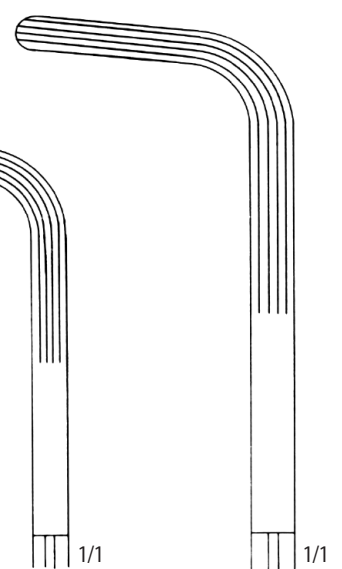
115 91 0240

28,0 cm

Fig. 3

SVORKY PREPARAČNÍ
DISSECTING FORCEPS



Original 20,0 cm

KANTROWITZ

115 91 0245
20,0 cm

115 91 0246
24,0 cm

115 91 0247
28,0 cm



Original 21,0 cm

TOENNIS

115 91 0253 – 21,0 cm – **115 91 0255**
115 91 0254 – 26,0 cm – **115 91 0256**



Original 18,0 cm

GEMINI

115 91 0249
18,0 cm

115 91 0251
25,0 cm

115 91 0252
28,0 cm

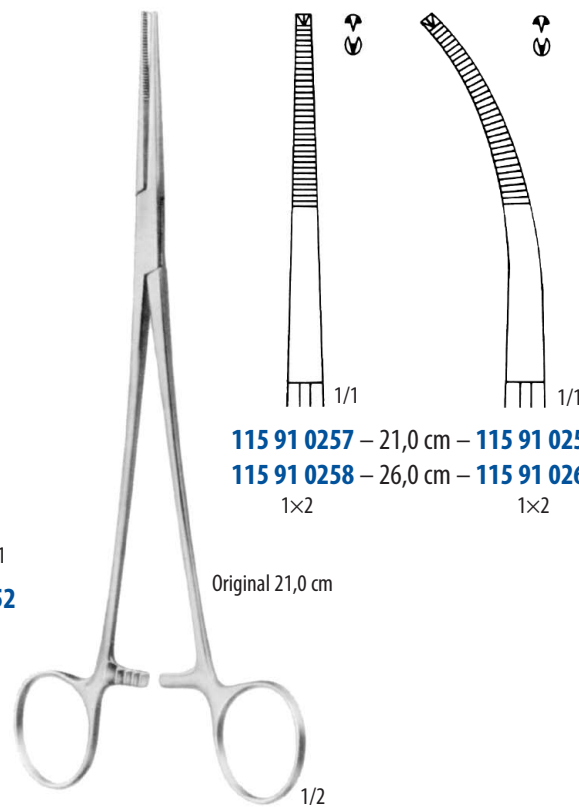

Original 21,0 cm

TOENNIS

115 91 0257 – 21,0 cm – **115 91 0259**
115 91 0258 – 26,0 cm – **115 91 0260**
1x2 1x2

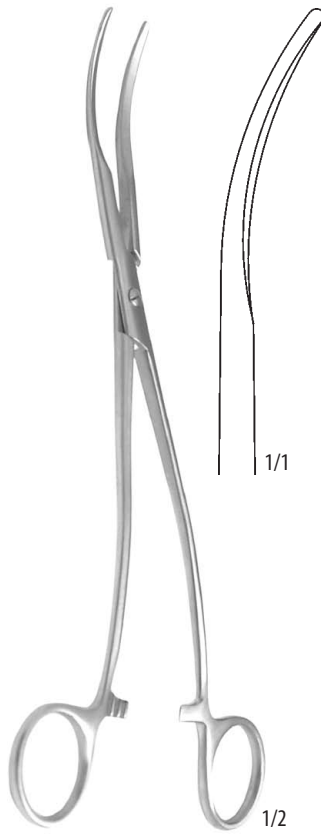

SEMB
115 14 1170
 21,4 cm

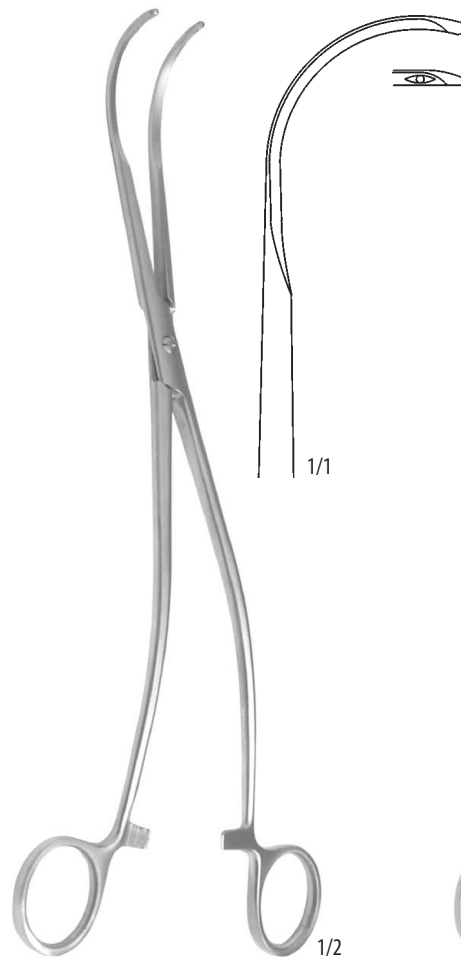

SEMB
115 14 1180
 25,0 cm

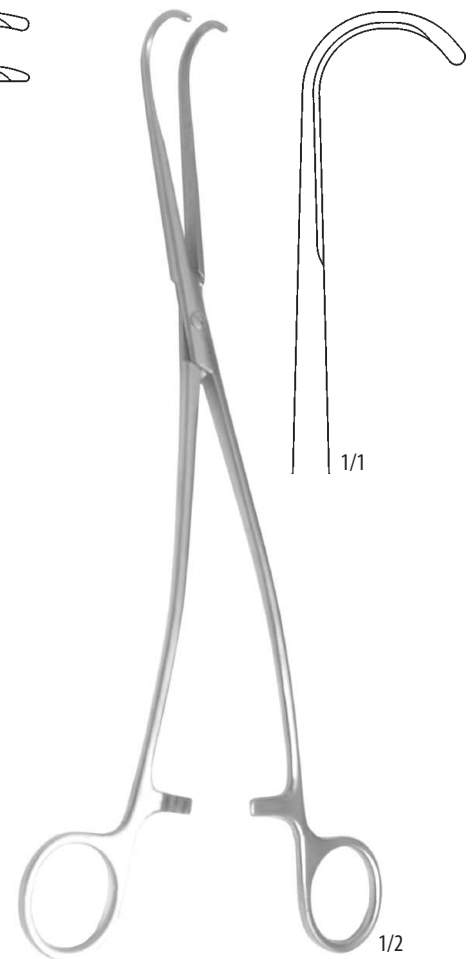

SEMB
115 14 1190
 25,0 cm

SVORKY NA LEDVINY
KIDNEY PEDICLE CLAMPS

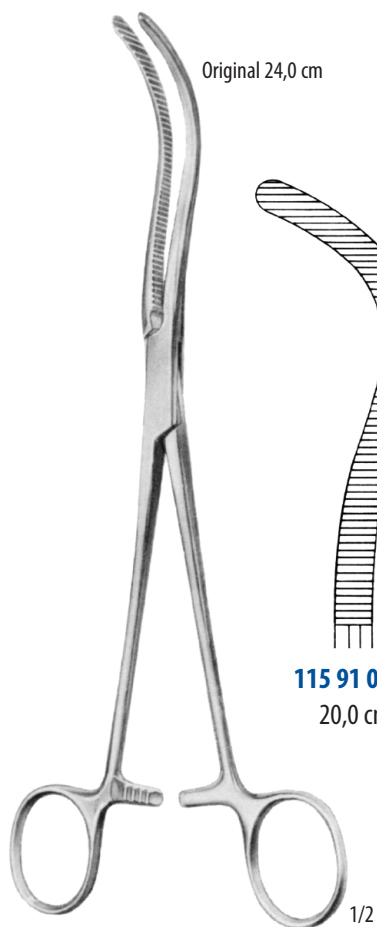

GUYON

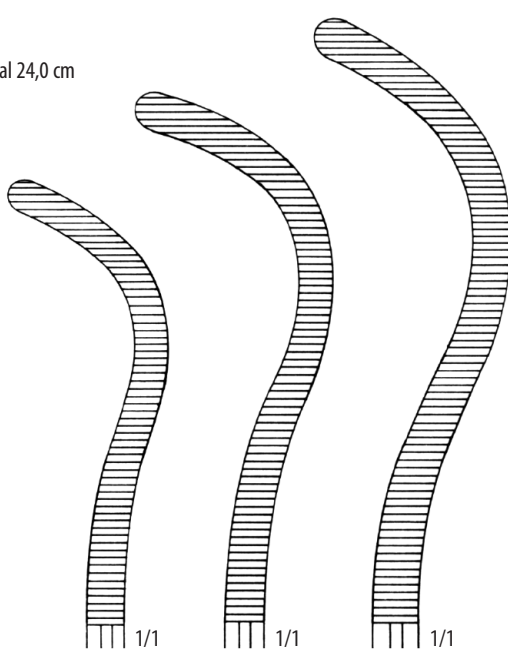

115 91 0265
20,0 cm

115 91 0266
22,0 cm

115 91 0267
24,0 cm



STILLE

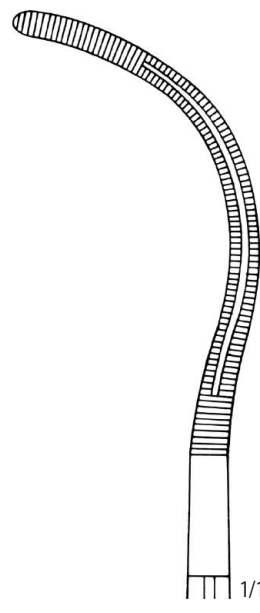

115 91 0268
23,0 cm

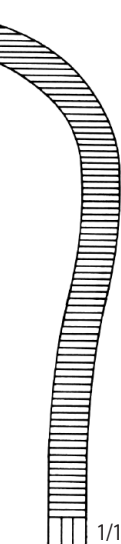

115 91 0269
23,0 cm



115 91 0270
23,0 cm

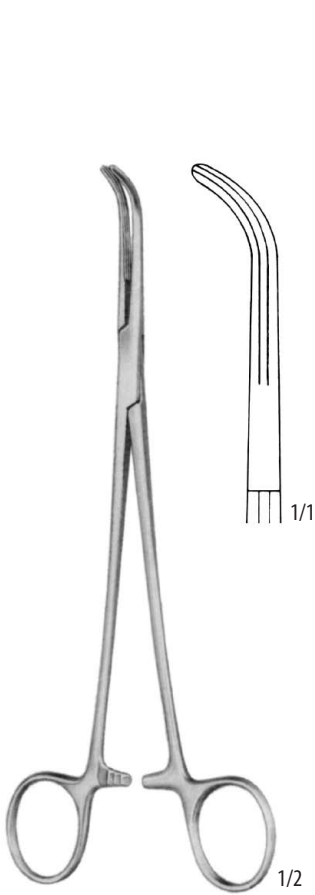

LAHEY
115 91 0261
 19,0 cm

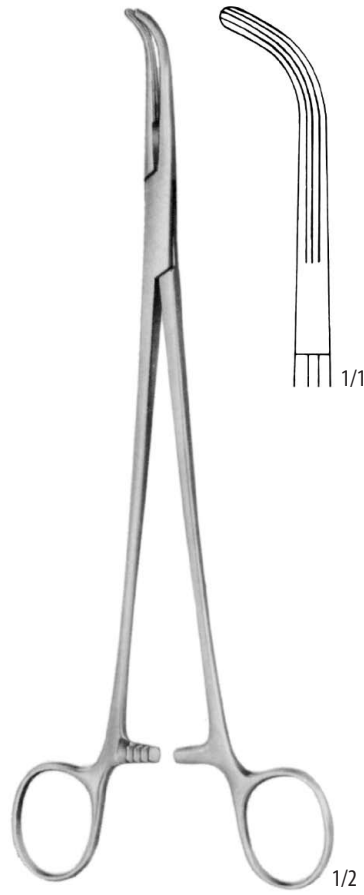

LAHEY
115 91 0262
 23,0 cm



LOWER
115 91 0263
 18,0 cm

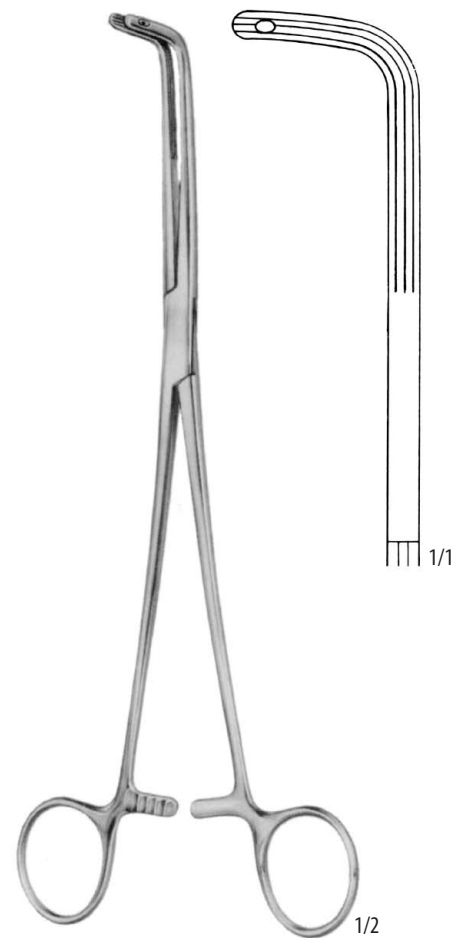

FINOCCHIETTO
115 91 0264
 24,0 cm

SVORKY NA ŽLUČOVOD
GALL DUCT CLAMPS

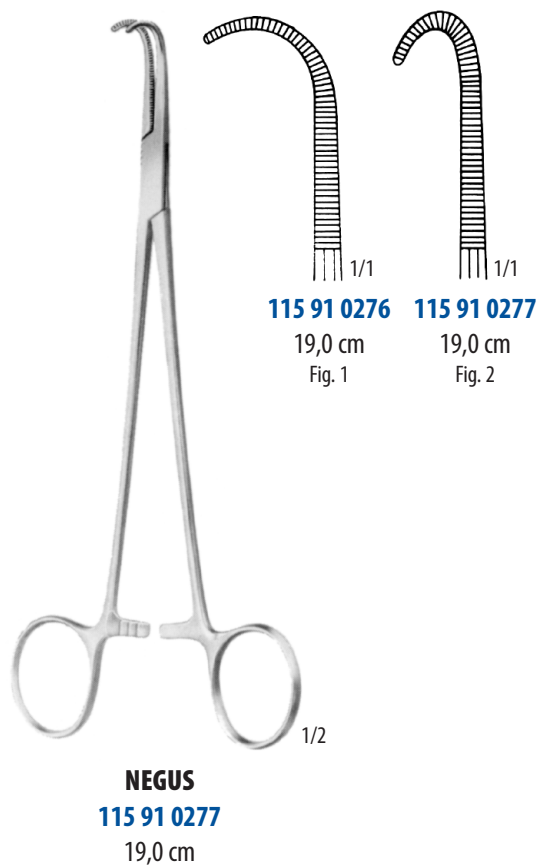
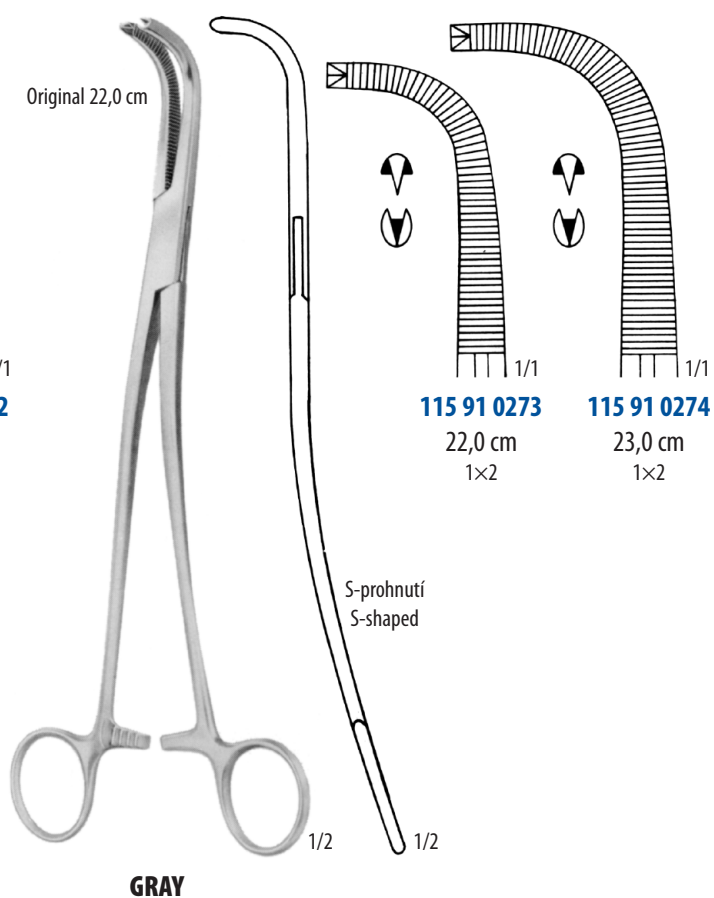
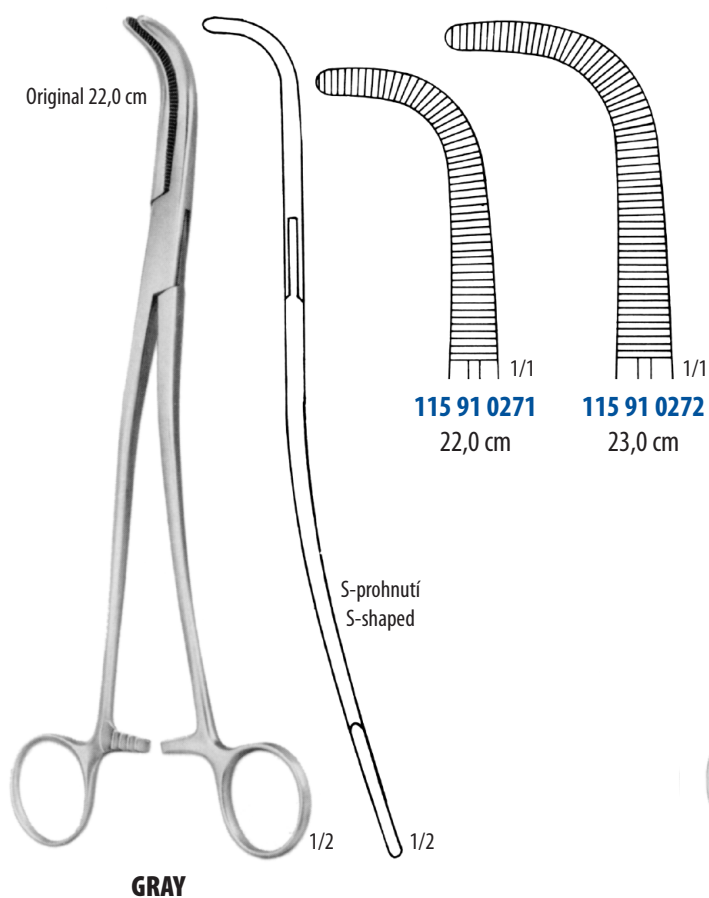

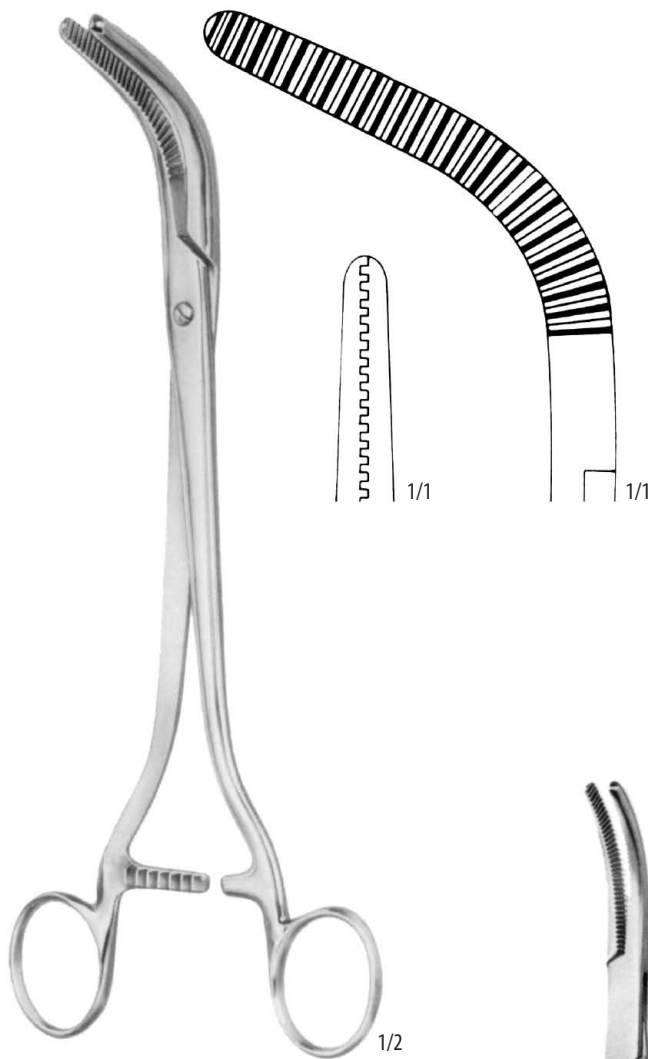

WERTHEIM
115 91 0281
 27,0 cm

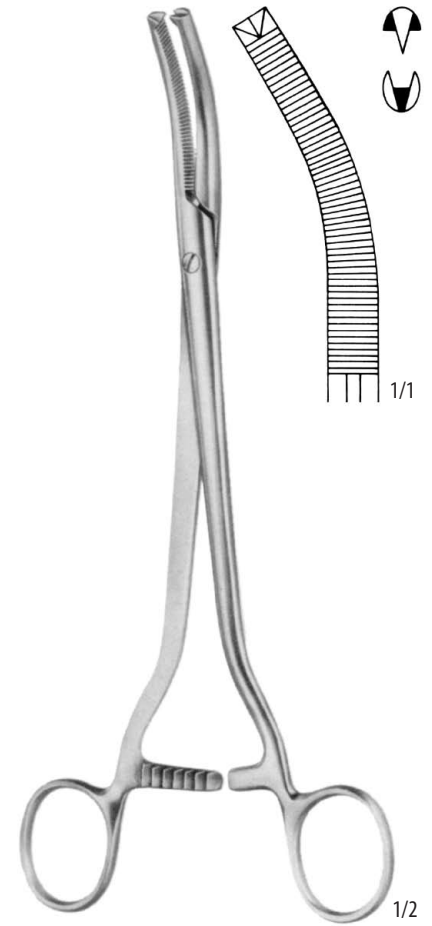

WERTHEIM
115 91 0282
 24,0 cm

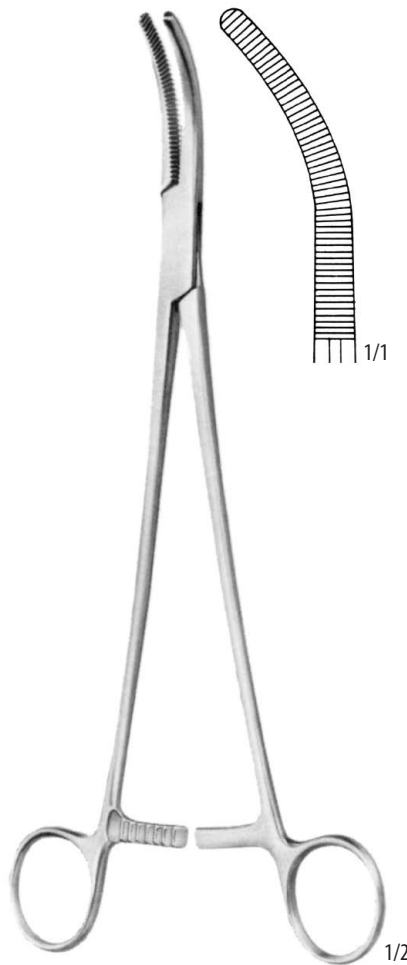

WERTHEIM
115 91 0283
 25,0 cm

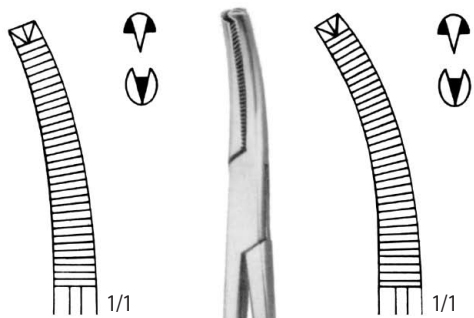
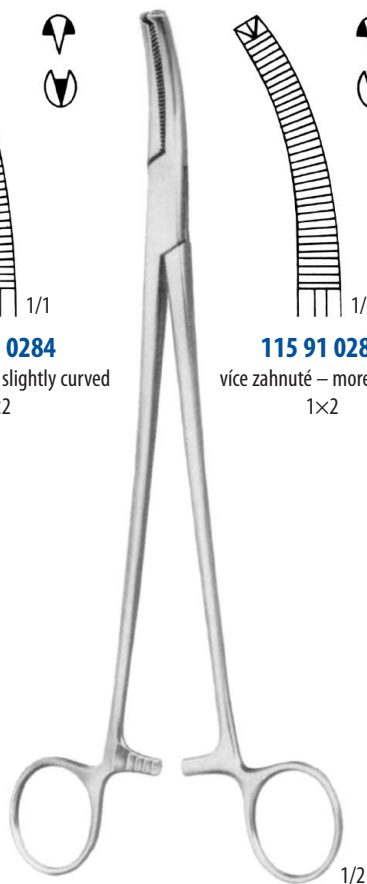
SVORKY NA HYSTEREKTOMII
HYSTERECTOMY CLAMPS, FORCEPS
**115 91 0284**lehce zahnuté – slightly curved
1×2**115 91 0285**více zahnuté – more curved
1×2**WERTHEIM**
23,0 cm

1/2

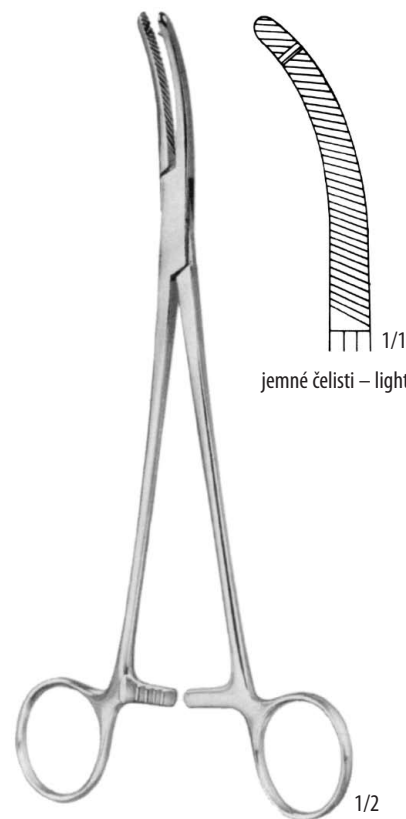
**HEANEY**
115 91 0286
21,0 cm

1/2

jemné čelisti – light jaws

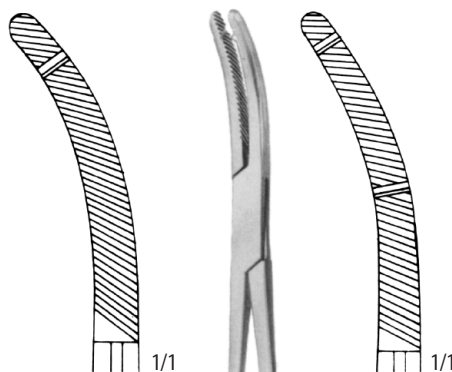

Original 21,0 cm

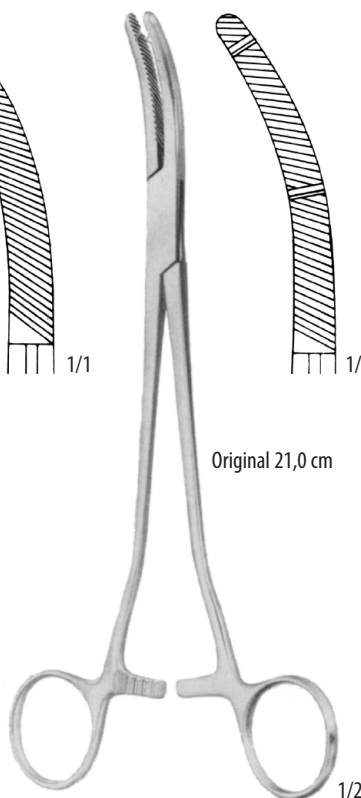
**HEANEY****115 91 0287**
115 91 0288– 21,0 cm –
– 23,0 cm –**115 91 0289**
115 91 0290

1/2

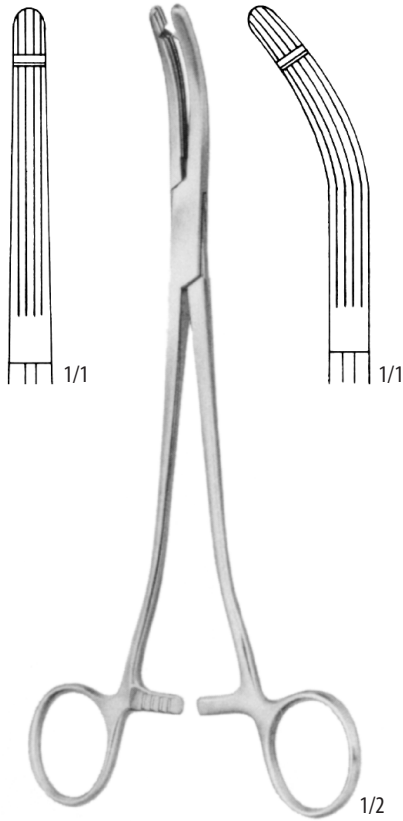

HEANEY-BALANTINE

115 91 0291 – 21,0 cm – 115 91 0292

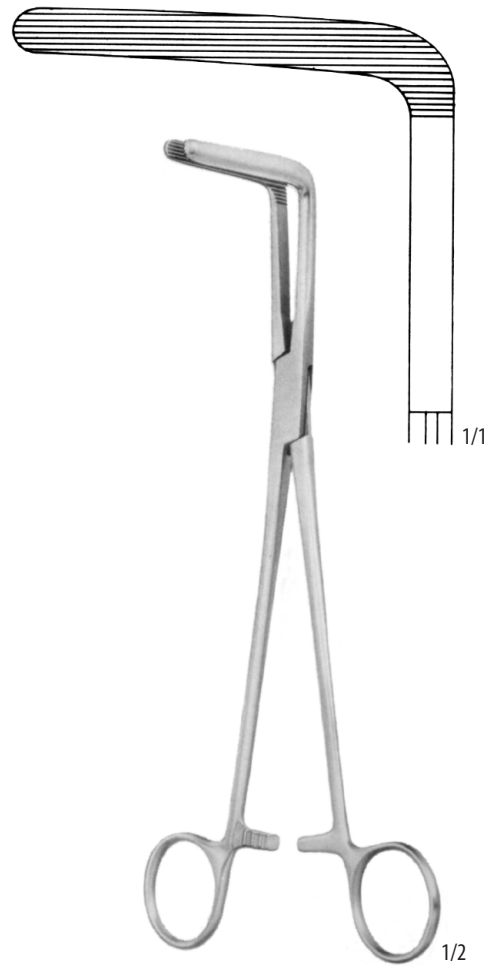

WERTHEIM-CULLEN

115 91 0299
21,5 cm

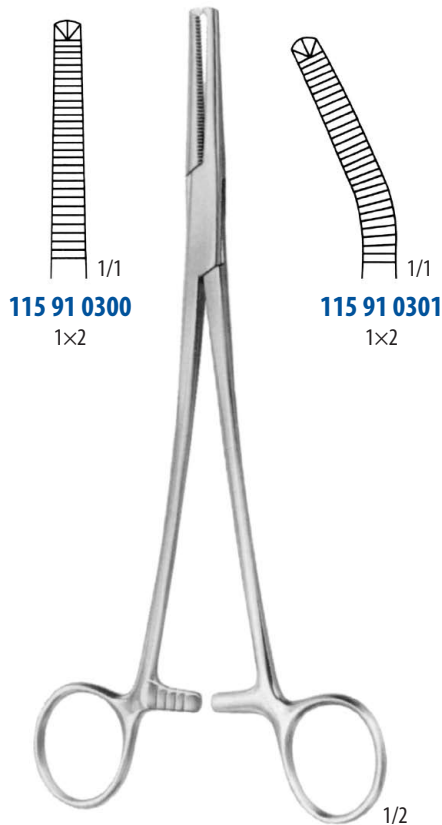

PHANEUF

21,5 cm

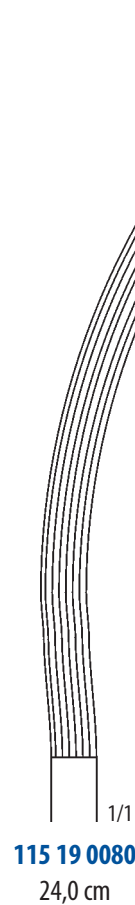
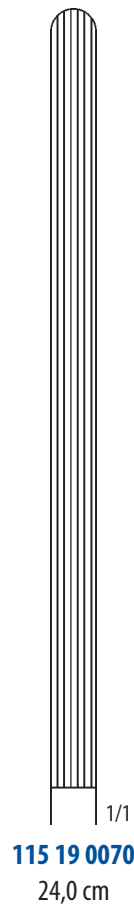
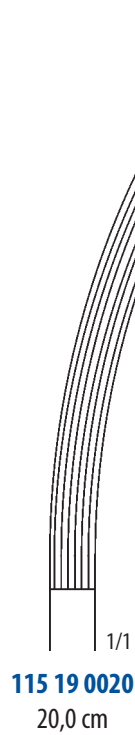
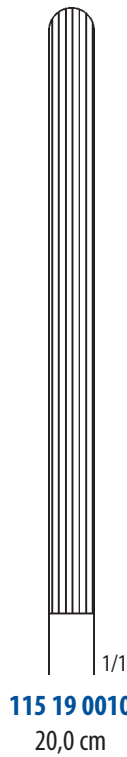
SVORKY NA STŘEVA
INTESTINAL FORCEPS



PARAMETRIUM
 21,0 cm

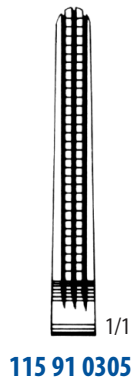

115 91 0305

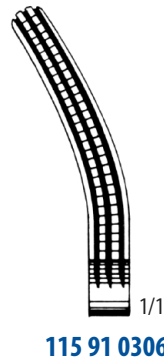

115 91 0306

Fig. 1

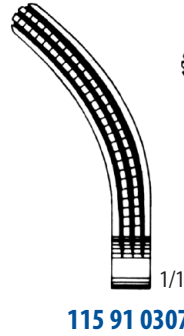

115 91 0307

Fig. 2

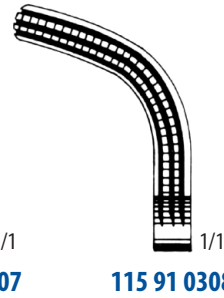

115 91 0308

Fig. 3



PARAMETRIUM
 24,0 cm

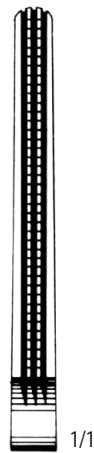

115 91 0309

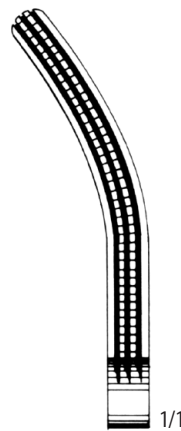

115 91 0310

Fig. 1

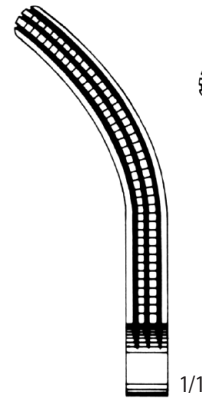

115 91 0311

Fig. 2

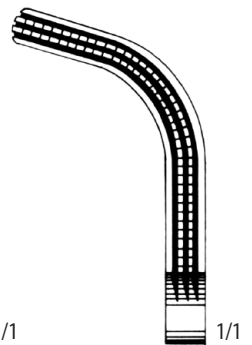

115 91 0312

Fig. 3

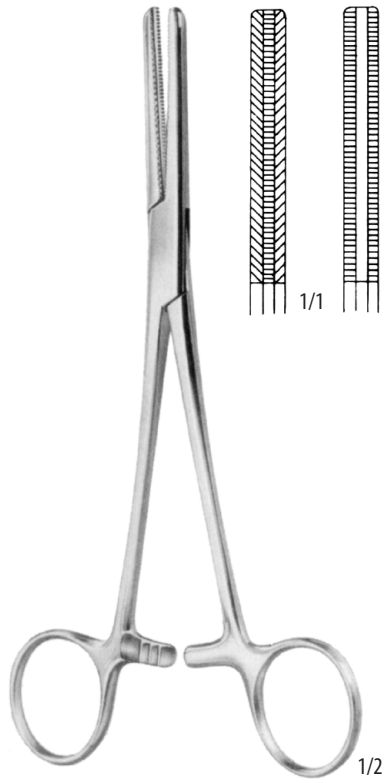

1/2

FERGUSSON**115 91 0313**

– 16,0 cm –

115 91 0314

– 20,0 cm –

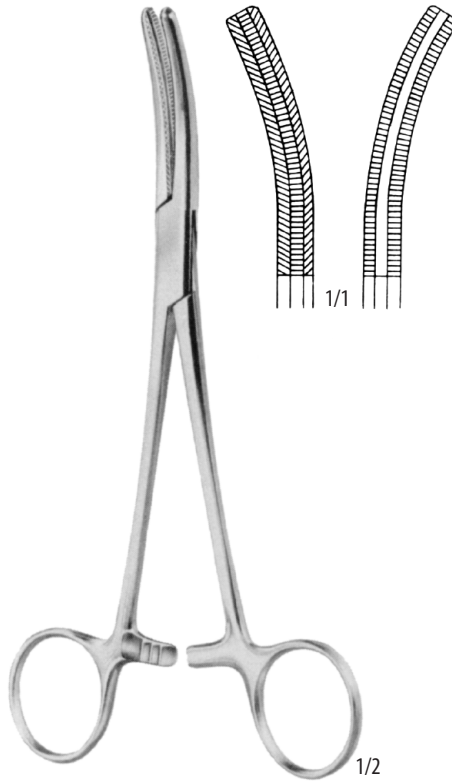

1/2

115 91 0315**115 91 0316**

1/2

PRATT**115 91 0317**

15,0 cm

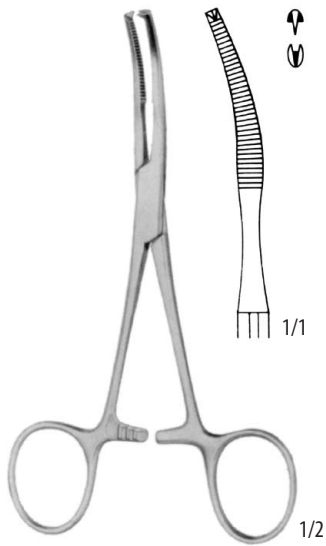

BABY-MIKULICZ
115 91 0322
 14,0 cm

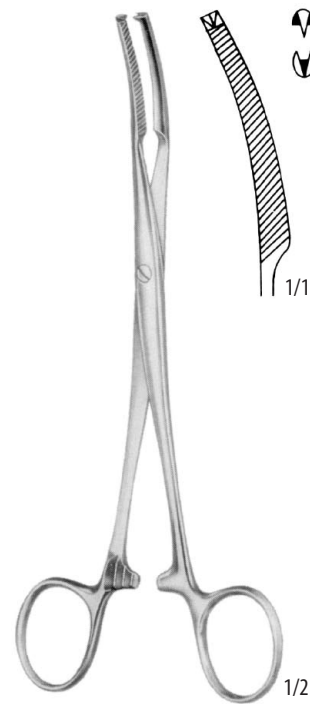

MIKULICZ
115 27 0070
 18,0 cm

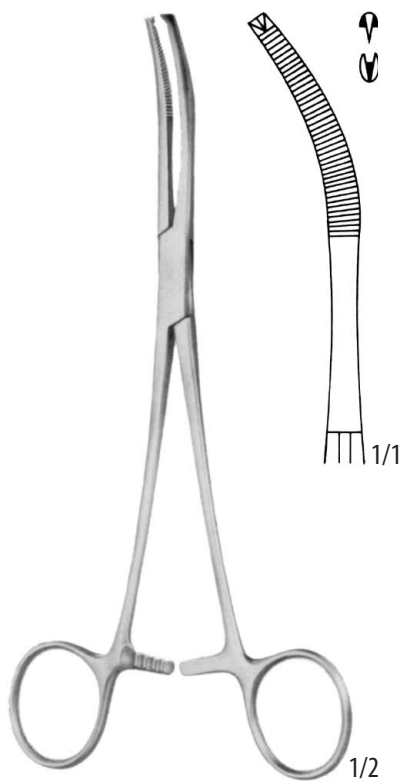

MIKULICZ
115 91 0326
 20,0 cm

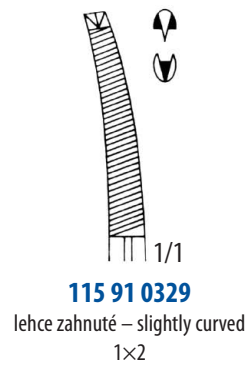

115 91 0329
 lehce zahnuté – slightly curved
 1×2

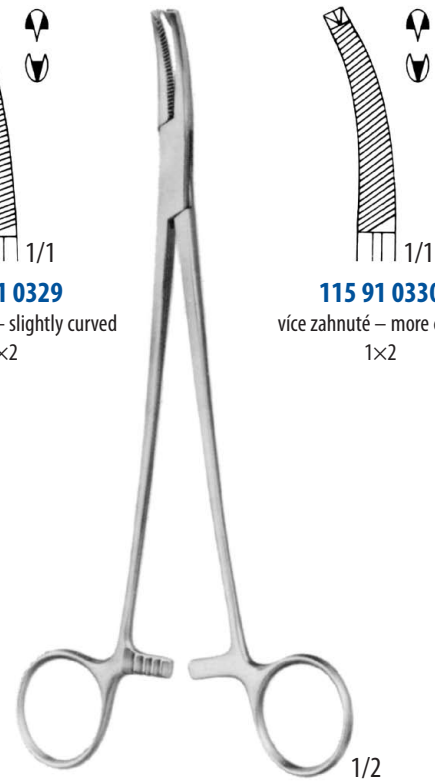

FAURE
 20,0 cm

115 91 0330
 více zahnuté – more curved
 1×2



1/2

SCHAEDEL
115 91 0332
9,0 cm



Original 9,0 cm

1/2

JONES
115 91 0333 – 5,0 cm
115 91 0334 – 9,0 cm



1/2

ENGL. MODELL
115 91 0335
9,0 cm



1/1

1/2

DOYEN
115 91 0336
18,0 cm



1/2

BERNHARD
115 91 0337
16,5 cm



1/2

Original 18,0 cm

LANE
115 91 0338 – 15,0 cm
115 91 0339 – 18,0 cm
115 91 0340 – 20,0 cm



1/2

BACKHAUS
115 08 0780
11,8 cm



1/2

BACKHAUS
115 08 0790
12,0 cm



BACKHAUS-CLIP
115 91 0341
11,0 cm



Original 15,0 cm
115 91 0343 – 11,0 cm
115 91 0345 – 15,0 cm



Original 13,0 cm
115 08 0810 – 8,0 cm
115 08 0820 – 13,0 cm



Original 13,0 cm
115 91 0348 – 13,0 cm
115 91 0349 – 15,0 cm

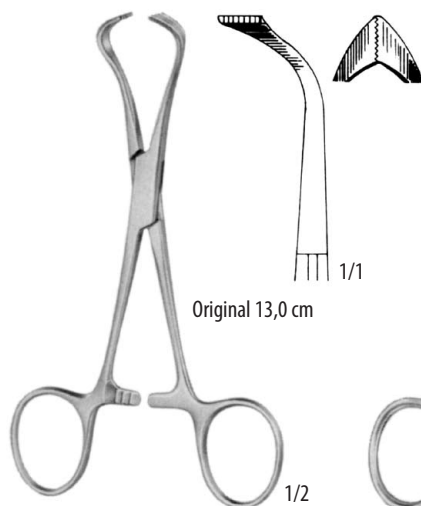

Original 13,0 cm
115 91 0350 – 10,0 cm
115 91 0351 – 13,0 cm

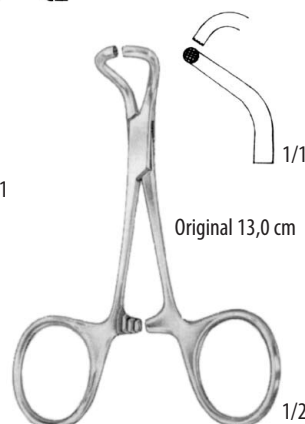

Original 13,0 cm
115 91 0352 – 10,0 cm
115 91 0353 – 13,0 cm

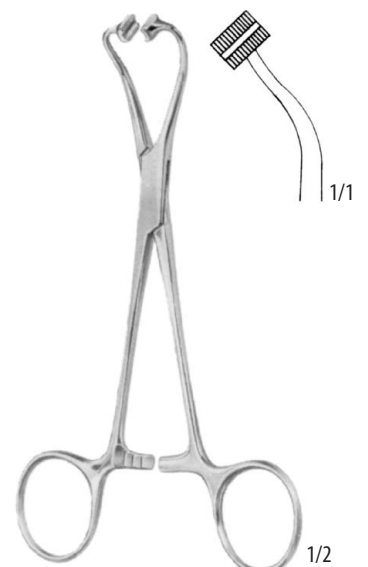

115 91 0354
14,5 cm

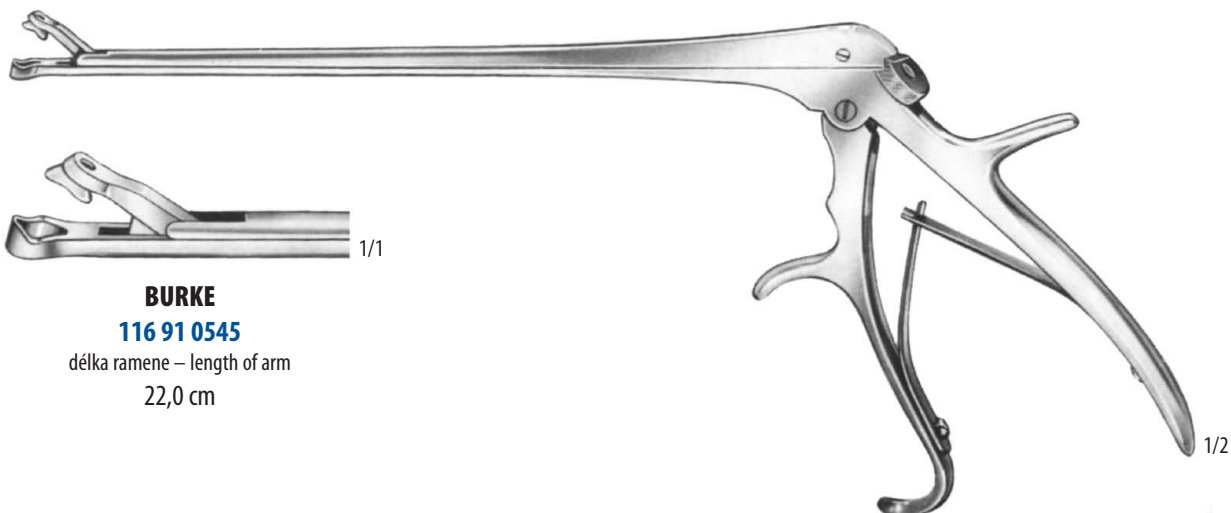
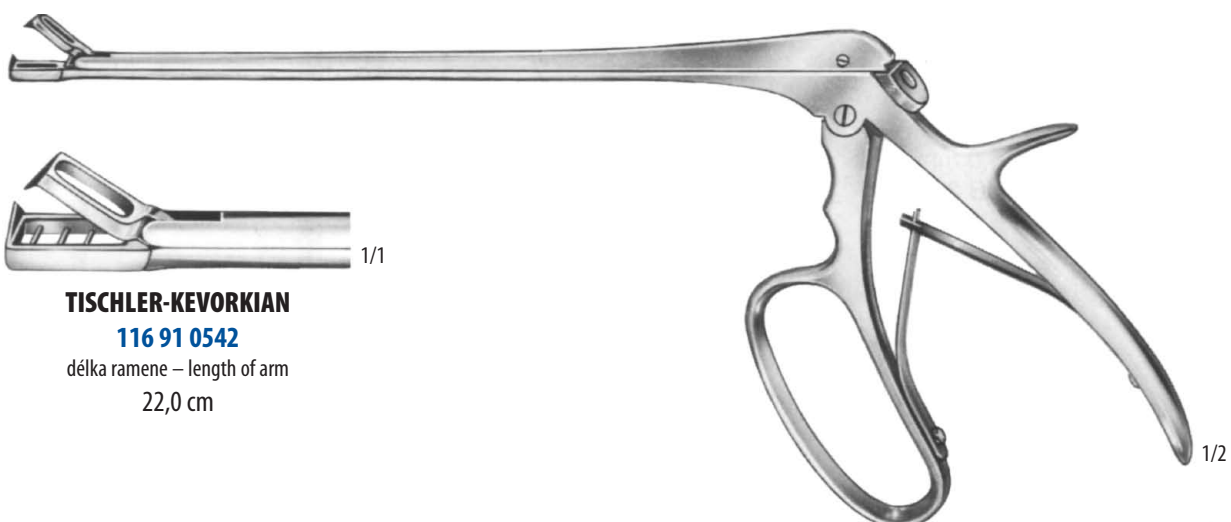
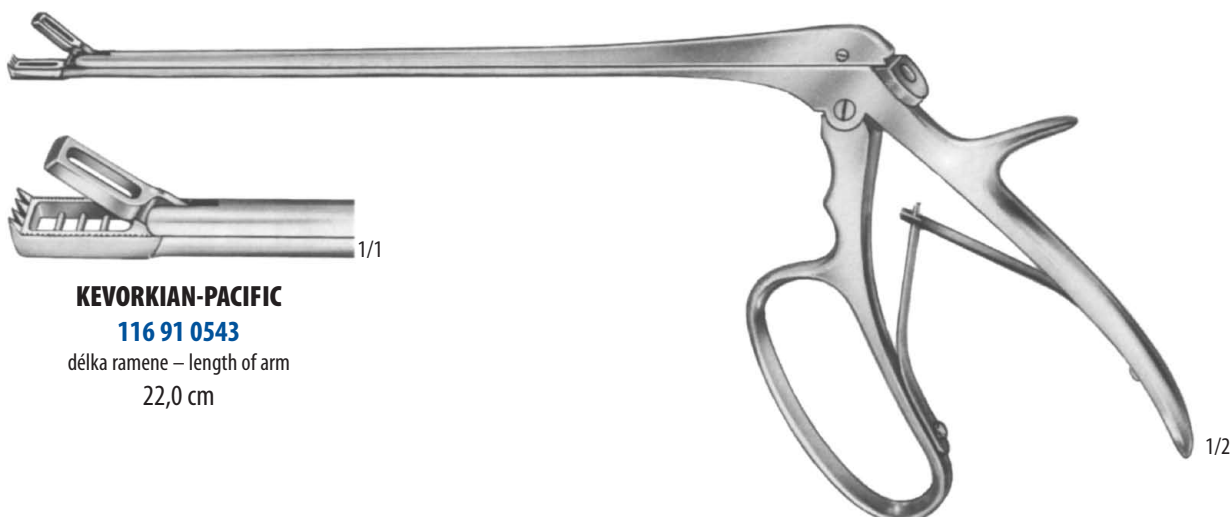
KLEŠTĚ NA BIOPSII
CERVICAL BIOPSY FORCEPS
**BURKE****116 91 0545**
 délka ramene – length of arm
 22,0 cm
**TISCHLER-KEVORKIAN****116 91 0542**
 délka ramene – length of arm
 22,0 cm
**KEVORKIAN-PACIFIC****116 91 0543**
 délka ramene – length of arm
 22,0 cm

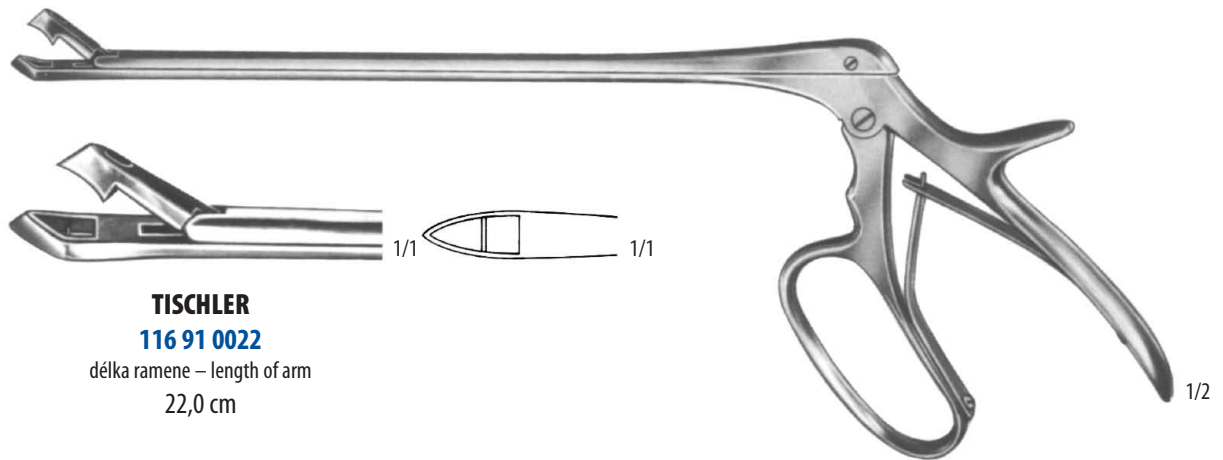

TISCHLER
116 91 0022

délka ramene – length of arm
22,0 cm

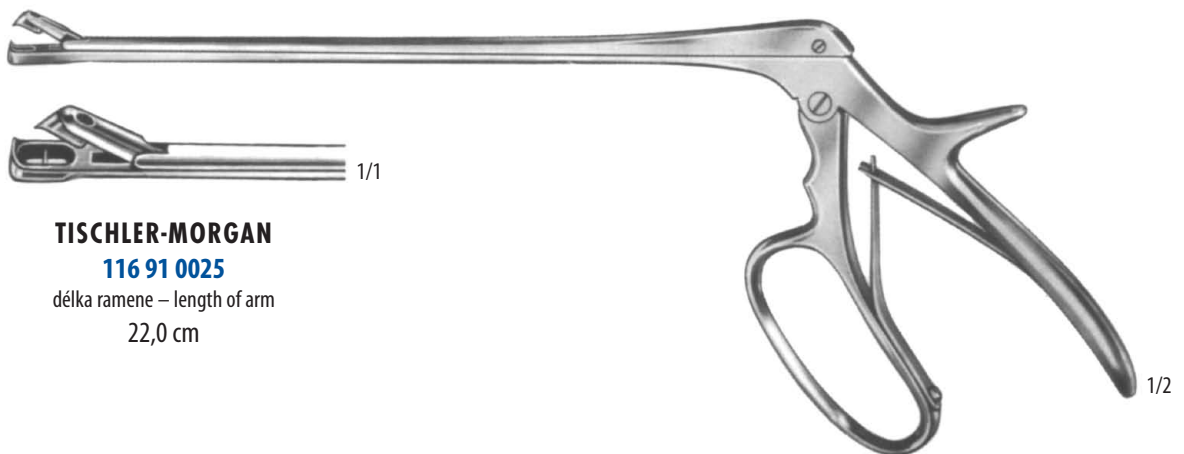

TISCHLER-MORGAN
116 91 0025

délka ramene – length of arm
22,0 cm

KLEŠTĚ NA BIOPSII DĚTSKÉ
CERVICAL BIOPSY FORCEPS FOR CHILDREN

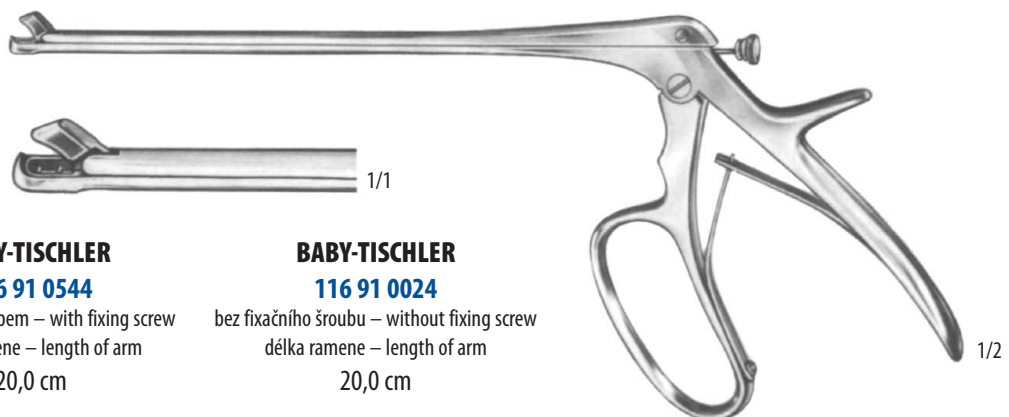

BABY-TISCHLER
116 91 0544

s fixačním šroubem – with fixing screw
délka ramene – length of arm
20,0 cm

BABY-TISCHLER
116 91 0024

bez fixačního šroubu – without fixing screw
délka ramene – length of arm
20,0 cm



GELLHORN
116 91 0026
23,0 cm



FAURE
116 91 0027
23,0 cm



SCHUBERT
116 91 0028 – 21,0 cm
116 91 0029 – 29,0 cm

Original 21,0 cm



THOMS-GAYLOR

116 91 0030

24,0 cm



SCHUBERT

116 91 0031

26,0 cm



TISCHLER

116 91 0032

27,0 cm

 1/1
5 mm
Fig. 1

 1/1
7 mm
Fig. 2

SCHUMACHER-VAN DOREN
116 91 0033 – 24,0 cm – 116 91 0034
Fig. 1 Fig. 2

 1/1

VAN DOREN
116 91 0035
25,0 cm

 1/1

VAN DOREN
116 91 0036
25,0 cm

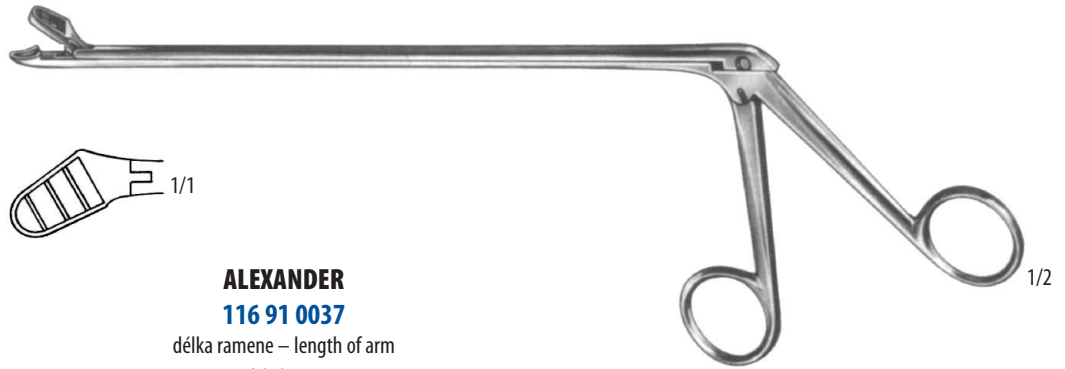

ALEXANDER
116 91 0037
délka ramene – length of arm
20,0 cm



KEVORKIAN
116 91 0038
délka ramene – length of arm
23,0 cm

KEVORKIAN
116 91 0039
délka ramene – length of arm
25,0 cm

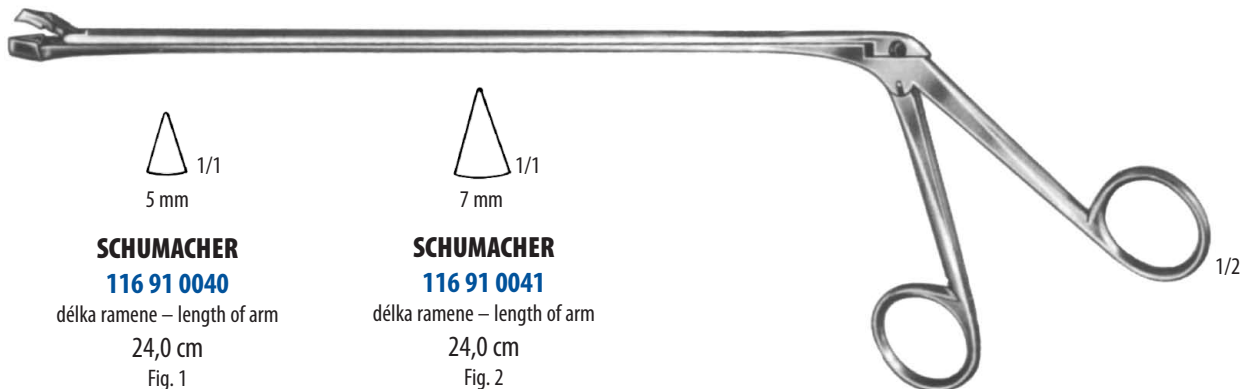

SCHUMACHER
116 91 0040
délka ramene – length of arm
24,0 cm
Fig. 1

SCHUMACHER
116 91 0041
délka ramene – length of arm
24,0 cm
Fig. 2

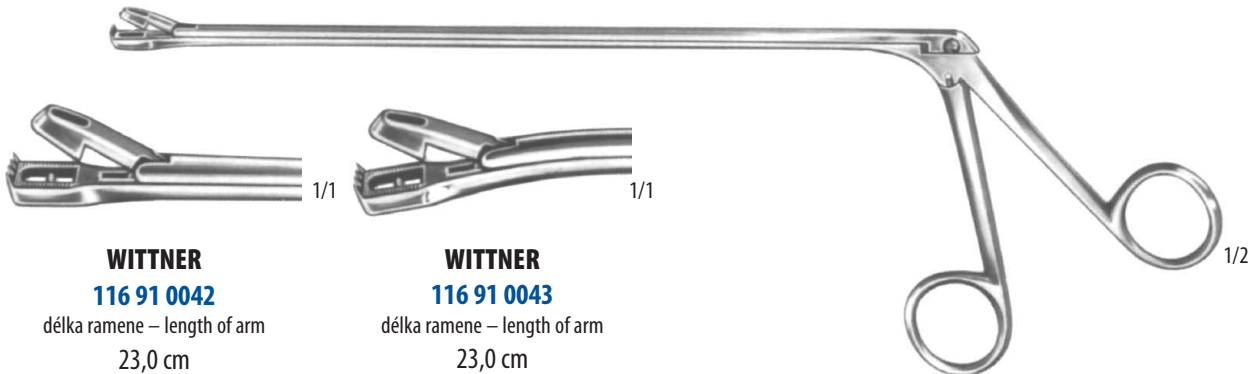
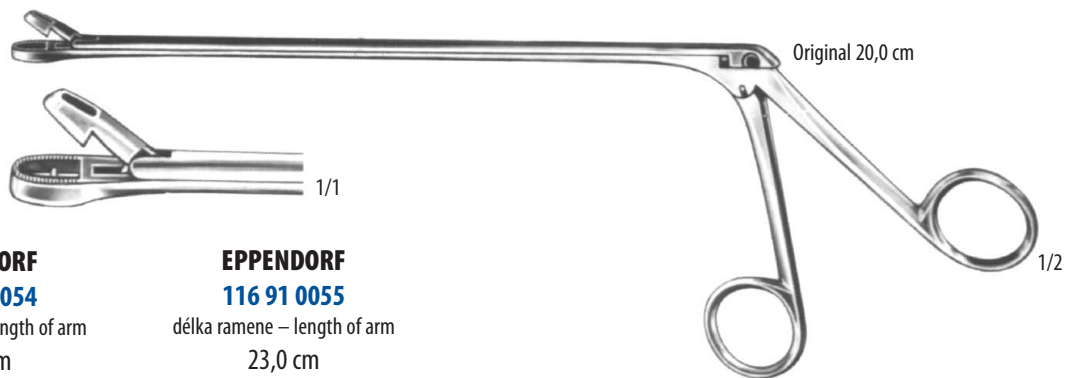
KLEŠTĚ NA BIOPSII
CERVICAL BIOPSY FORCEPS
**WITTNER****116 91 0042**
 délka ramene – length of arm
 23,0 cm
WITTNER**116 91 0043**
 délka ramene – length of arm
 23,0 cm
**EPPENDORF****116 91 0054**
 délka ramene – length of arm
 20,0 cm
EPPENDORF**116 91 0055**
 délka ramene – length of arm
 23,0 cm
**BERGER****116 91 0546**
 délka ramene – length of arm
 20,5 cm

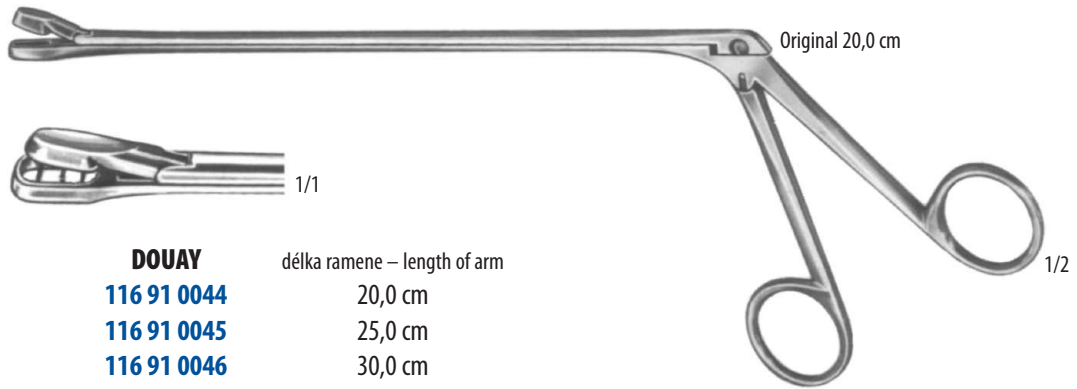

DOUAY	délka ramene – length of arm
116 91 0044	20,0 cm
116 91 0045	25,0 cm
116 91 0046	30,0 cm
116 91 0047	35,0 cm
116 91 0048	40,0 cm



1/2



1/1

TISCHLER**116 91 0050**délka ramene – length of arm
25,0 cm

1/2



1/1

KEVORKIAN**116 91 0051**délka ramene – length of arm
25,0 cm

1/2



1/1

EPPENDORF**116 91 0052**délka ramene – length of arm
25,0 cm

1/2



1/1

MINI-TOWNSEND**116 91 0053**délka ramene – length of arm
25,0 cm

1/2

TISCHLER

držadlo – handle

116 91 0049

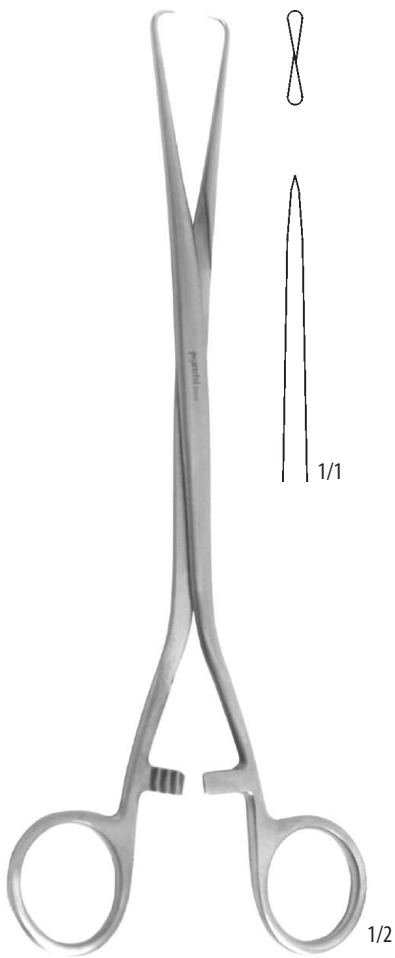

SCHRÖDER
117 27 0010
25,0 cm

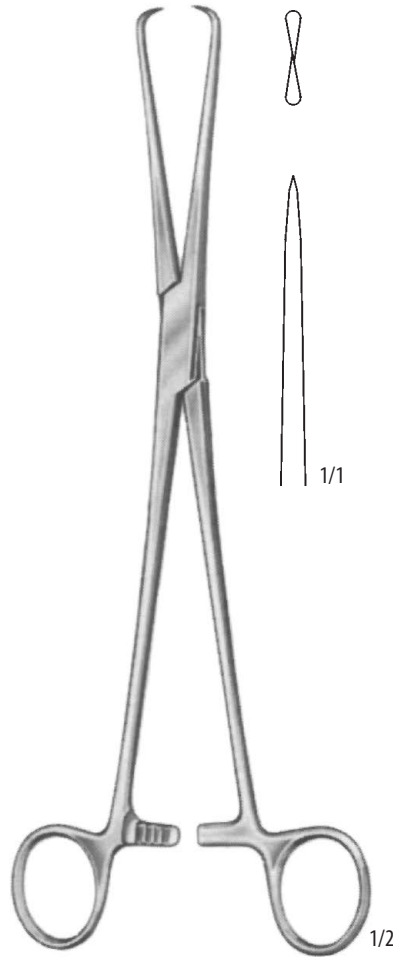

POZZI
117 91 0201
25,0 cm

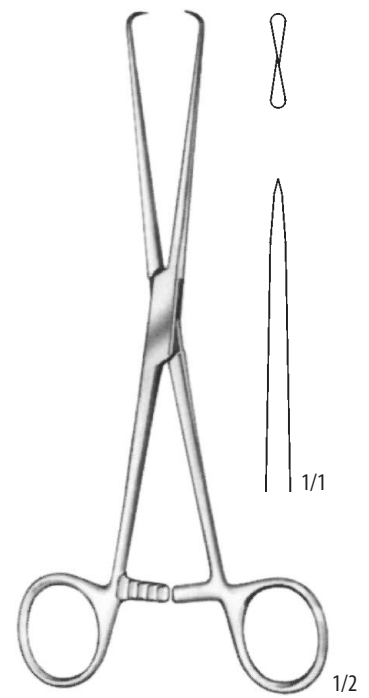

BARRETT
117 91 0202
18,0 cm

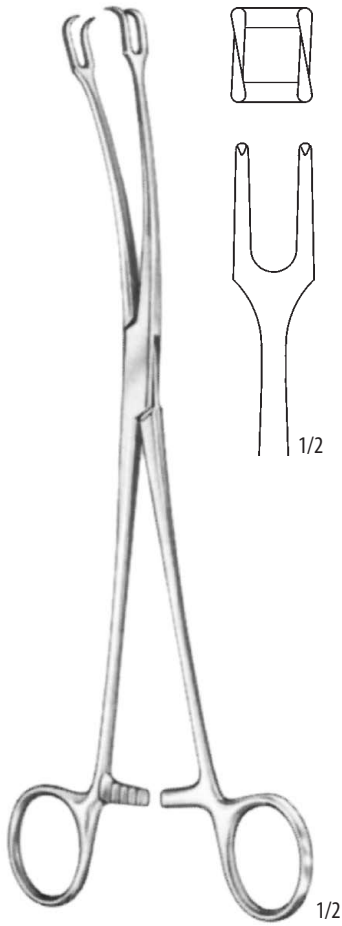

SCHRÖDER
117 91 0210
24,0 cm

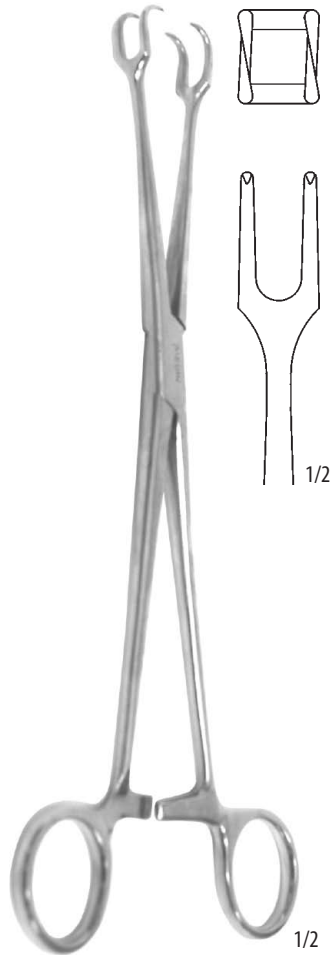

SCHRÖDER
117 27 0020
25,0 cm

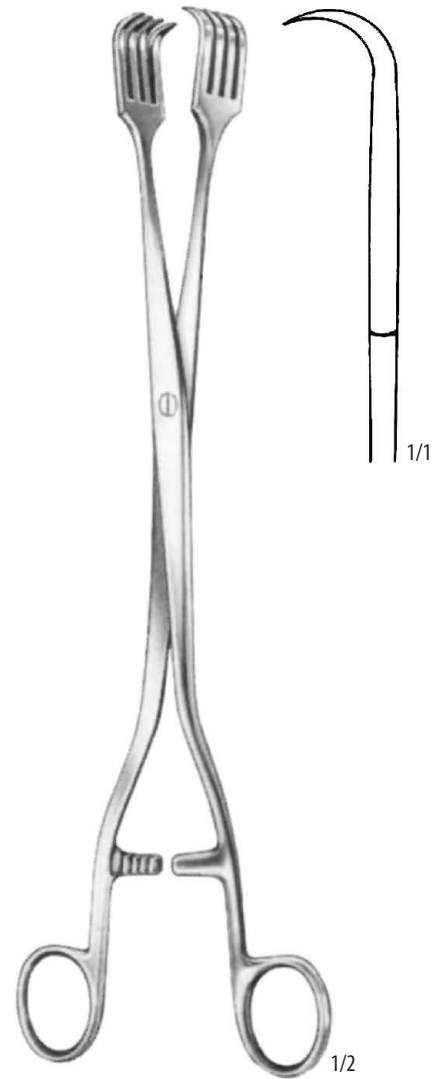

PRATT
117 91 0211
28,0 cm



117 27 0150
25,3 cm

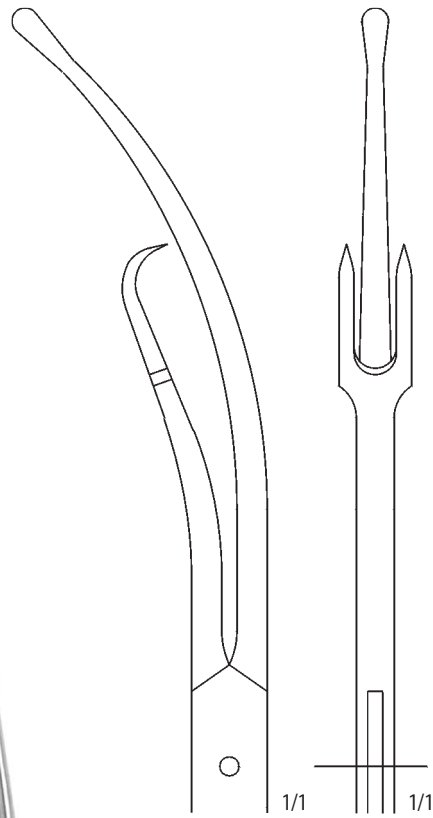

SAIRGES
117 91 0203
23,0 cm



MUSEUX
117 27 0050
25,0 cm

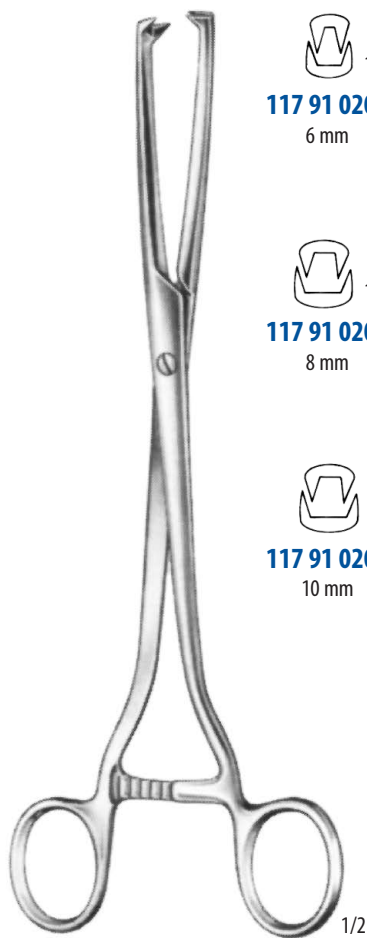

117 91 0204
6 mm

117 91 0205
8 mm

117 91 0206
10 mm

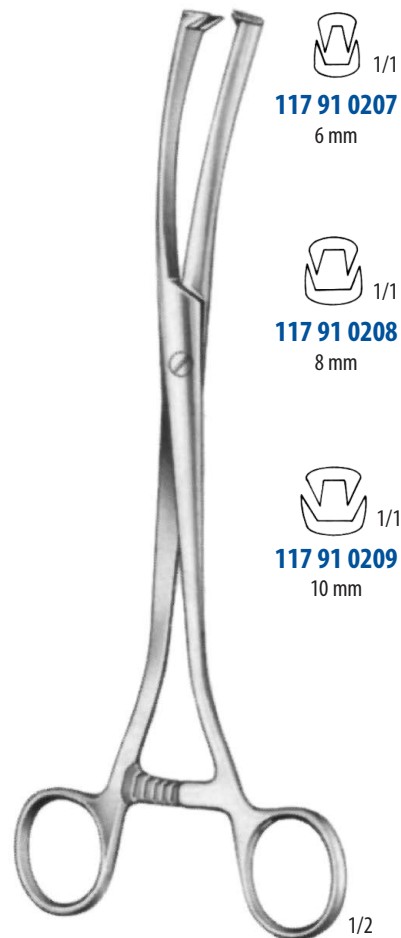

117 91 0207
6 mm

117 91 0208
8 mm

117 91 0209
10 mm

MUSEUX
rovné – straight
24,0 cm

MUSEUX
zahnuté – curved
24,0 cm



JACOBS
117 91 0212
21,0 cm



JACOBS
117 91 0213
21,0 cm



TEALE
117 91 0214
23,0 cm



DARTIGUES
117 91 0077
27,0 cm



SOMER
117 91 0078
zahnuté – curved
23,0 cm

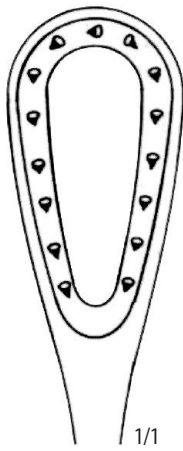

1/1

117 91 0168
rovné – straight

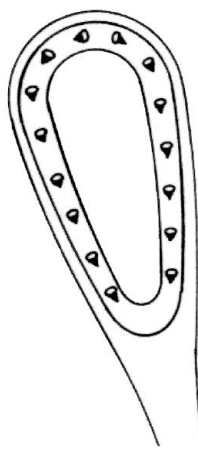

1/1

117 91 0169
zahnuté – curved

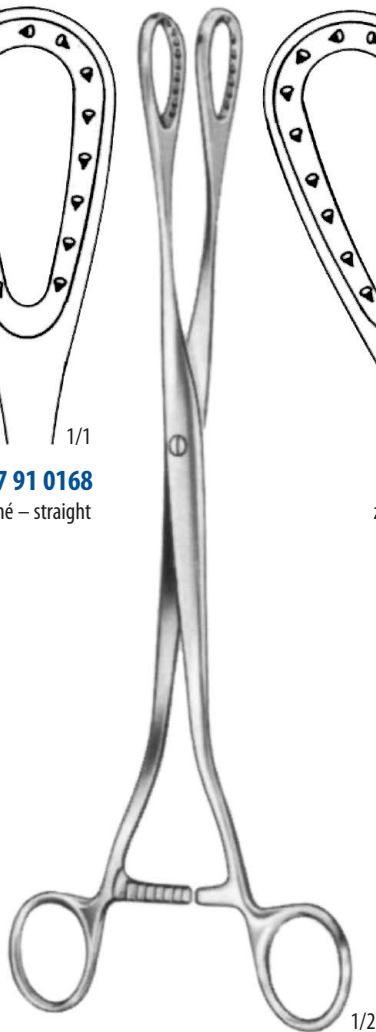

1/2

SAENGER
117 91 0168
27,0 cm



1/1

IOWA
117 91 0175
26,0 cm

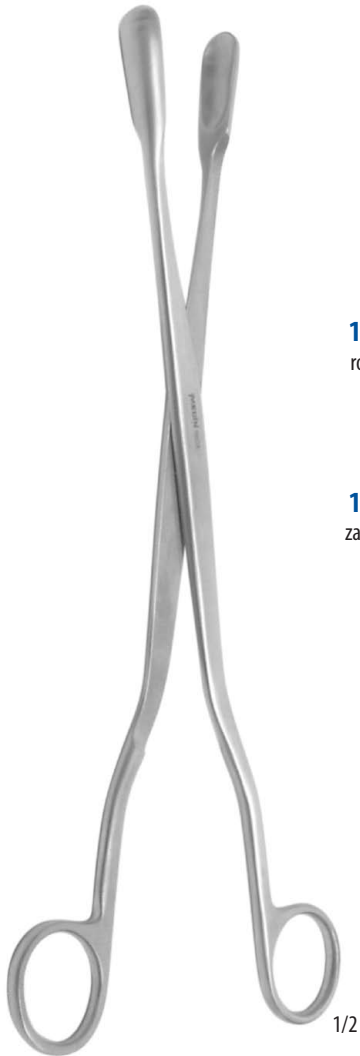

WINTER
28,0 cm



117 91 0165
rovné – straight
28,0 cm
Fig. 1



117 91 0166
rovné – straight
28,0 cm
Fig. 2



117 28 0010
rovné – straight
28,0 cm

117 91 0167
zahnuté – curved
28,0 cm
Fig. 1

117 91 0176
zahnuté – curved
28,0 cm
Fig. 2

117 28 0020
zahnuté – curved
28,0 cm



WINTER
28,0 cm



Original 40,0 cm

1/4

NAEGELE

117 91 0154

36,0 cm

117 91 0155

40,0 cm

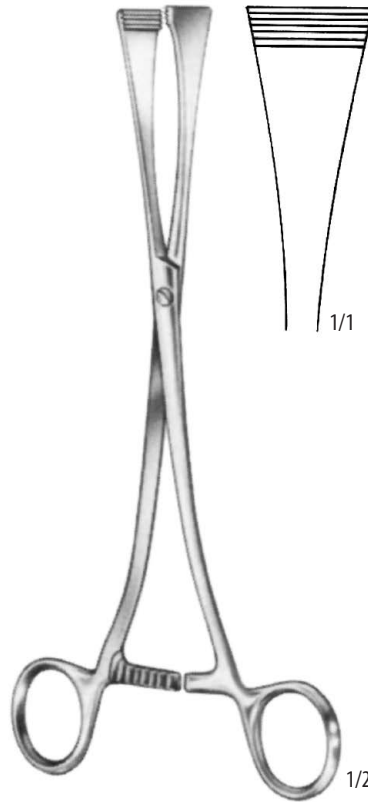

1/1

1/2

GREEN-ARMYTAGE

117 91 0170

21,0 cm



1/4

WRIGLEY

117 91 0162

28,0 cm



1/4

DE LEE

117 91 0163

30,0 cm



1/4

PIPER

117 91 0164

44,0 cm



1/4

McLEAN
117 91 0159
36,0 cm



1/4

KIELLAND
117 91 0160
41,0 cm



1/4

KIELLAND-LUIKART
117 91 0161
40,0 cm



1/4

SIMPSON
117 91 0156
23,0 cm



1/4

SIMPSON
117 91 0157
30,0 cm

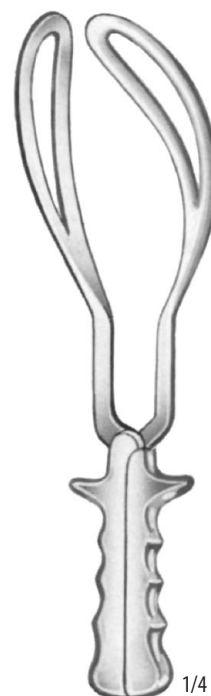

1/4

SIMPSON-BRAUN
117 91 0158
36,0 cm

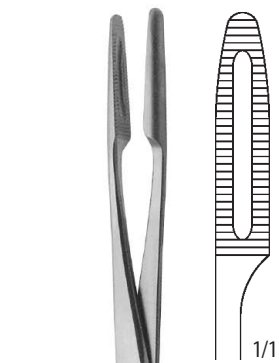

1/1



1/2

GROSS-MAIER
117 27 0260
26,0 cm

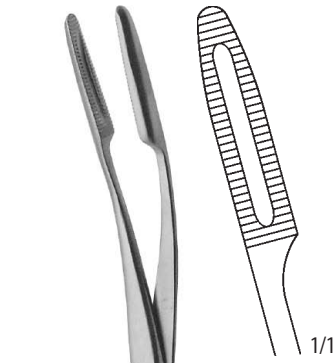

1/1



1/2

GROSS-MAIER
117 27 0280
25,7 cm

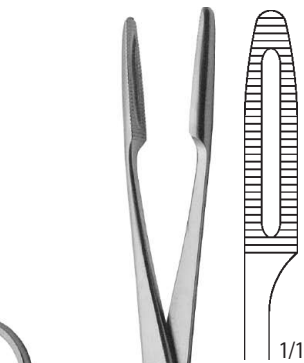

1/1



1/2

117 27 0270
26,0 cm

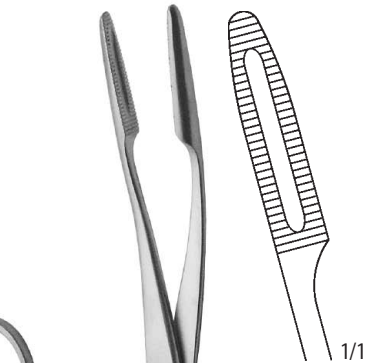

1/1



1/2

117 27 0290
25,7 cm



117 27 0500
25,0 cm

117 27 0510
25,0 cm

BOZEMANN
117 27 0510
25,0 cm



117 91 0153
délka ramene – length of arm
20,0 cm
průměr – diameter
3,0 mm

1/2

PERFORÁTORY
PERFORATORS



1/2

NAEGELE
117 91 0171
25,0 cm



1/2

SPELLIE
117 91 0172
25,0 cm



TARNIER
BASIOTRIBE
BASIOTRIBE
117 91 0173
46,0 cm



BRAUN
CRANIOCLAST
CRANIOCLAST
117 91 0174
42,0 cm



VOLKMANN



1/2
118 08 0350
21,5 cm



1/2
118 08 0390
22,4 cm



1/2
118 08 0410
22,0 cm

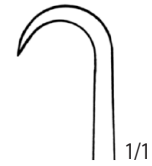

1/1

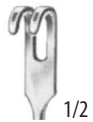

1/2
118 08 0360
21,5 cm



1/2
118 08 0400
22,4 cm



1/2
118 08 0420
22,0 cm



1/1

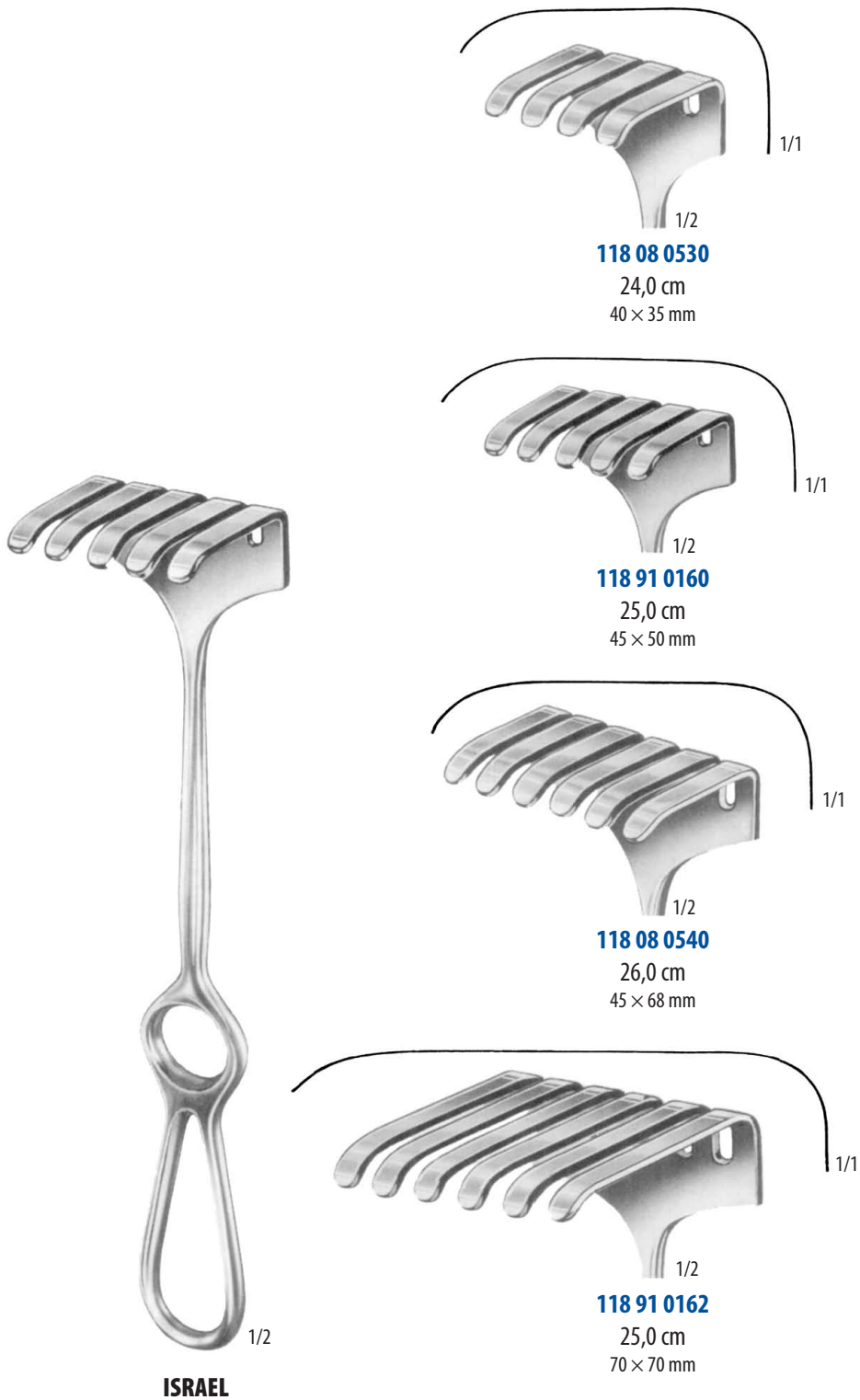



LANGENBECK
21,0 cm

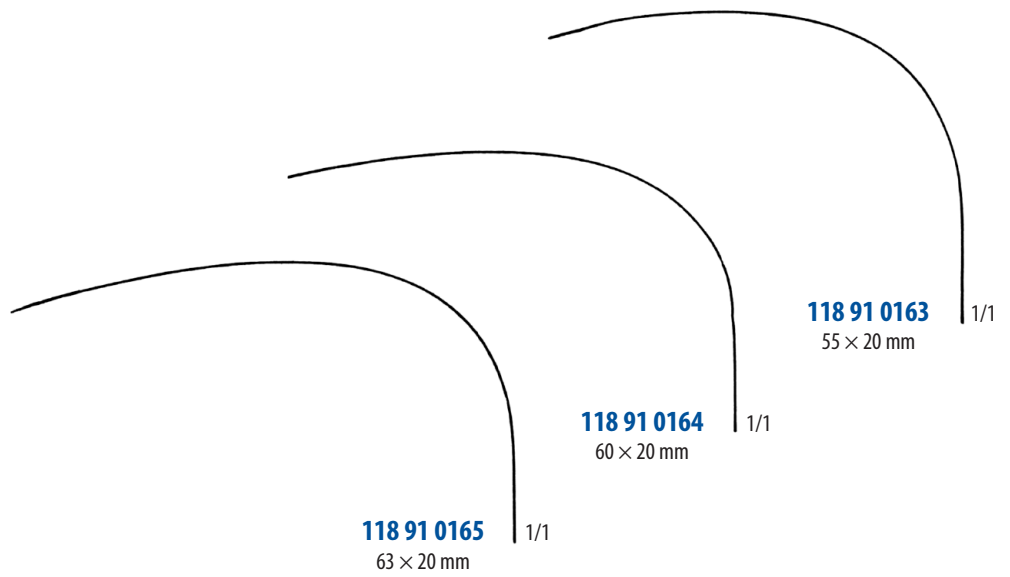

118 91 0165 1/1
63 × 20 mm

118 91 0164 1/1
60 × 20 mm

118 91 0163 1/1
55 × 20 mm



LANGENBECK

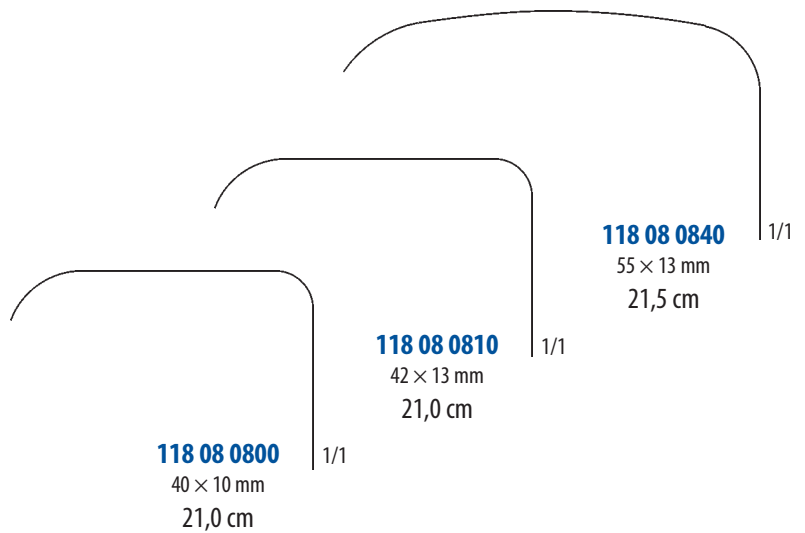

118 08 0800 1/1
40 × 10 mm
21,0 cm

118 08 0810 1/1
42 × 13 mm
21,0 cm

118 08 0840 1/1
55 × 13 mm
21,5 cm



KOCHER
23,0 cm

1/2

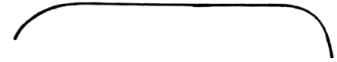

1/1

118 08 1050
40 × 35 mm

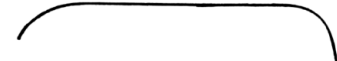

1/1

118 91 0185
40 × 18 mm

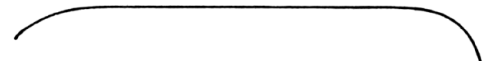

1/1

118 91 0186
60 × 20 mm

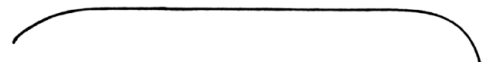

1/1

118 91 0187
60 × 25 mm

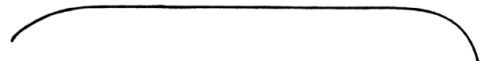

1/1

118 91 0188
75 × 30 mm

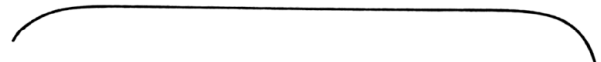

1/1

118 08 1060
70 × 35 mm

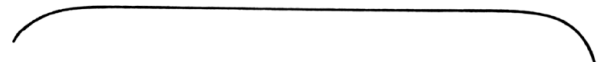

1/1

118 91 0189
75 × 40 mm

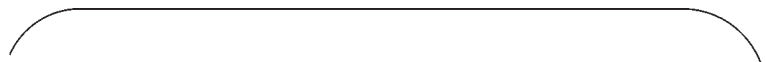

1/1

118 08 1070
100 × 40 mm

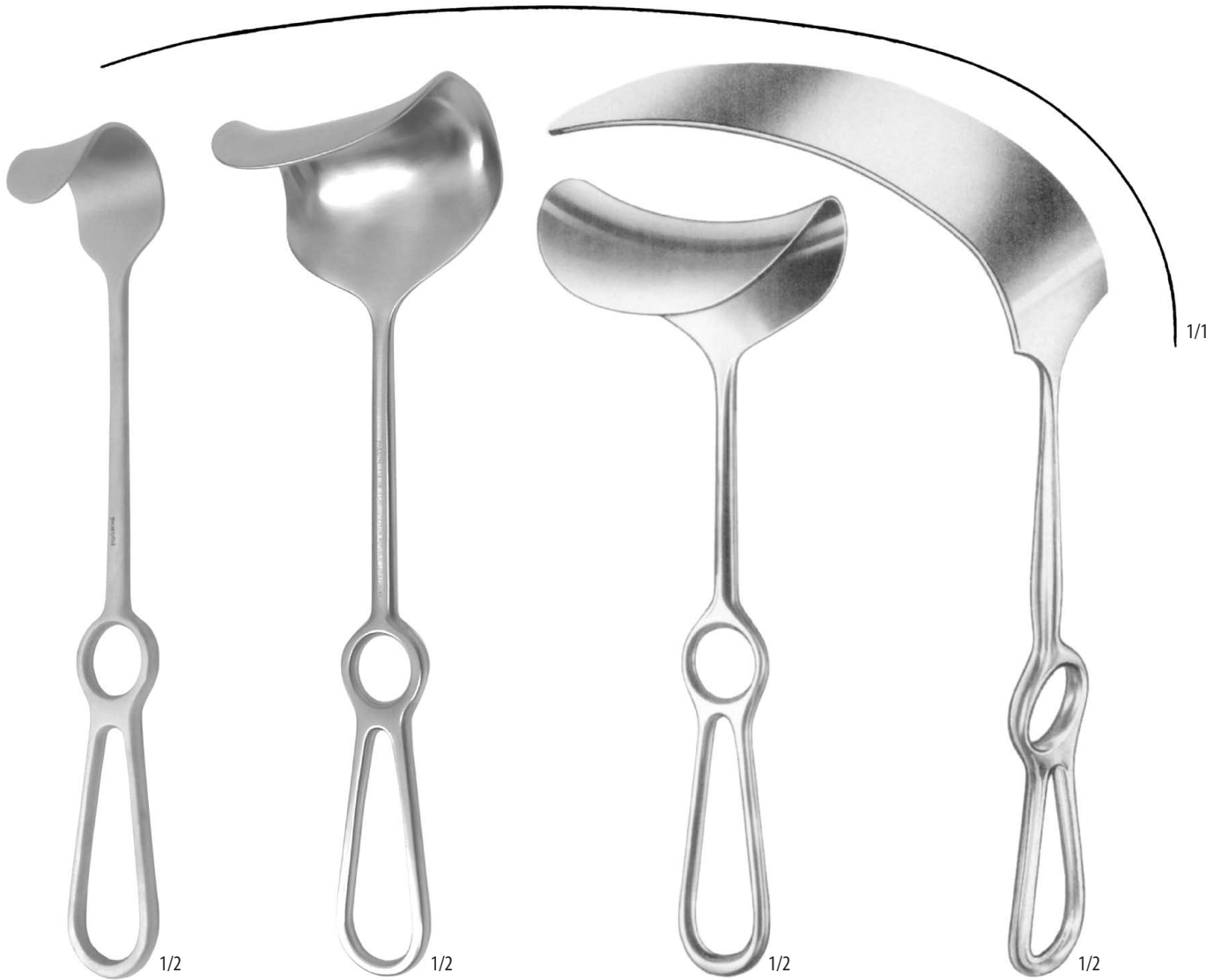

FRITSCH
118 08 1120
40 × 35 mm
25,5 cm

FRITSCH
118 08 1130
50 × 80 mm
27,5 cm

FRITSCH
24,0 cm
118 91 0225 – 45 × 40 mm
118 91 0226 – 45 × 50 mm
118 91 0227 – 45 × 60 mm
118 91 0228 – 45 × 75 mm
118 91 0229 – 65 × 85 mm

KELLY
27,0 cm
118 91 0249 – 160 × 38 mm
118 91 0250 – 160 × 57 mm
118 91 0251 – 190 × 38 mm
118 91 0252 – 190 × 57 mm

**KOCHER****118 91 0230** – 22,0 cm – 70 × 25 mm**118 08 0550** – 25,0 cm – 80 × 40 mm**118 08 0560** – 25,0 cm – 80 × 50 mm**118 91 0233** – 25,0 cm – 80 × 60 mm**MIKULICZ**

26,0 cm

118 91 0246 – 85 × 35 mm**118 08 1100** – 115 × 30 mm**118 91 0247** – 120 × 50 mm**118 08 1110** – 135 × 50 mm**118 91 0248** – 155 × 50 mm**HARRINGTON**

32,0 cm

118 91 0242 – 127 × 40 mm**118 91 0243** – 127 × 62 mm**118 91 0244** – 175 × 64 mm



SMELLIE
118 28 0010
32,0 cm



BRAUN
118 91 0317
30,0 cm



BEACHAM
118 91 0395
26,0 cm



EMMET
22,0 cm



118 91 0388



118 91 0389



118 91 0390



118 91 0391



118 91 00392



SIMON
118 91 0393
22,0 cm



SIMON
118 91 0394
22,0 cm

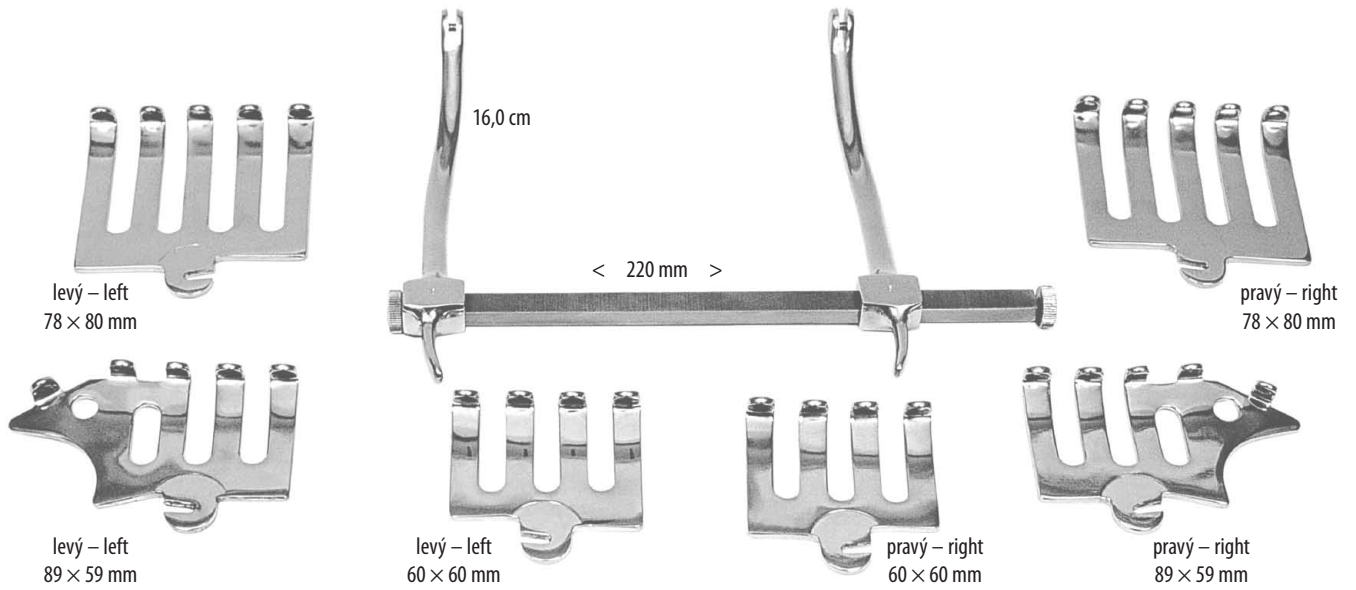

COLLIN
119 08 0260
 sada – set

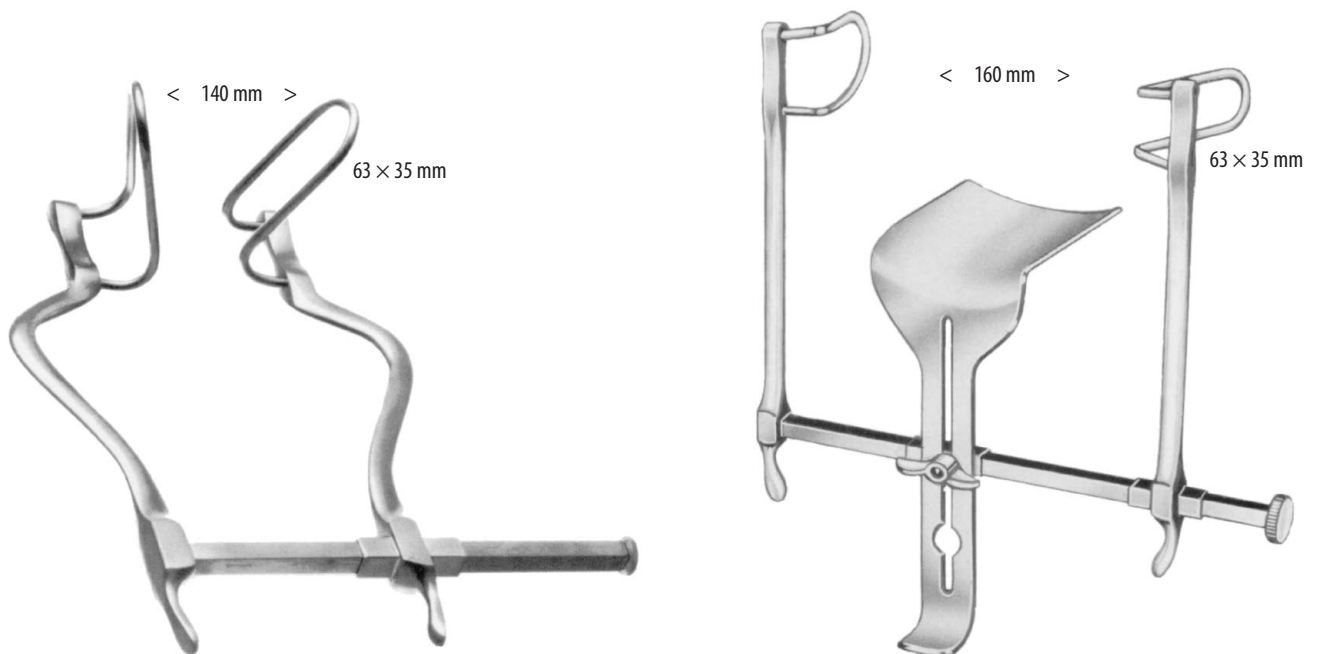

GOSSET
119 91 0118

GOSSET
119 91 0119

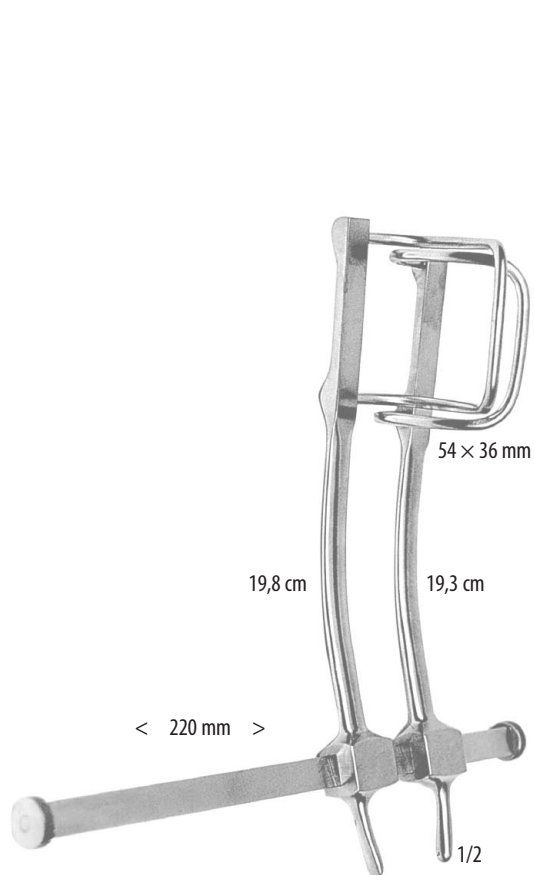

GOSSET
119 08 0250

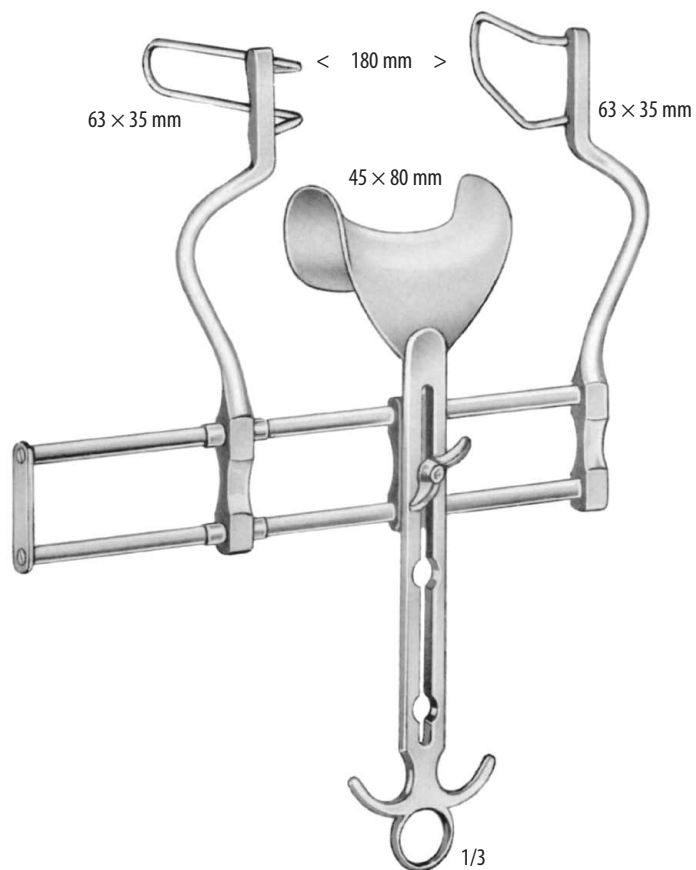

BALFOUR
119 91 0124

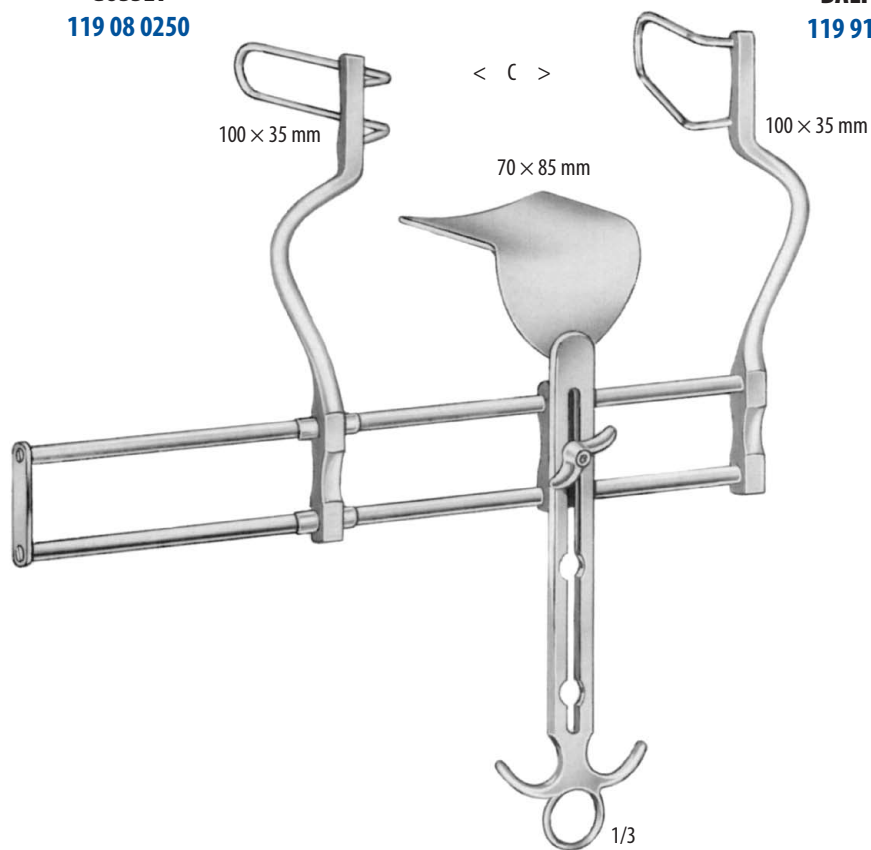

BALFOUR
119 91 0125
C = 200 mm

BALFOUR
119 91 0126
C = 250 mm

119 91 0143

300 × 300 mm

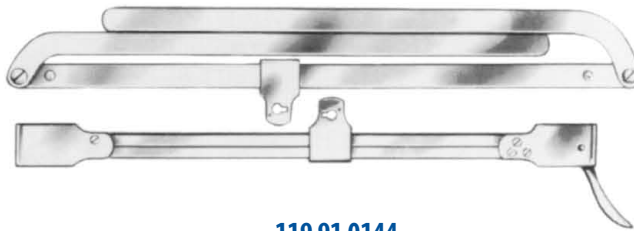
119 91 0144

38 × 60 mm

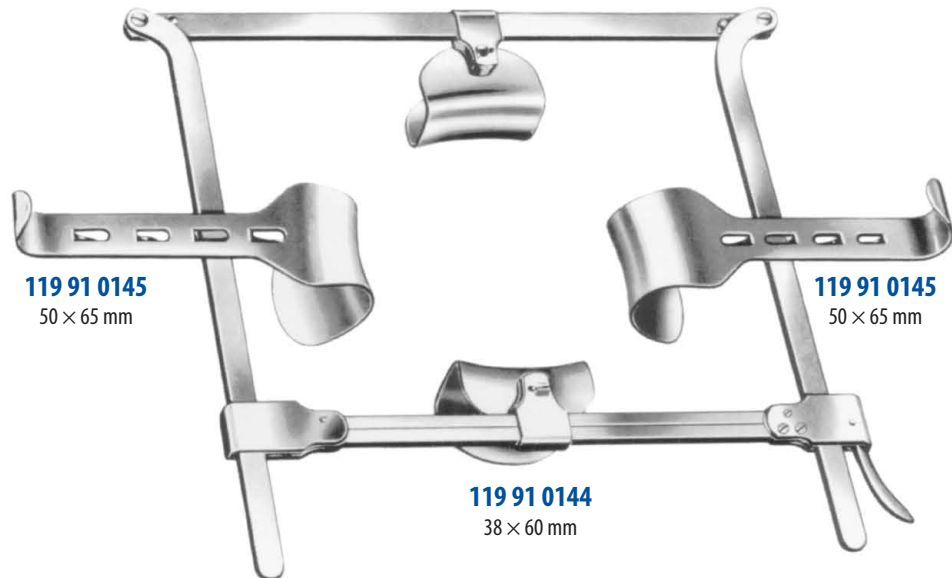
119 91 0145

50 × 65 mm

119 91 0145

50 × 65 mm

119 91 0144

38 × 60 mm

119 91 0147

45 × 80 mm

119 91 0148

60 × 85 mm

119 91 0148

60 × 85 mm

119 91 0147

45 × 80 mm

FRANZ
119 91 0142

sada – set

119 91 0143 – 1×

119 91 0144 – 2×

119 91 0145 – 2×

FRANZ
119 91 0146

sada – set

119 91 0143 – 1×

119 91 0144 – 2×

119 91 0145 – 2×

119 91 0147 – 2×

119 91 0148 – 2×

119 91 0149

105 × 35 mm

119 91 0150

98 × 50 mm



119 91 0135

119 91 0136
110 × 70 mm119 91 0137
80 × 45 mm**O'SULLIVAN-O'CONNOR**

119 91 0134

sada – set

119 91 0135 – 1×

119 91 0136 – 1×

119 91 0137 – 2×

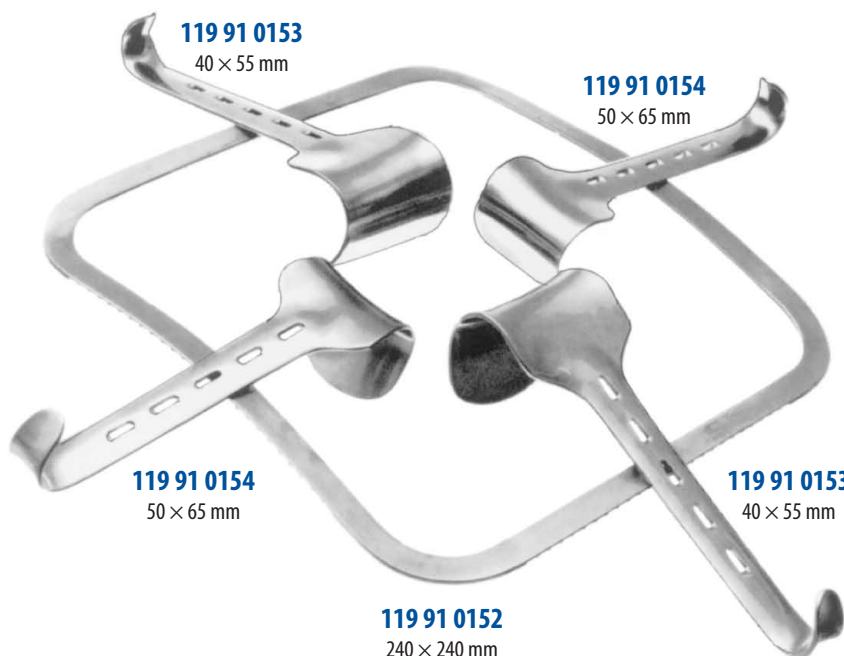
119 91 0153
40 × 55 mm119 91 0154
50 × 65 mm119 91 0154
50 × 65 mm119 91 0153
40 × 55 mm119 91 0152
240 × 240 mm119 91 0155
78 × 65 mm119 91 0156
80 × 90 mm**KIRSCHNER**

119 91 0151

sada – set

119 91 0152 – 1×

119 91 0153 – 2×

119 91 0154 – 2×

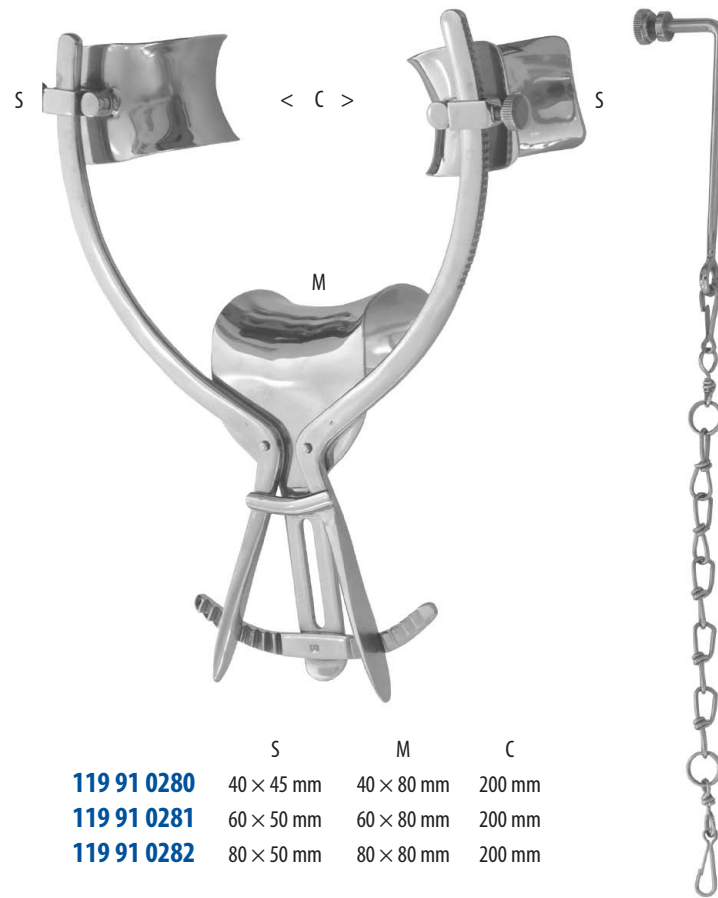

	S	M	C
119 91 0280	40 × 45 mm	40 × 80 mm	200 mm
119 91 0281	60 × 50 mm	60 × 80 mm	200 mm
119 91 0282	80 × 50 mm	80 × 80 mm	200 mm

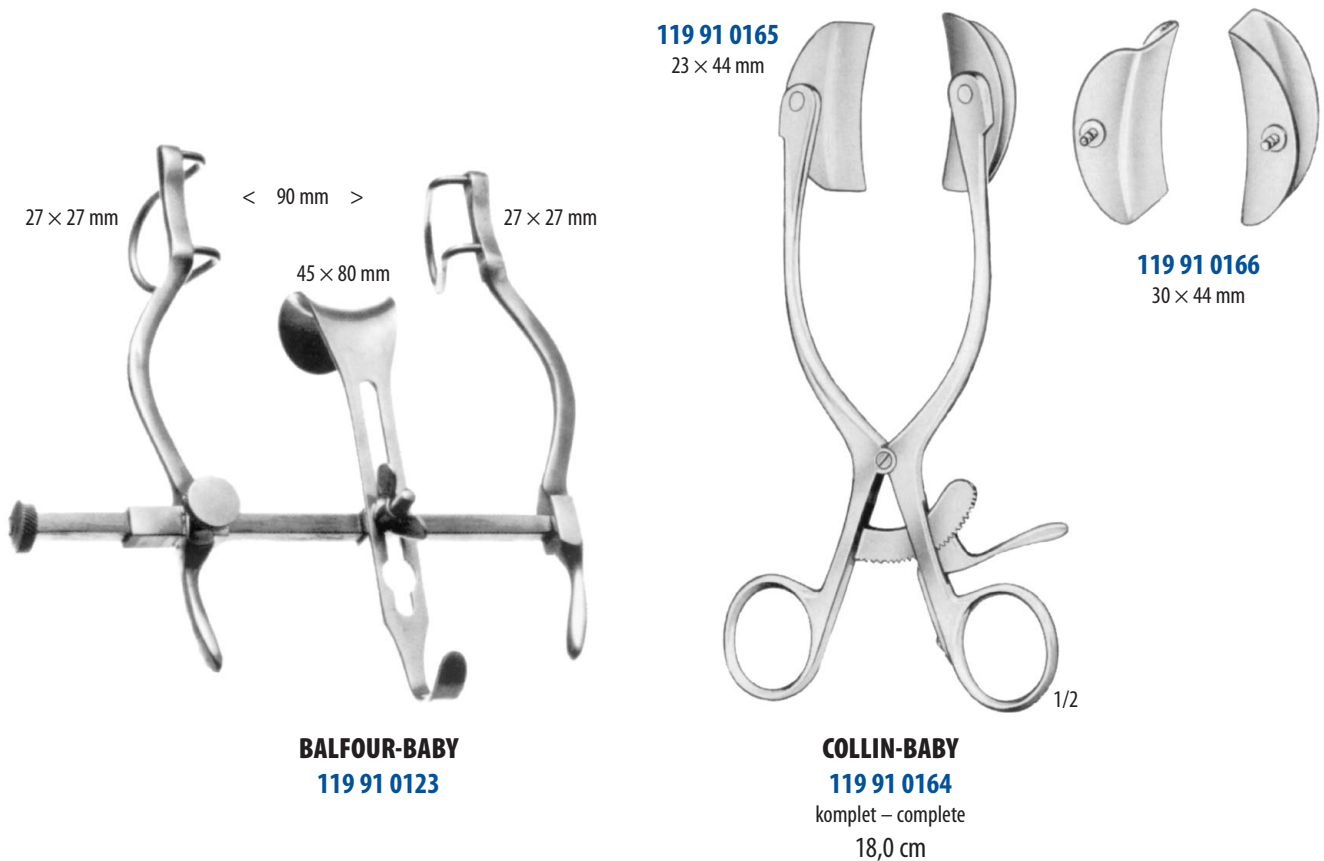
 ROZVĚRAČE BŘIŠNÍ DĚTSKÉ
ABDOMINAL RETRACTORS CHILDREN

BALFOUR-BABY
119 91 0123

COLLIN-BABY
119 91 0164
komplet – complete
18,0 cm

ROZVĚRAČE BŘÍŠNÍ
ABDOMINAL RETRACTORS



COLLIN
119 91 0169
22,0 cm

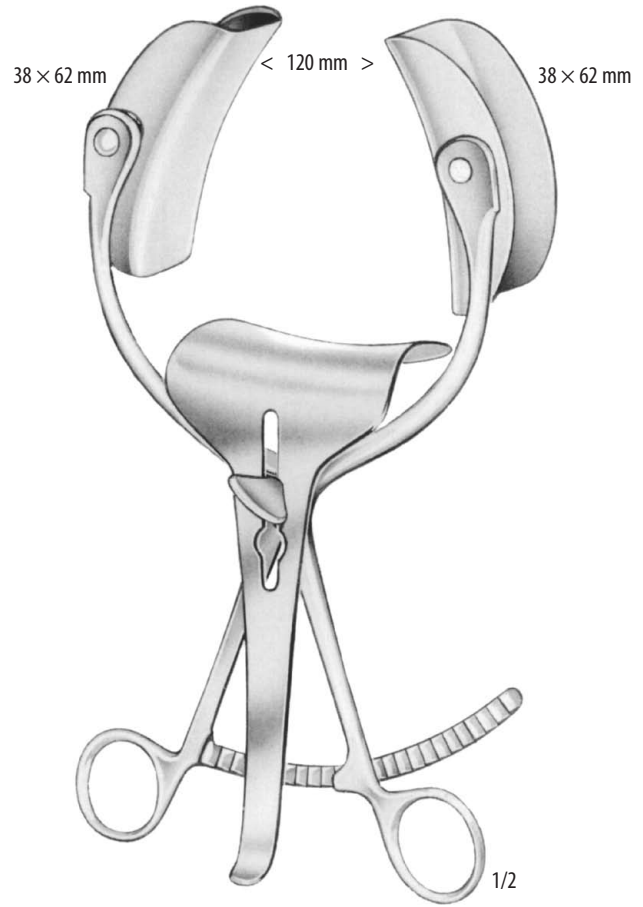

COLLIN
119 91 0170
24,0 cm

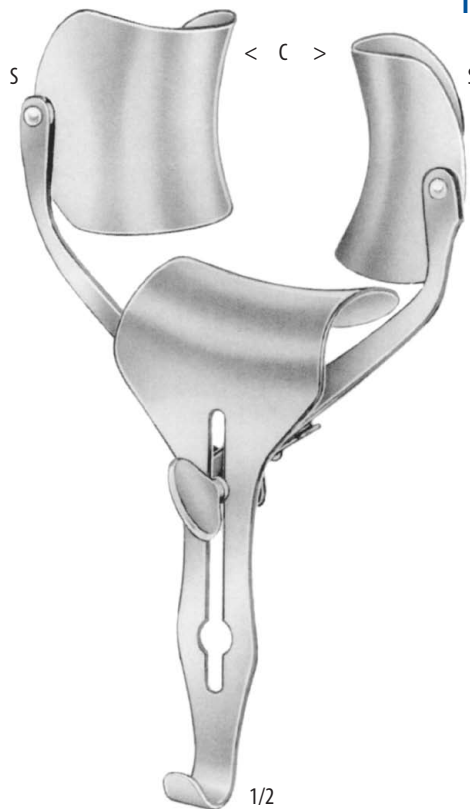

RICARD	S	M	C
119 91 0173	72 x 85 mm	80 x 90 mm	280 mm
119 91 0174	60 x 80 mm	55 x 70 mm	300 mm

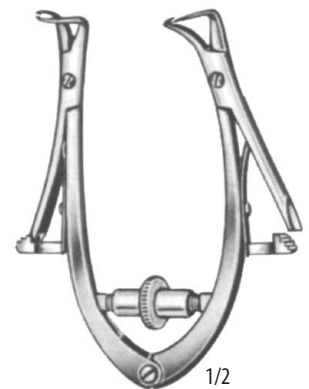

FRIEDMANN
119 91 0167
10,0 cm



1/2

121 08 0050

33,0 cm

ohébná – malleable

40 mm



122 27 0350
23,8 cm



122 27 0370
24,0 cm



122 27 0380
23,5 cm



122 27 0400
23,5 cm



122 27 0420
16,9 cm



122 27 0440
16,9 cm



90°
šířka – width
35 mm

1/2

122 27 0450
16,9 cm

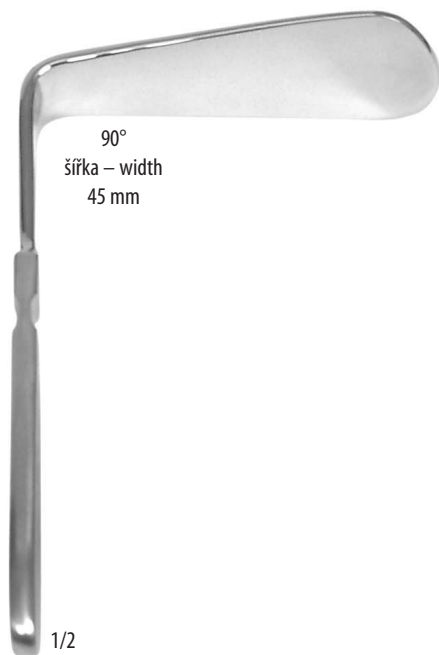

90°
šířka – width
45 mm

1/2

122 27 0470
16,9 cm



115 × 28 mm

1/2

KRISTELLER
122 27 0490
sada – set
22,4 cm

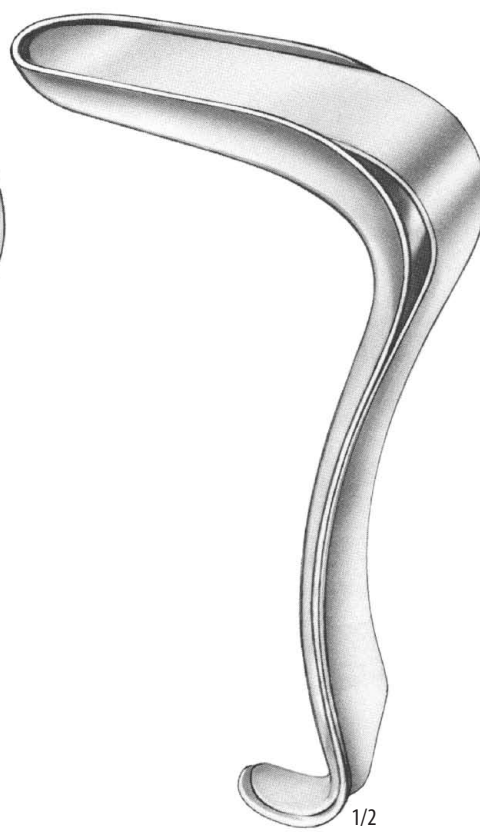
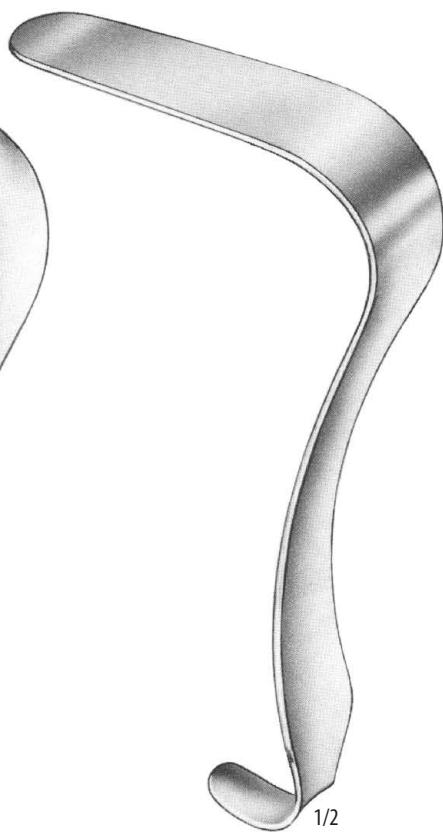
**KRISTELLER**

a × b

Fig. 1	122 91 0094	70 × 27 mm
Fig. 2	122 91 0095	80 × 30 mm
Fig. 3	122 91 0096	90 × 36 mm

kúželovité
conic

Fig. 00	122 91 0103	105 × 18 mm
Fig. 0	122 91 0104	105 × 21 mm



Fig. 1	122 91 0109	105 × 26 mm
Fig. 2	122 91 0110	105 × 28 mm
Fig. 3	122 91 0111	105 × 33 mm

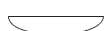
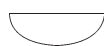

Fig. 1	122 91 0118	110 × 27 mm
Fig. 2	122 91 0119	110 × 30 mm
Fig. 3	122 91 0120	110 × 36 mm

KRISTELLER

a × b

Fig. 1	122 91 0097	75 × 23 mm
Fig. 2	122 91 0098	85 × 26 mm
Fig. 3	122 91 0099	100 × 32 mm

Fig. 00	122 91 0105	110 × 14 mm
Fig. 0	122 91 0106	110 × 17 mm

Fig. 1	122 91 0112	115 × 22 mm
Fig. 2	122 91 0113	115 × 24 mm
Fig. 3	122 91 0114	115 × 29 mm

Fig. 1	122 91 0121	115 × 23 mm
Fig. 2	122 91 0122	115 × 26 mm
Fig. 3	122 91 0123	115 × 32 mm

KRISTELLER

sada – set

122 91 0100
122 91 0101
122 91 0102

122 91 0107
122 91 0108

122 91 0115
122 91 0116
122 91 0117

122 91 0124
122 91 0125
122 91 0126



SIMS
122 91 0091
60 × 25/30 mm



SIMS
122 91 0092
70 × 30/35 mm

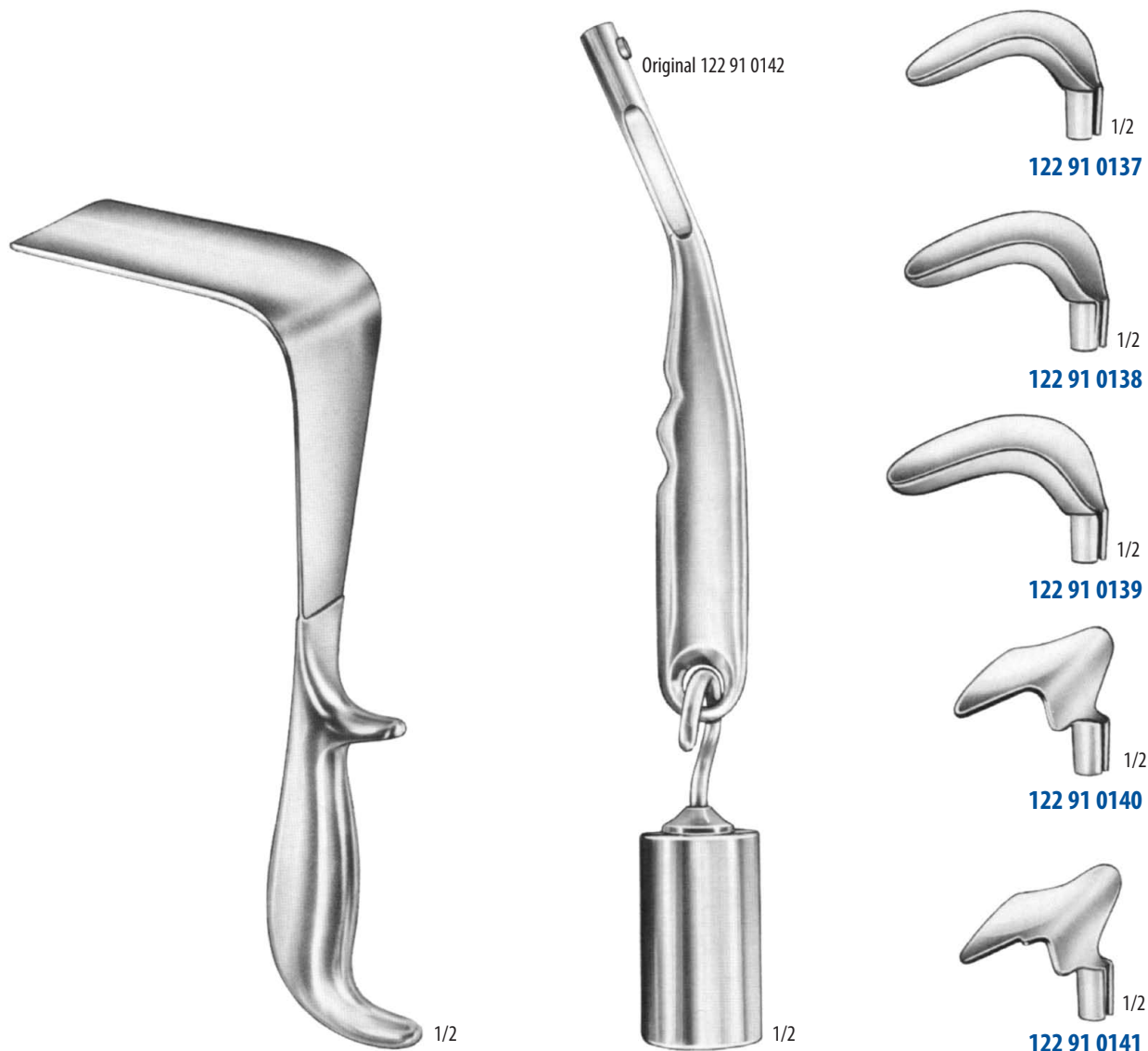

SIMS
122 91 0093
80 × 35/40 mm

**DOYEN**

a × b

Fig. 1	122 91 0127	55 × 35 mm
Fig. 2	122 91 0128	85 × 35 mm
Fig. 3	122 91 0129	115 × 36 mm
Fig. 1	122 91 0130	55 × 45 mm
Fig. 2	122 91 0131	85 × 45 mm
Fig. 3	122 91 0132	115 × 45 mm
Fig. 1	122 91 0133	55 × 60 mm
Fig. 2	122 91 0134	85 × 60 mm
Fig. 3	122 91 0135	115 × 60 mm

SCHERBACK**122 91 0143** – 400g**122 91 0144** – 800g

122 91 0136	122 91 0145
sada – set	sada – set
122 91 0137	122 91 0137
122 91 0138	122 91 0138
122 91 0139	122 91 0139
122 91 0140	122 91 0140
122 91 0141	122 91 0141
122 91 0142	122 91 0142
122 91 0143	122 91 0144



AUVARD

122 91 0146 80 × 38 mm
122 91 0147 102 × 45 mm



BREISKY

122 91 0149 100 × 20 mm
122 91 0150 100 × 25 mm
122 91 0151 100 × 30 mm
122 91 0152 100 × 35 mm
122 91 0153 100 × 40 mm

122 91 0154 130 × 20 mm
122 91 0155 130 × 25 mm
122 91 0156 130 × 30 mm
122 91 0157 130 × 35 mm
122 91 0158 130 × 40 mm

122 91 0159 155 × 40 mm



LANDAU

122 91 0160 105 × 28 mm
122 91 0161 105 × 38 mm

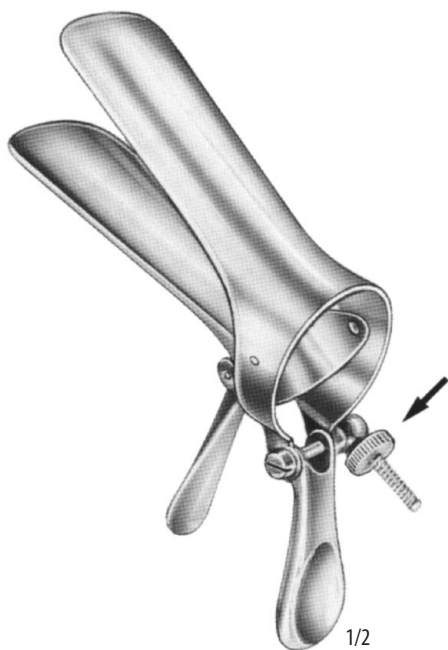

1/2

CUSCO

122 91 0001	75 × 32 mm
122 91 0002	85 × 35 mm
122 91 0003	100 × 35 mm

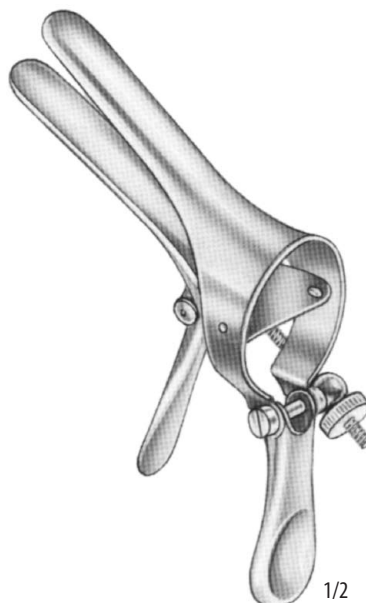

1/2

CUSCO-VIRGIN

122 91 0004	75 × 17 mm
--------------------	------------

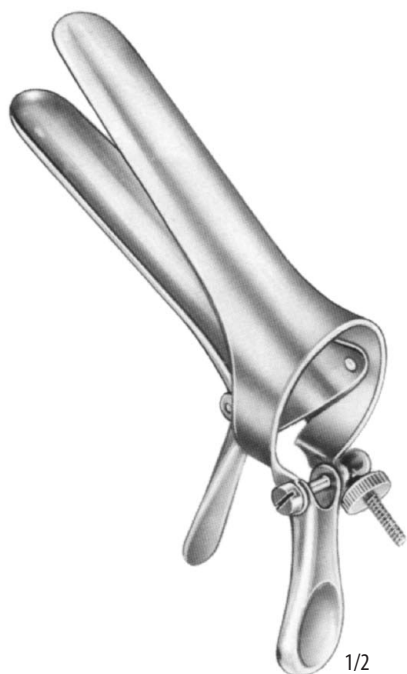

1/2

CUSCO-SUISSE

122 91 0005	80 × 22 mm
122 91 0006	100 × 25 mm
122 91 0007	105 × 27 mm

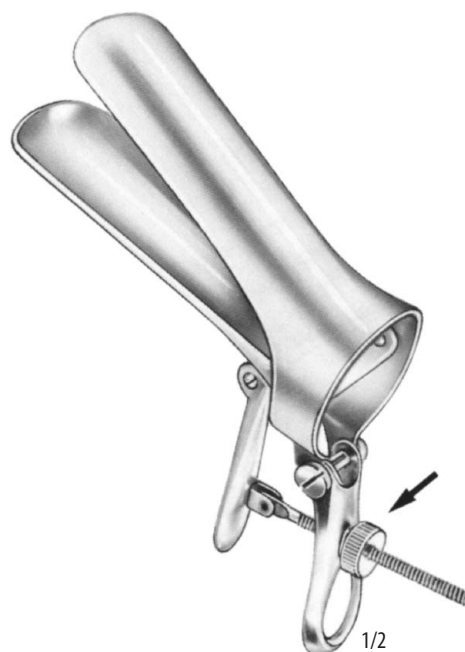

1/2

CUSCO

122 91 0008	74 × 32 mm
122 91 0009	85 × 35 mm
122 91 0010	100 × 37 mm

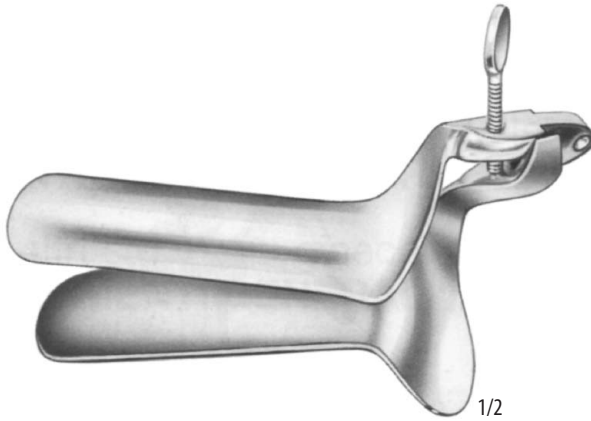

1/2

COLLIN

- 122 91 0011** 85 × 30 mm
- 122 91 0012** 100 × 35 mm
- 122 91 0013** 110 × 40 mm



1/2

PEDERSON

- 122 91 0014** 75 × 13 mm
- 122 91 0015** 100 × 22 mm
- 122 91 0016** 120 × 25 mm

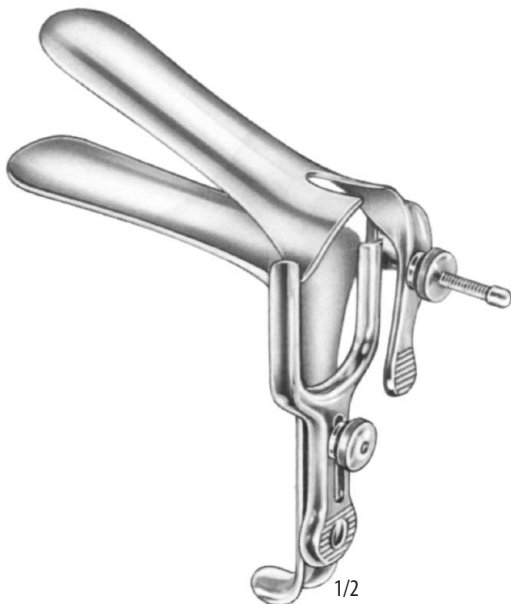

1/2

GRAVE

- 122 91 0017** 75 × 20 mm
- 122 91 0018** 95 × 35 mm
- 122 91 0019** 115 × 35 mm

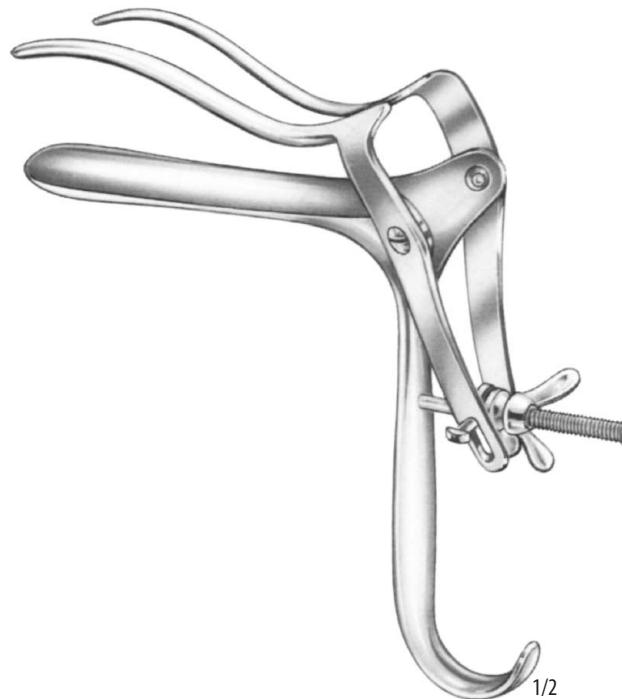

1/2

NOTT

- 122 91 0020** 90 × 30 mm
- 122 91 0021** 110 × 30 mm

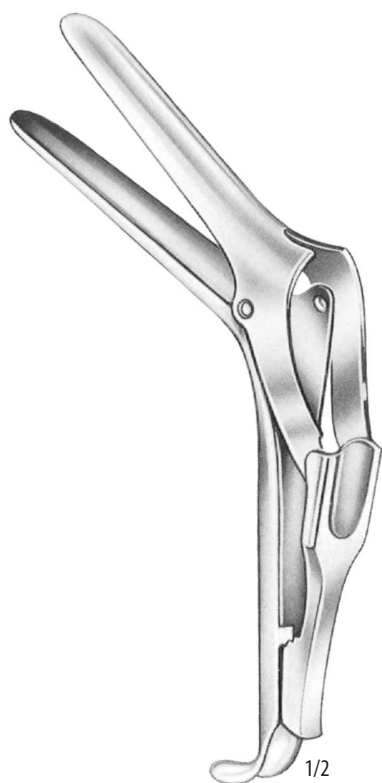
**SEMM**

- 122 91 0022** 90 × 14/18 mm
122 91 0023 100 × 17/20 mm
122 91 0024 100 × 25/30 mm

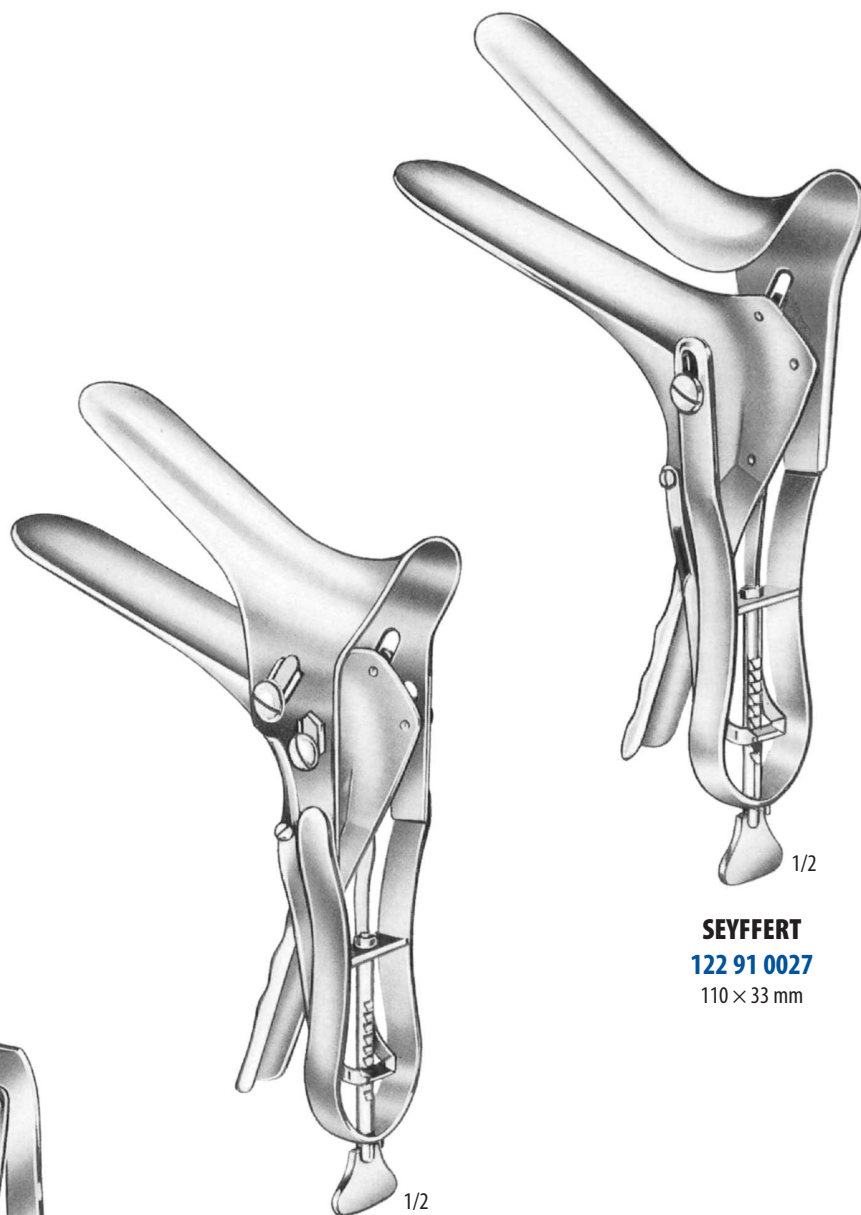

SEYFFERT
122 91 0027
 110 × 33 mm

- SEYFFERT**
122 91 0025 100 × 17 mm
122 91 0026 110 × 33 mm

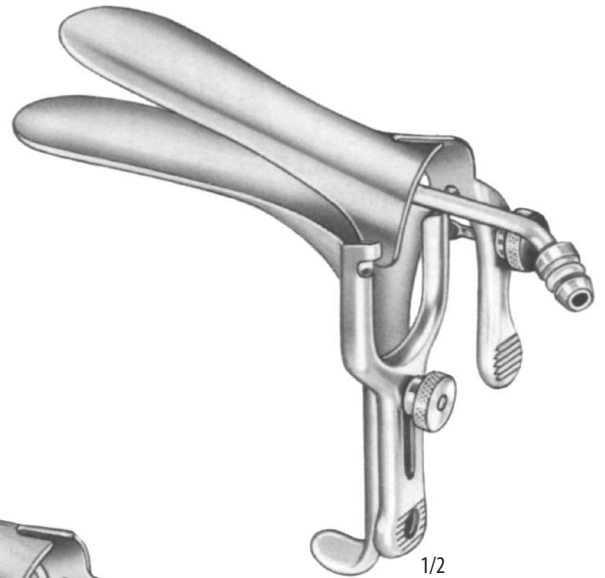

1/2

GRAVE

na horním zrcadle – on upper blade

122 91 0028 75 × 13 mm

122 91 0030 101 × 22 mm

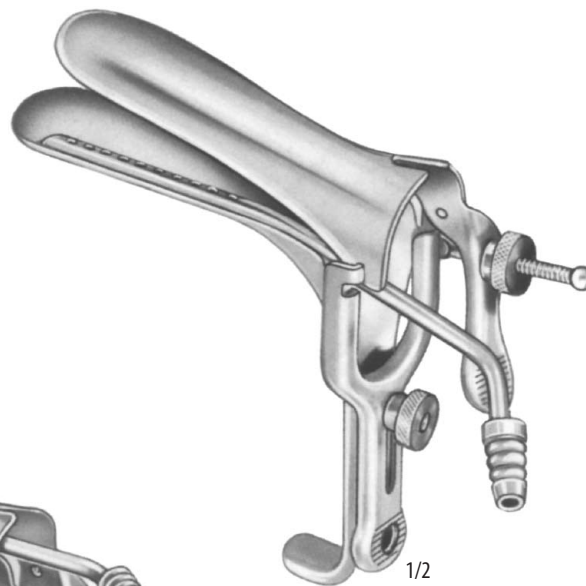
122 91 0032 120 × 35 mm

1/2

GRAVE

na spodním zrcadle – on lower blade

122 91 0034 75 × 13 mm

122 91 0036 101 × 22 mm

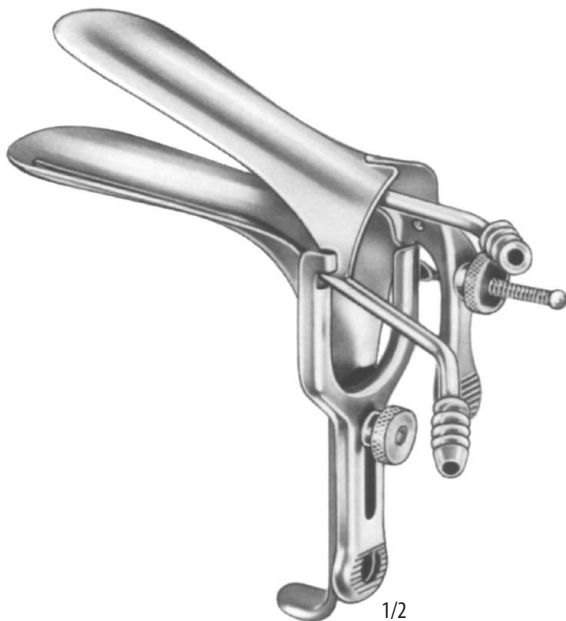
122 91 0038 120 × 35 mm

1/2

GRAVE

na obou zrcadlech – on upper and lower blade

122 91 0040 75 × 13 mm

122 91 0042 101 × 22 mm

122 91 0044 120 × 35 mm

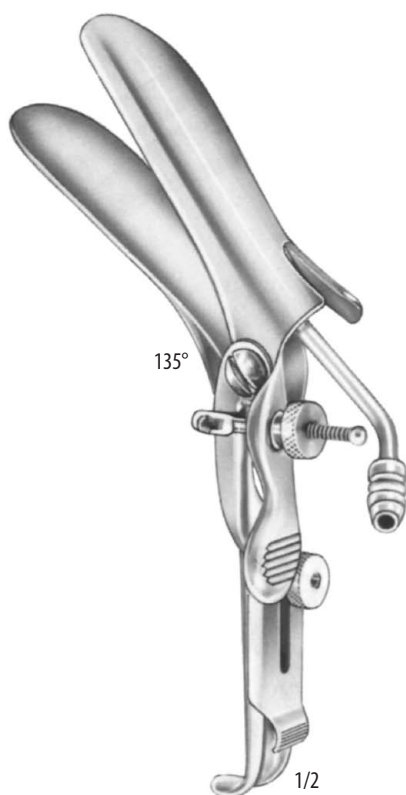
**GRAVE SPECIAL**

na horním zrcadle – on upper blade

122 91 0050 101 × 35 mm

na spodním zrcadle – on lower blade

122 91 0056 101 × 35 mm

na obou zrcadlech – on upper and lower blade

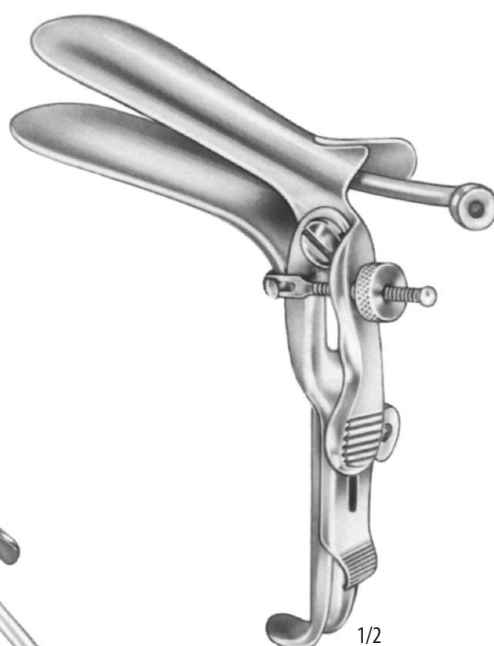
122 91 0062 101 × 35 mm**GRAVE SPECIAL**

na horním zrcadle – on upper blade

122 91 0048 101 × 35 mm

na spodním zrcadle – on lower blade

122 91 0054 101 × 35 mm

na obou zrcadlech – on upper and lower blade

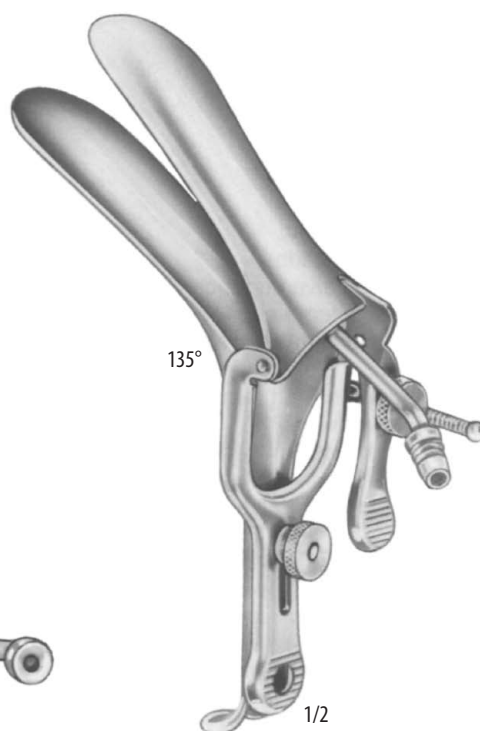
122 91 0060 101 × 35 mm**GRAVE SPECIAL**

na horním zrcadle – on upper blade

122 91 0046 101 × 35 mm

na spodním zrcadle – on lower blade

122 91 0052 101 × 35 mm

na obou zrcadlech – on upper and lower blade

122 91 0058 101 × 35 mm

PEDERSON

na horním zrcadle – on upper blade

122 91 0064	76 × 13 mm
122 91 0066	101 × 22 mm
122 91 0068	120 × 25 mm

na spodním zrcadle – on lower blade

122 91 0070	76 × 13 mm
122 91 0072	101 × 22 mm
122 91 0074	120 × 25 mm

na obou zrcadlech – on upper and lower blade

122 91 0076	76 × 13 mm
122 91 0078	101 × 22 mm
122 91 0080	120 × 25 mm

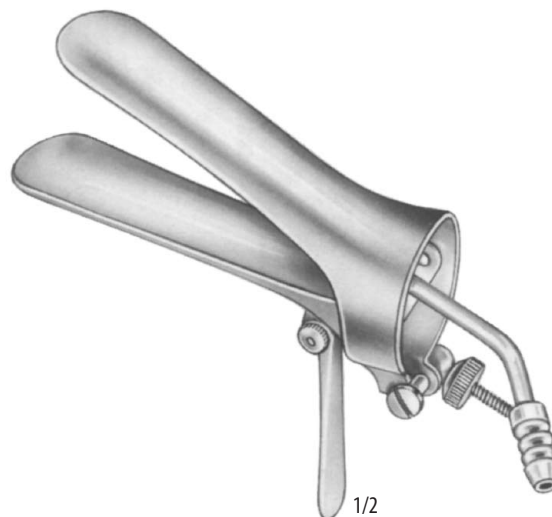
CUSCO

na horním zrcadle – on upper blade

122 91 0082	105 × 25 mm
122 91 0083	107 × 29 mm
122 91 0084	115 × 35 mm

na spodním zrcadle – on lower blade

122 91 0085	105 × 25 mm
122 91 0086	107 × 29 mm
122 91 0087	115 × 35 mm

na obou zrcadlech – on upper and lower blade

122 91 0088	105 × 25 mm
122 91 0089	107 × 29 mm
122 91 0090	115 × 35 mm

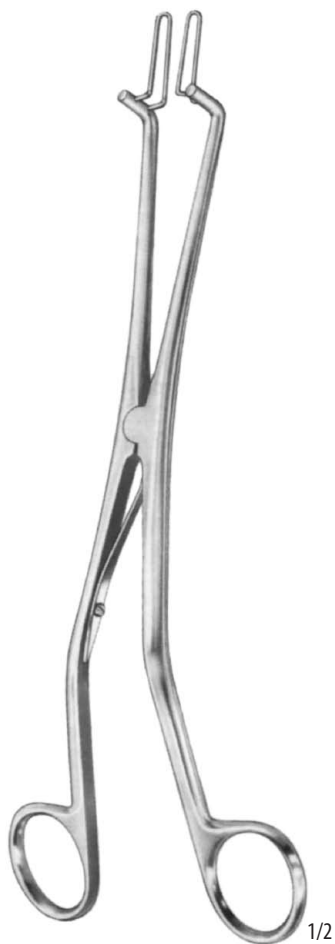

KOGAN
122 91 0168
24,0 cm

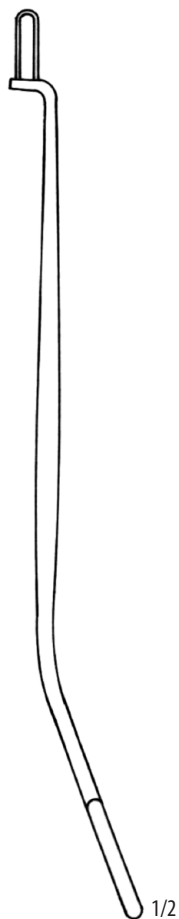

KOGAN
122 91 0169
24,0 cm



KOGAN
122 91 0170 3 mm
122 91 0171 7 mm



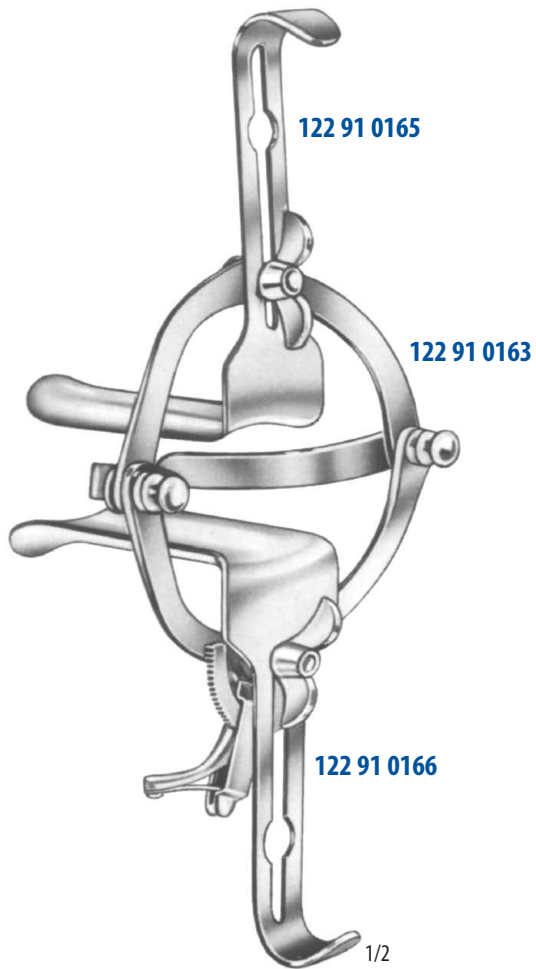

O'SULLIVAN-O'CONNOR

122 91 0162

komplet – complete

122 91 0163 – 1×

122 91 0164 – 1×

122 91 0165 – 1×

122 91 0166 – 1×

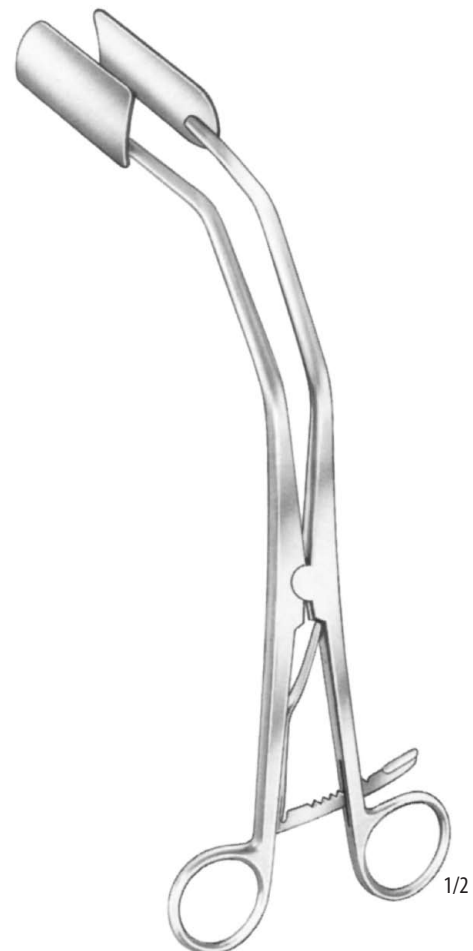

NEW PORT

122 91 0148

25,0 cm



1/2

AYER
124 27 0011
22,0 cm



125 27 0050
30,0 cm



125 27 0060
30,0 cm



RECAMIER
125 27 0120
31,0 cm

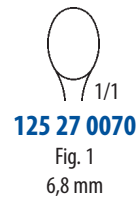

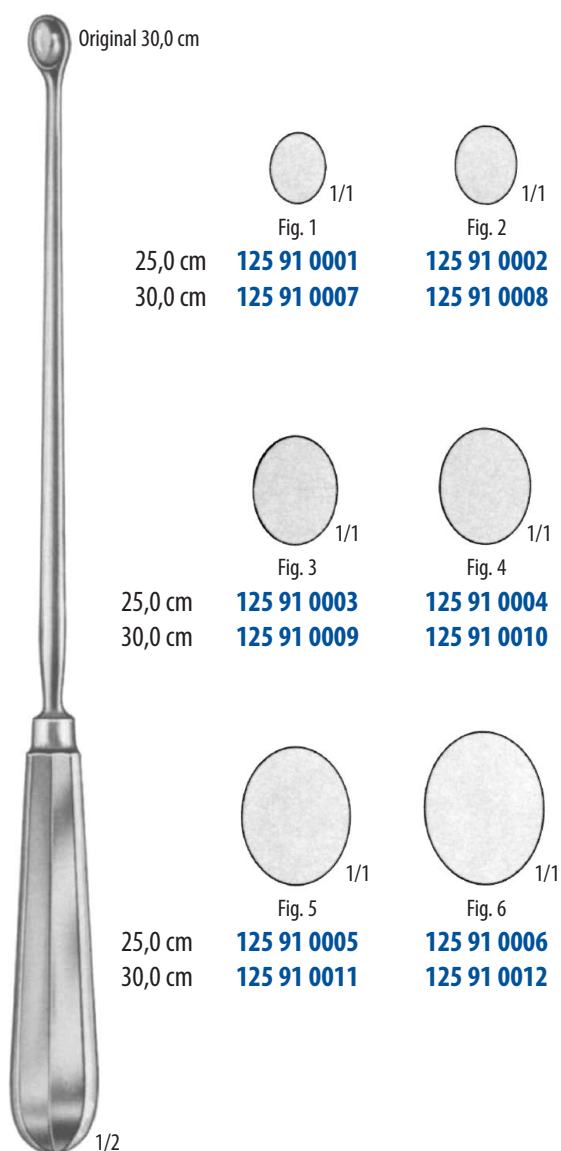
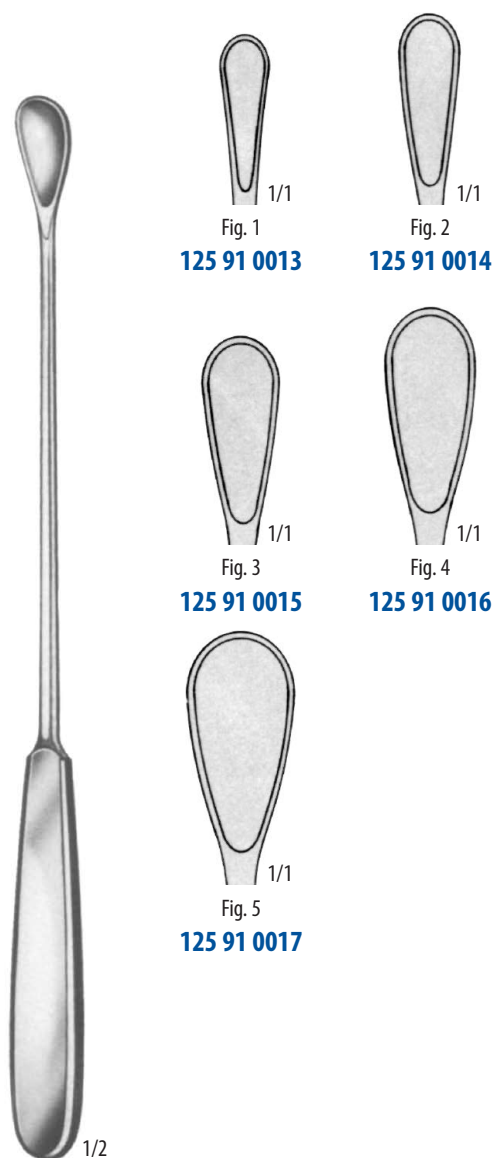
**SIMON/SCHRÖDER****GOURDET**

28,0 cm



1/2

WALLICH
125 91 0018
42,0 cm



COLLIN
126 91 0088
28,0 cm

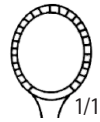

126 91 0088
8,0 mm

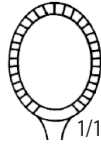

126 91 0089
10,0 mm

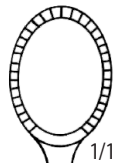

126 91 0090
12,0 mm

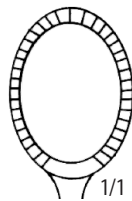

126 91 0091
14,0 mm



BLAKE
126 91 0092
27,0 cm

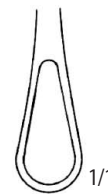

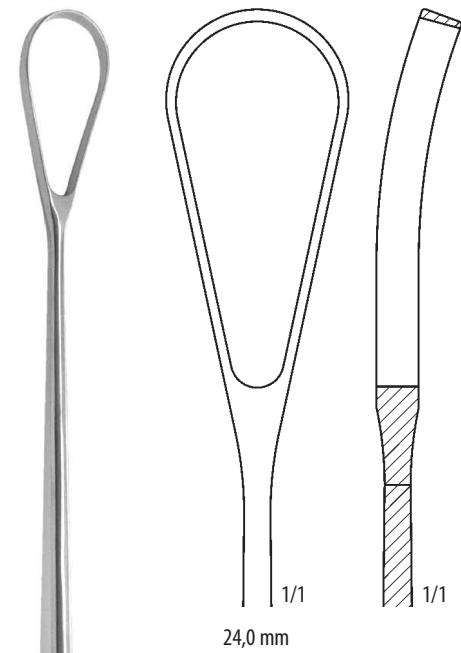

BUMM
126 27 0641
31,0 cm

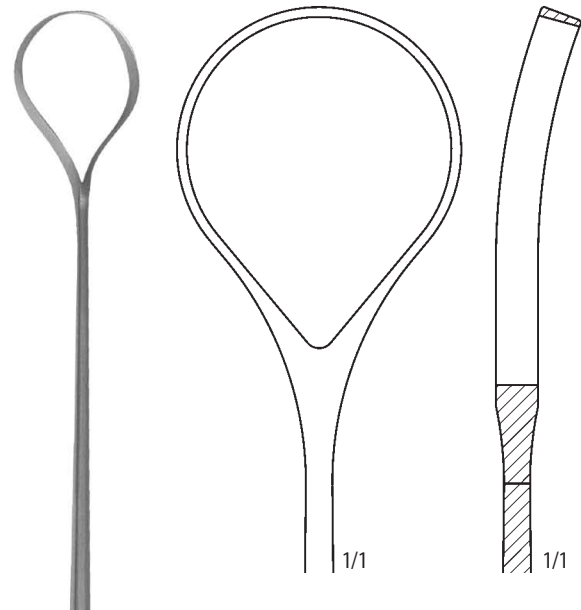

BUMM
126 27 0691
30,8 cm

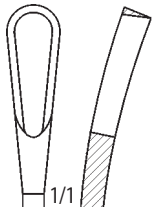

Fig. 1

126 27 0010
126 27 0011
126 27 0012

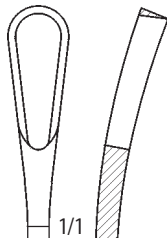

Fig. 2

126 27 0020
126 27 0021
126 27 0022

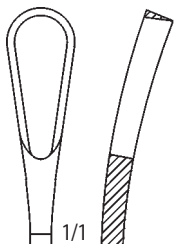

Fig. 3

126 27 0030
126 27 0031
126 27 0032

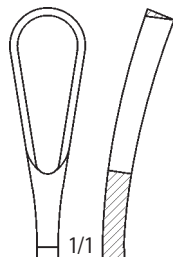

Fig. 4

126 27 0040
126 27 0041
126 27 0042

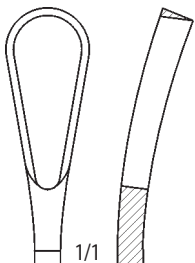

Fig. 5

126 27 0050
126 27 0051
126 27 0052

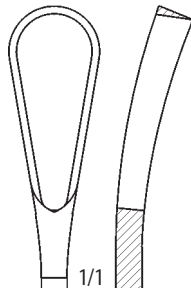

Fig. 6

126 27 0060
126 27 0061
126 27 0062

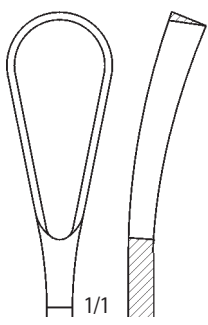

Fig. 7

126 27 0070
126 27 0071
126 27 0072

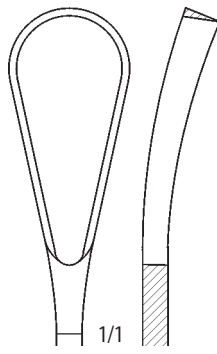

Fig. 8

126 27 0080
126 27 0081
126 27 0082



1/2

126 27 0010 ÷ 126 27 0080
29,0 cm



1/2

126 27 0011 ÷ 126 27 0081
29,0 cm



1/2

126 27 0012 ÷ 126 27 0082
29,0 cm

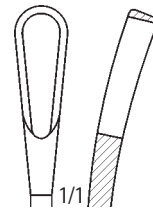

Fig. 1

126 27 0110
126 27 0111
126 27 0112

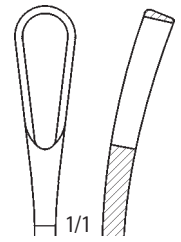

Fig. 2

126 27 0120
126 27 0121
126 27 0122

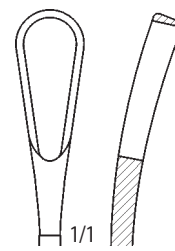

Fig. 3

126 27 0130
126 27 0131
126 27 0132

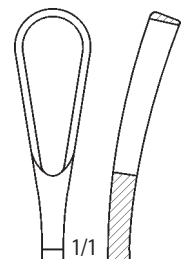

Fig. 4

126 27 0140
126 27 0141
126 27 0142

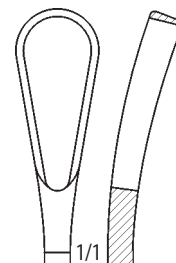

Fig. 5

126 27 0150
126 27 0151
126 27 0152

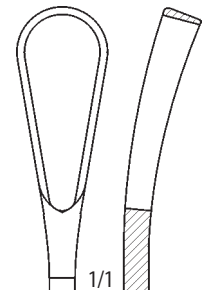

Fig. 6

126 27 0160
126 27 0161
126 27 0162

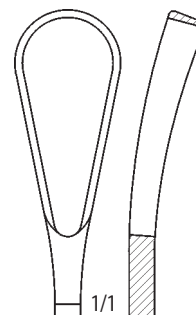

Fig. 7

126 27 0170
126 27 0171
126 27 0172

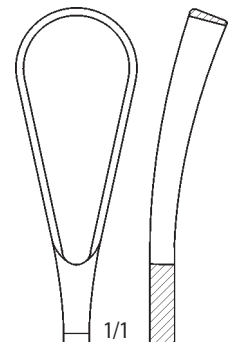

Fig. 8

126 27 0180
126 27 0181
126 27 0182



1/2

126 27 0110 ÷ 126 27 0180
29,0 cm



1/2

126 27 0111 ÷ 126 27 0181
29,0 cm



1/2

126 27 0112 ÷ 126 27 0182
29,0 cm

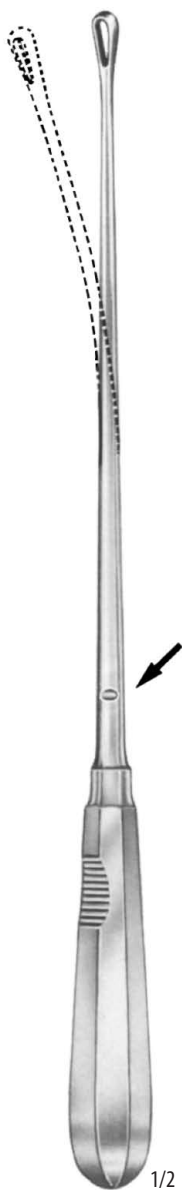

1/2

RECAMIER/SIMS

ohebné – malleable

31,0 cm

31,0 cm		RECAMIER/SIMS		26,0 cm	
126 91 0032	5,0 mm	Fig. 00	5,0 mm	126 91 0046	
126 91 0033	6,0 mm	Fig. 0	6,0 mm	126 91 0047	
126 91 0034	7,0 mm	Fig. 1	7,0 mm	126 91 0048	
126 91 0035	8,0 mm	Fig. 2	8,0 mm	126 91 0049	
126 91 0036	9,0 mm	Fig. 3	9,0 mm	126 91 0050	
126 91 0037	11,0 mm	Fig. 4	11,0 mm	126 91 0051	
126 91 0038	12,0 mm	Fig. 5	12,0 mm	126 91 0052	
126 91 0039	14,0 mm	Fig. 6	14,0 mm	126 91 0053	
126 91 0040	15,0 mm	Fig. 7	15,0 mm	126 91 0054	
126 91 0041	16,0 mm	Fig. 8	16,0 mm	126 91 0055	
126 91 0042	19,0 mm	Fig. 9	19,0 mm	126 91 0056	
126 91 0043	20,0 mm	Fig. 10	20,0 mm	126 91 0057	
126 91 0044	21,0 mm	Fig. 11	21,0 mm	126 91 0058	
126 91 0045	23,0 mm	Fig. 12	23,0 mm	126 91 0059	



1/2

RECAMIER/SIMS

ohebné – malleable

26,0 cm

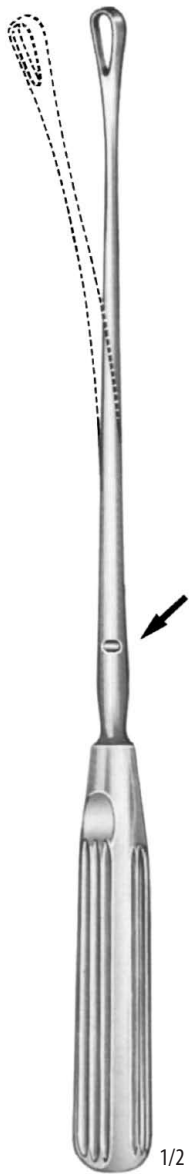

SIMS/RECAMIER
ohebné – malleable
31,0 cm

31,0 cm

126 91 0060
126 91 0061
126 91 0062
126 91 0063
126 91 0064
126 91 0065
126 91 0066
126 91 0067
126 91 0068
126 91 0069
126 91 0070
126 91 0071
126 91 0072
126 91 0073

5,0 mm
 6,0 mm
 7,0 mm
 8,0 mm
 9,0 mm
 11,0 mm
 12,0 mm
 14,0 mm
 15,0 mm
 16,0 mm
 19,0 mm
 20,0 mm
 21,0 mm
 23,0 mm

SIMS/RECAMIER

Fig. 00
 Fig. 0
 Fig. 1
 Fig. 2
 Fig. 3
 Fig. 4
 Fig. 5
 Fig. 6
 Fig. 7
 Fig. 8
 Fig. 9
 Fig. 10
 Fig. 11
 Fig. 12

5,0 mm
 6,0 mm
 7,0 mm
 8,0 mm
 9,0 mm
 11,0 mm
 12,0 mm
 14,0 mm
 15,0 mm
 16,0 mm
 19,0 mm
 20,0 mm
 21,0 mm
 23,0 mm

26,0 cm

126 91 0074
126 91 0075
126 91 0076
126 91 0077
126 91 0078
126 91 0079
126 91 0080
126 91 0081
126 91 0082
126 91 0083
126 91 0084
126 91 0085
126 91 0086
126 91 0087

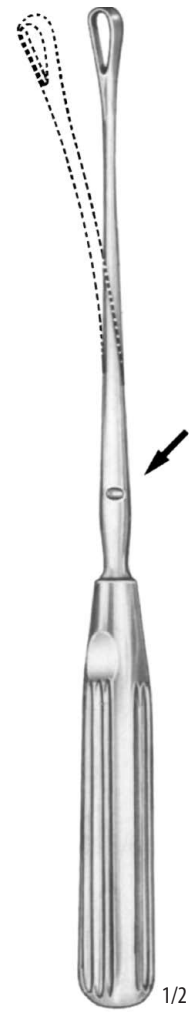

SIMS/RECAMIER
ohebné – malleable
26,0 cm



MILAN
28,0 cm



126 91 0021
4,0 mm



126 91 0022
6,0 mm



126 91 0023
9,0 mm



SPOJKA – CONNECTOR
126 91 0024



průměr – diameter

126 91 0025	3,0 mm
126 91 0026	4,5 mm
126 91 0027	6,0 mm
126 91 0028	8,0 mm
126 91 0029	10,0 mm
126 91 0030	12,0 mm
126 91 0031	14,0 mm



RANDALL
126 91 0095
24,0 cm
průměr – diameter
4,0 mm



NOVAK
126 91 0096 **126 91 0097**
23,0 cm 23,0 cm
průměr – diameter
2,0 mm 4,0 mm



NOVAK
126 91 0098
23,0 cm
průměr – diameter
4,0 mm



KEVORKIAN
126 91 0099
30,0 cm



KEVORKIAN
126 91 0163
30,0 cm



DOYEN
126 91 0093
17,0 cm

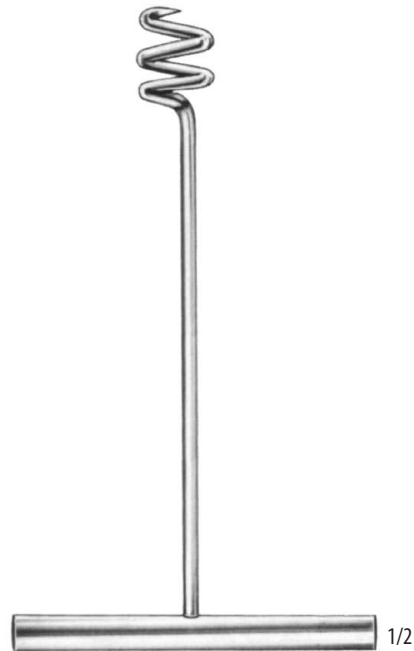

DOYEN
126 91 0094
17,0 cm

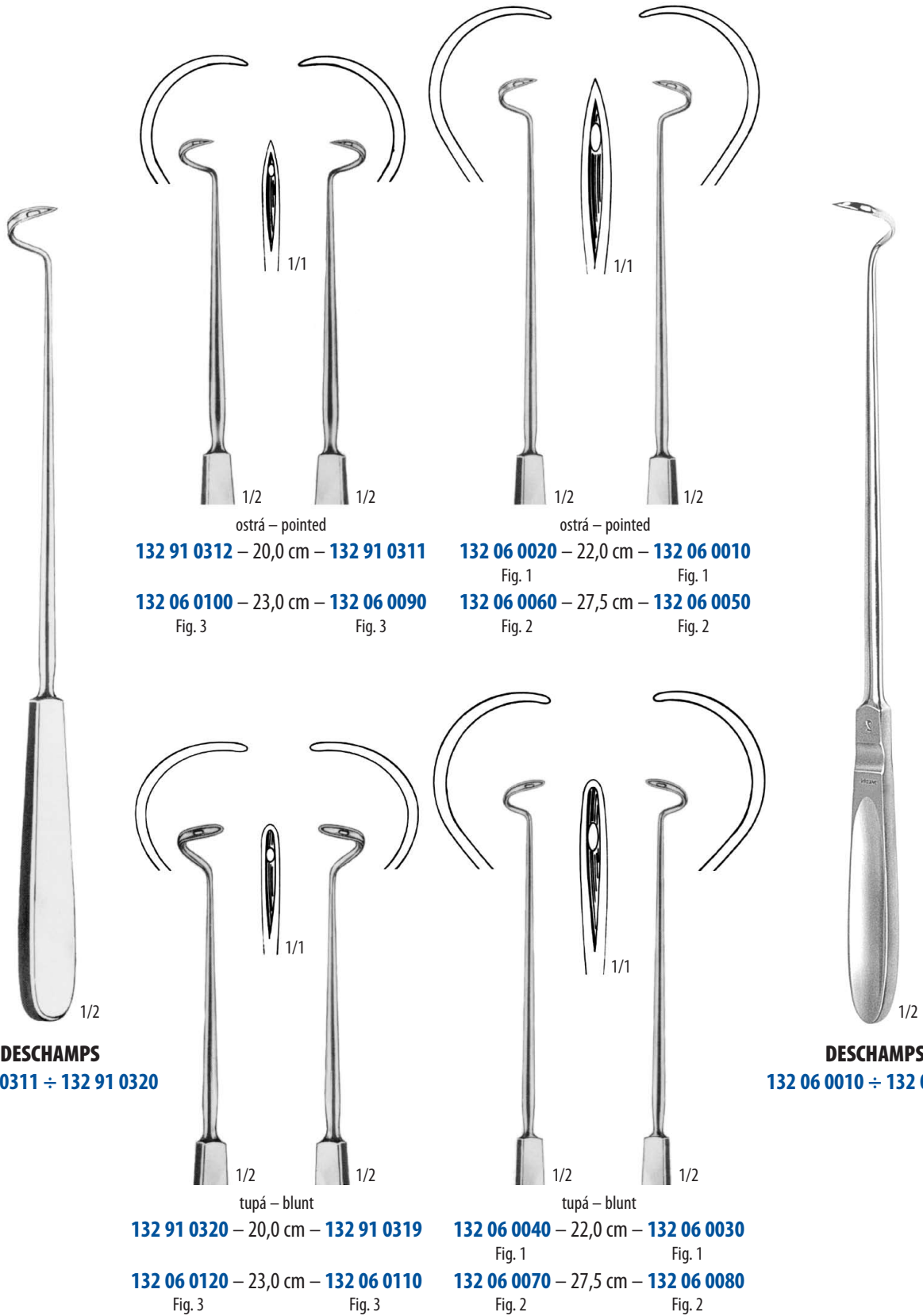

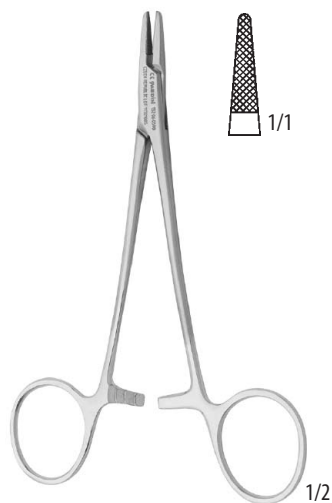
JEHELCE TVRDOKOVOVÉ
NEEDLE HOLDERS WITH TUNGSTEN CARBIDE INSERT

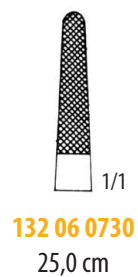
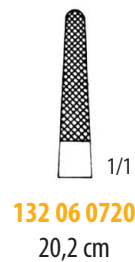
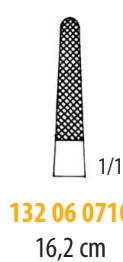
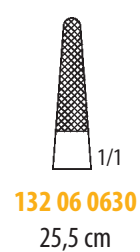
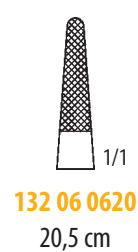
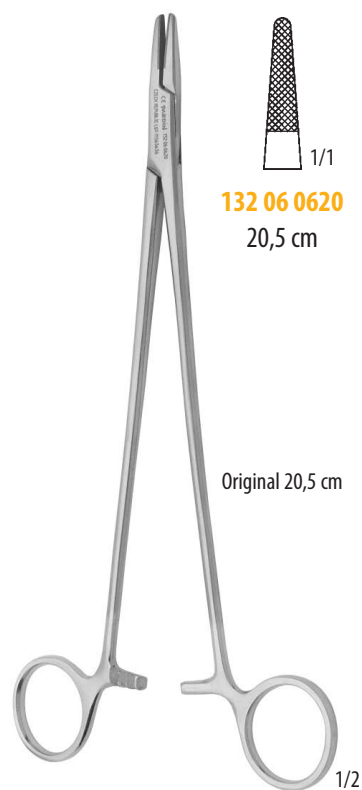
132 06 0590
 13,0 cm

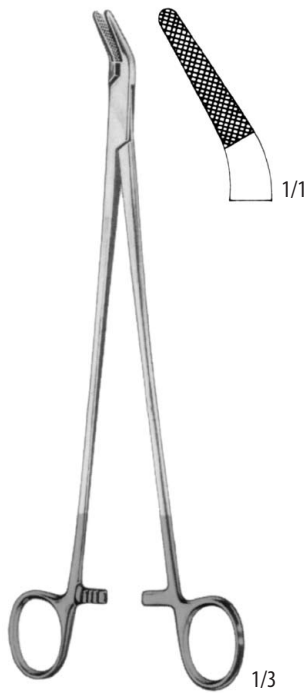
BOZEMANN

132 06 0610
 16,5 cm

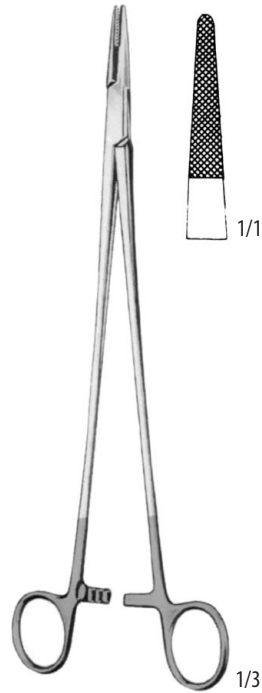

FINOCCHIETTO
132 91 0148

27,0 cm

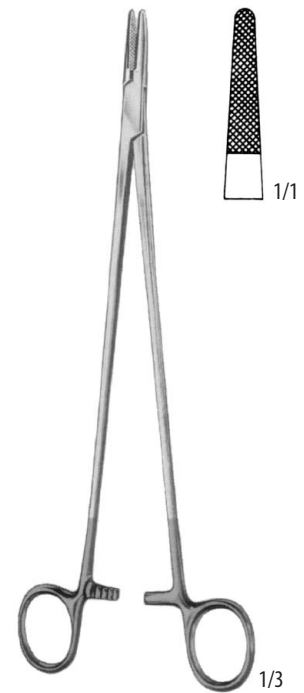
WANGENSTEEN
132 91 0149

27,0 cm

MASSON
132 91 0156

27,0 cm

SAROT

Original 18,0 cm

132 91 0154

18,0 cm

132 91 0155

26,0 cm

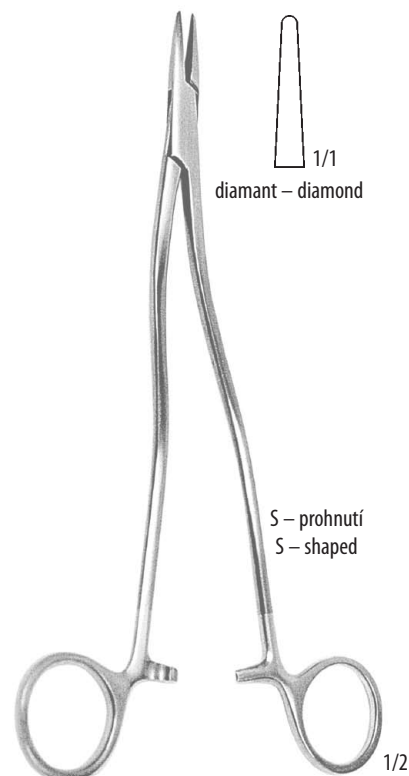
JEHELEC HLOUBKOVÝ
NEEDLE HOLDER
132 06 0740

20,2 cm

 1/1
 diamant – diamond

 S – prohnutí
 S – shaped

JEHELCE TVRDOKOVOVÉ
NEEDLE HOLDERS WITH TUNGSTEN CARBIDE INSERT







Original 19,0 cm

- 
 1/1
132 91 0160
 14,0 cm
- 
 1/1
132 91 0161
 17,0 cm
- 
 1/1
132 91 0162
 19,0 cm

OLSEN-HEGAR





Original 21,5 cm

- 
 1/1
132 06 0520
 14,0 cm
- 
 1/1
132 06 0500
 17,2 cm
- 
 1/1
132 06 0510
 21,5 cm
- 
 1/1
132 91 0167
 24,0 cm

MATHIEU



Original 20,0 cm

- 
 1/1
132 91 0168
 17,0 cm
- 
 1/1
132 91 0169
 20,0 cm
- 
 1/1
132 91 0170
 23,0 cm

MATHIEU

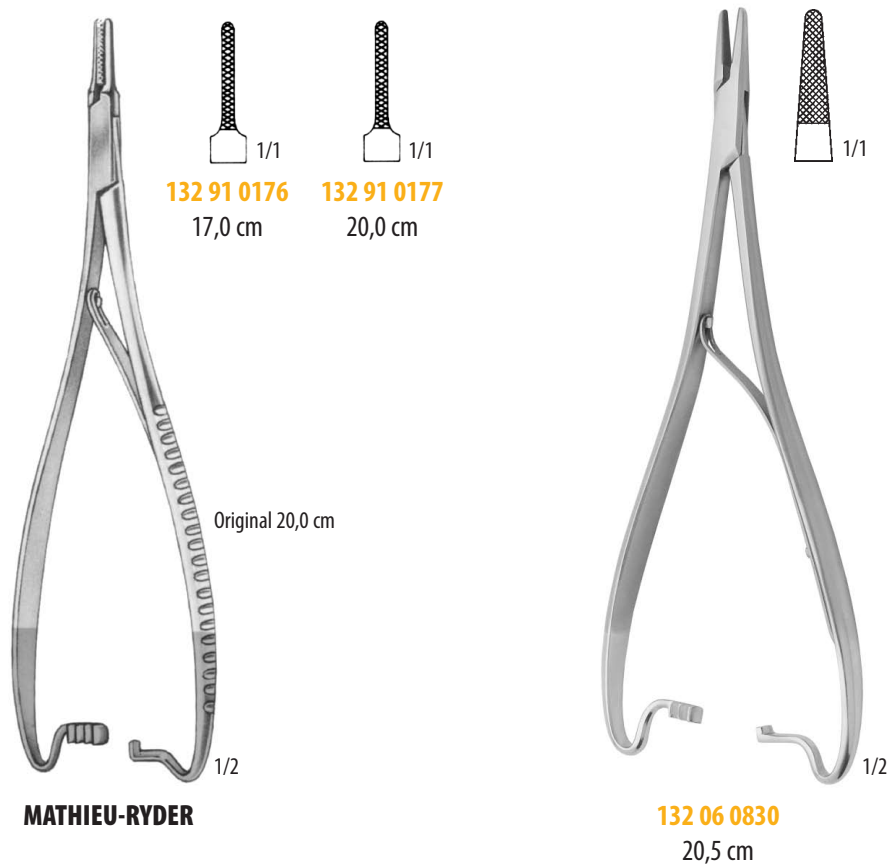
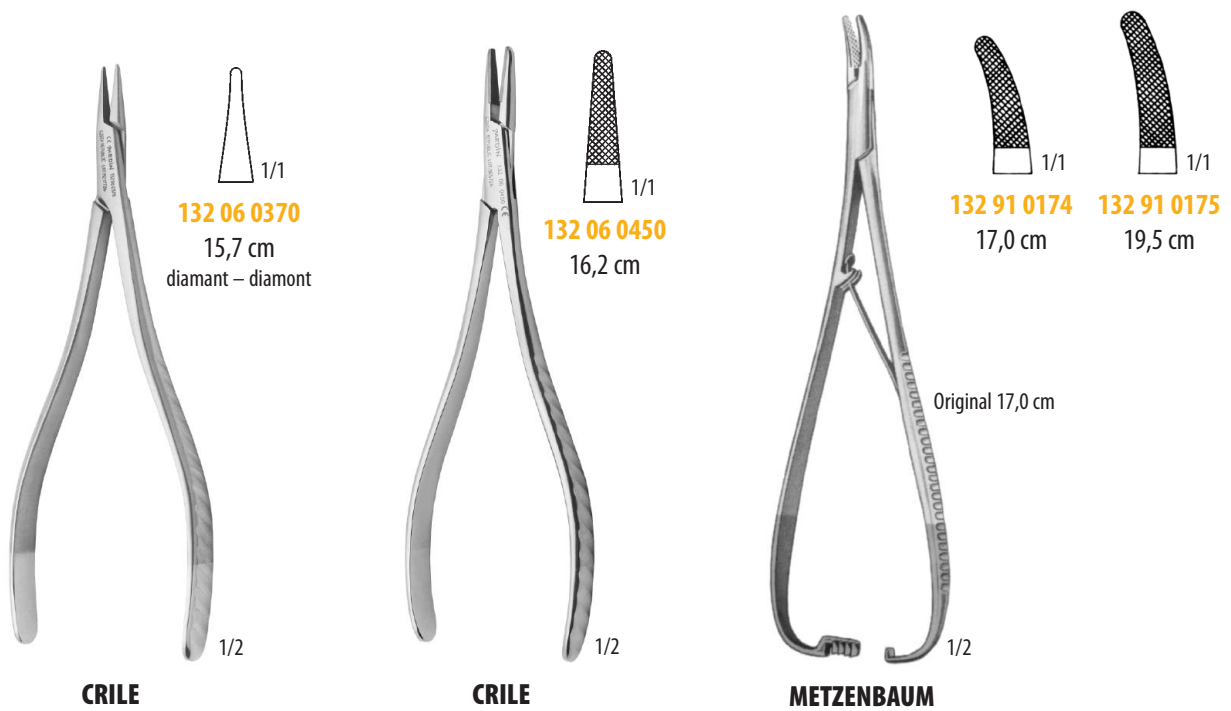

JEHELCE TVRDOKOVOVÉ
NEEDLE HOLDERS WITH TUNGSTEN CARBIDE INSERT



BOYNTON
132 91 0182
12,0 cm



LUETHY-BECK
132 91 0192
20,0 cm



HÖSEL
132 91 0186
25,0 cm



LANGENBECK



LANGENBECK
132 91 0194
18,0 cm



LANGENBECK
132 91 0195
20,0 cm



LANGENBECK-DELICATE
132 91 0196
18,0 cm



LANGENBECK-DELICATE
132 91 0197
20,0 cm



LANGENBECK-RYDER
132 91 0199
18,0 cm



LANGENBECK-RYDER
132 91 0200
20,0 cm



1/1



1/1

132 08 0500

16,0 cm
8 Ch



1/1

132 08 0510

16,0 cm
9 Ch

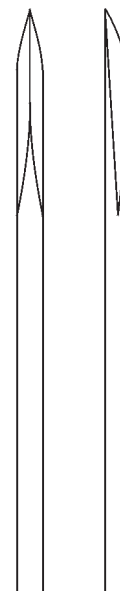

1/1

132 08 0520

16,0 cm
10 Ch

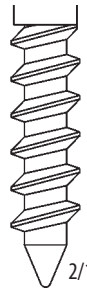

2/1



2/1



2/1



1/2

SIMS**133 91 0151**

32,0 cm

neohebná – rigid

SIMS**133 91 0152**

32,0 cm

ohebná – malleable



1/2

SIMS-SPECIAL**133 91 0153**

32,0 cm



1/2

SIMS SWED. MODEL**133 91 0154**

26,0 cm



1/2

MARTIN**133 91 0155**

30,0 cm



1/2

VALLEIX**133 91 0156**

25,0 cm

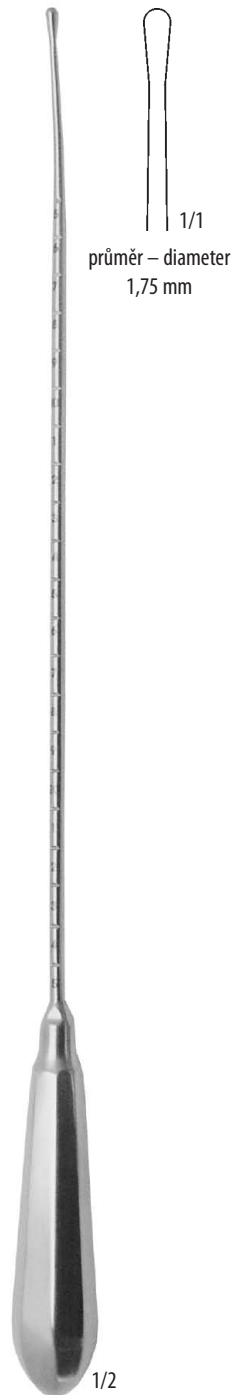

SIMS
133 27 0011
36,5 cm

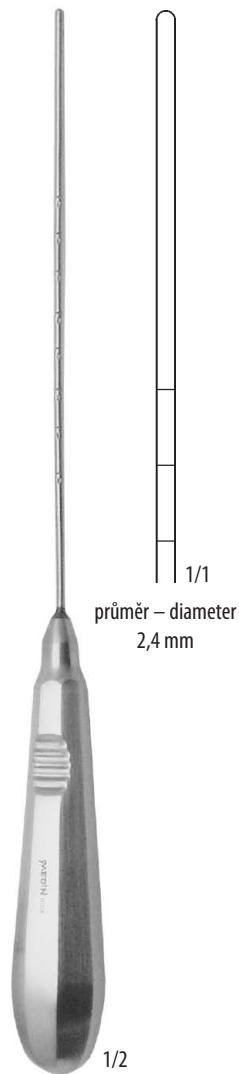

133 27 0130
28,0 cm



133 91 0150
31,0 cm
průměr – diameter
3,0 mm



1/2

HEGAR
ostrý – sharp
21,0 cm

ostrý – sharp	průměr – diameter
135 27 0400	1,0 mm
135 27 0410	1,5 mm
135 27 0010	2,0 mm
135 27 0020	2,5 mm
135 27 0030	3,0 mm
135 27 0040	3,5 mm
135 27 0050	4,0 mm
135 27 0060	4,5 mm
135 27 0070	5,0 mm
135 27 0080	5,0 mm
135 27 0090	6,0 mm
135 27 0100	6,5 mm
135 27 0110	7,0 mm
135 27 0120	7,5 mm
135 27 0130	8,0 mm
135 27 0140	8,5 mm



1/2

HEGAR
tupý – blunt
21,0 cm

tupý – blunt	průměr – diameter
135 27 0401	1,0 mm
135 27 0411	1,5 mm
135 27 0011	2,0 mm
135 27 0021	2,5 mm
135 27 0031	3,0 mm
135 27 0041	3,5 mm
135 27 0051	4,0 mm
135 27 0061	4,5 mm
135 27 0071	5,0 mm
135 27 0081	5,5 mm
135 27 0091	6,0 mm
135 27 0101	6,5 mm
135 27 0111	7,0 mm
135 27 0121	7,5 mm
135 27 0131	8,0 mm
135 27 0141	8,5 mm
135 91 0017	9,0 mm
135 91 0018	9,5 mm
135 91 0019	10,0 mm
135 91 0020	10,5 mm
135 91 0021	11,0 mm
135 91 0022	11,5 mm
135 91 0023	12,0 mm
135 91 0024	12,5 mm
135 91 0025	13,0 mm
135 91 0026	13,5 mm
135 91 0027	14,0 mm
135 91 0028	14,5 mm
135 91 0029	15,0 mm
135 91 0030	15,5 mm
135 91 0031	16,0 mm
135 91 0032	16,5 mm
135 91 0033	17,0 mm
135 91 0034	17,5 mm
135 91 0035	18,0 mm
135 91 0036	18,5 mm
135 91 0037	19,0 mm
135 91 0038	19,5 mm
135 91 0039	20,0 mm
135 91 0040	21,0 mm
135 91 0041	22,0 mm
135 91 0042	23,0 mm
135 91 0043	24,0 mm
135 91 0044	25,0 mm
135 91 0045	26,0 mm
135 91 0046	27,0 mm
135 91 0047	28,0 mm
135 91 0048	29,0 mm
135 91 0049	30,0 mm

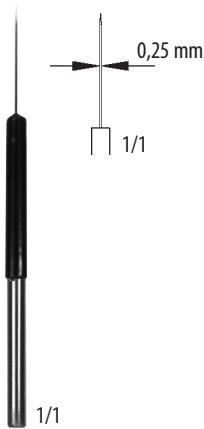

136 08 0510
5,5 cm
průměr dřívku – shank diameter
2,4 mm

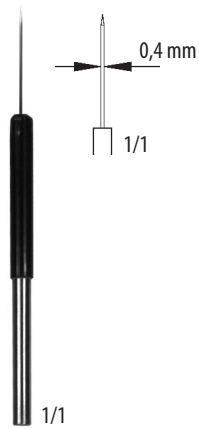

136 08 0520
5,5 cm
průměr dřívku – shank diameter
2,4 mm

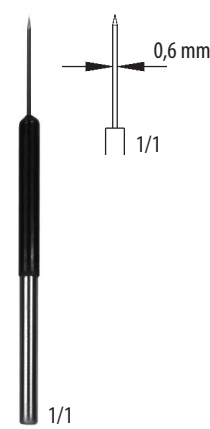

136 08 0530
5,5 cm
průměr dřívku – shank diameter
2,4 mm

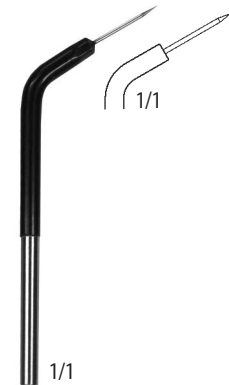

136 08 0540
5,0 cm
průměr dřívku – shank diameter
2,4 mm

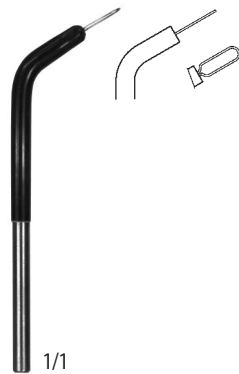

136 08 0550
4,7 cm
průměr dřívku – shank diameter
2,4 mm



136 08 0560
4,7 cm
průměr dřívku – shank diameter
2,4 mm



136 08 0570
4,7 cm
průměr dřívku – shank diameter
2,4 mm



136 08 0580
4,2 cm
průměr dřívku – shank diameter
2,4 mm

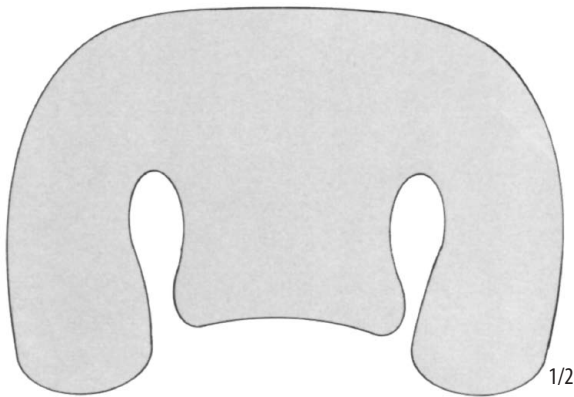

136 08 0590
4,4 cm
průměr dřívku – shank diameter
2,4 mm

NÁSTROJE PRO MIKROGYNEKOLOGII
INSTRUMENTS FOR MICRO-GYNAECOLOGY

DLAHA OCHRANNÁ PLASTOVÁ
PLASTIC PROTECTION PLATE
136 91 0004

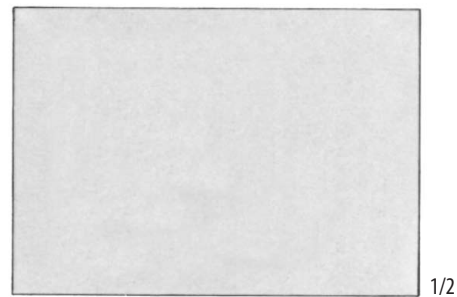

MATERIÁL PRO PLASTOVÉ DLAHY
PLASTIC TUBAL-SPLINT MATERIAL
136 91 0005

NÁSTROJE NA PLODOVÝ VAK
INSTRUMENTS FOR THE AMNIOM BLADDER

IOWA
TRUBIČKA
TUBE
136 91 0027
14,0 cm



16,0 cm	A	20,0 cm
136 91 0006	1,0 mm	136 91 0015
136 91 0007	1,5 mm	136 91 0016
136 91 0008	2,0 mm	136 91 0017
136 91 0009	2,5 mm	136 91 0018
136 91 0010	3,0 mm	136 91 0019
136 91 0011	3,5 mm	136 91 0020
136 91 0012	4,0 mm	136 91 0021
136 91 0013	4,5 mm	136 91 0022
136 91 0014	5,0 mm	136 91 0023

TYČINKY RETRAKČNÍ ATRAUM. INERTNÍ
ATRAUM. INERT. RETRACTING RODS

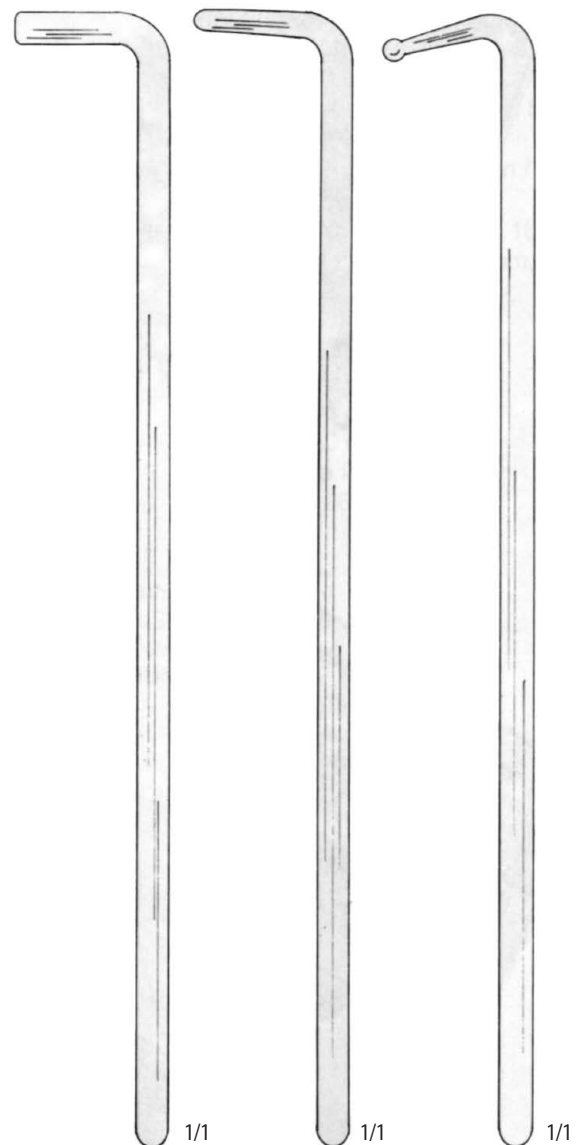

SONDY SKLENĚNÉ
GLASS PROBES
136 91 0024
sada – set
15,0 cm



136 91 0028	20,0 × 14,0 × 50 cm
136 91 0029	28,0 × 19,5 × 50 cm
136 91 0030	26,5 × 25,5 × 50 cm
136 91 0031	38,0 × 26,0 × 50 cm



136 91 0032	20,0 × 14,0 × 65 cm
136 91 0033	28,0 × 19,5 × 65 cm
136 91 0034	26,5 × 25,5 × 65 cm
136 91 0035	38,0 × 26,0 × 65 cm

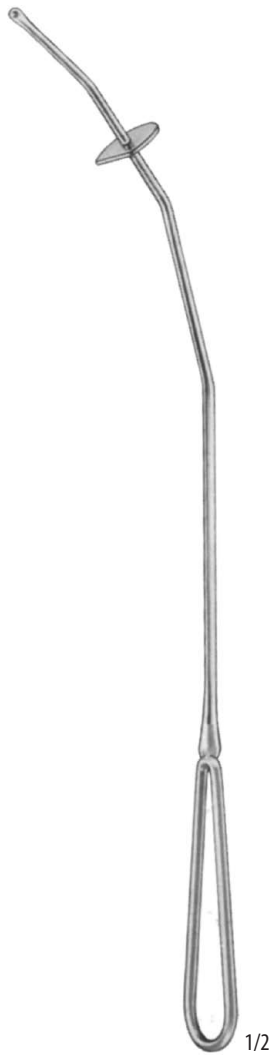

RAMATHIBODI
MANIPULÁTOR DĚLOŽNÍ
UTERINE MANIPULATOR
136 91 0025
27,5 cm



RAMATHIBODI
HÁK
TUBAL HOOK
136 91 0026
25,0 cm

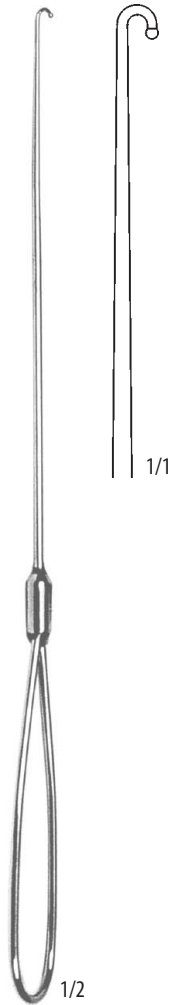

136 27 0310
26,5 cm

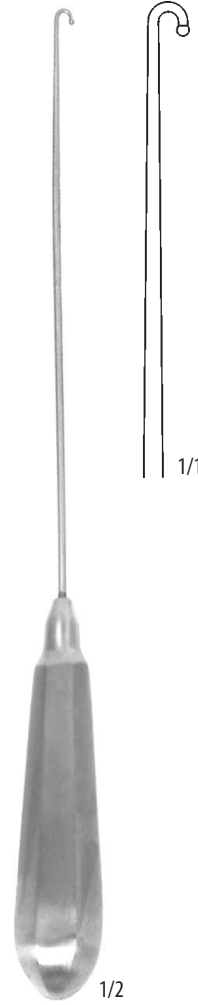

136 27 0311
26,5 cm

číslo – number	název	item	strana – page
111	DIAGNOSTIKA	DIAGNOSTIC	
111 91 0092	Schultze salpingograf komplet	Schultze salpingograph set	9
111 91 0093	Martin pelvimetr; 34,0 cm	Martin pelvimeter; 34,0 cm	10
111 91 0110	Měřitko odstupňované; 18,0 cm	Measuring instrument; 18,0 cm	10
111 91 0161	Manometr k salpingografu	Manometer for salpingograph	9
111 91 0162	Stříkačka k salpingografu	Syringe for salpingograph	9
111 91 0163	Kužel k salpingografu malý	Cone for salpingograph small	9
111 91 0164	Kužel k salpingografu střední	Cone for salpingograph middle	9
111 91 0165	Kužel k salpingografu velký	Cone for salpingograph large	9
111 91 0166	Katetr k salpingografu	Tubal catheter	9
112	NÁSTROJE ŘEZNÉ	CUTTING INSTRUMENTS	
112 27 0040	Skalpel s hranatým držadlem; 21,8 cm	Operating knife for gynaecology; 21,8 cm	11
112 27 0050	Skalpel s hranatým držadlem bříškatý; 21,1 cm	Operating knife for gynaecology; 21,1 cm	11
112 27 0060	Skalpel s hranatým držadlem hrotnatý; 21,5 cm	Operating knife for gynaecology; 21,5 cm	11
112 27 0250	Segond nůž na myomy dvojbřítý; 22,3 cm	Segond myomy knife; 22,3 cm	11
113	NŮŽKY	SCISSORS	
113 08 0010	Nůžky chirurgické rovné hrotnaté; 13,0 cm	Standard operating scissors; 13,0 cm	12
113 08 0020	Nůžky chirurgické rovné hrotnaté; 15,0 cm	Standard operating scissors; 15,0 cm	12
113 08 0040	Nůžky chirurgické rovné hrotnaté; 18,5 cm	Standard operating scissors; 18,5 cm	12
113 08 0060	Nůžky chirurgické rovné hrotnaté; 22,0 cm	Standard operating scissors; 22,0 cm	12
113 08 0070	Nůžky chirurgické rovné hrotnaté; 30,0 cm	Standard operating scissors; 30,0 cm	12
113 08 0110	Nůžky chirurgické rovné hrotnatotupé; 13,0 cm	Standard operating scissors; 13,0 cm	13
113 08 0120	Nůžky chirurgické rovné hrotnatotupé; 15,0 cm	Standard operating scissors; 15,0 cm	13
113 08 0140	Nůžky chirurgické rovné hrotnatotupé; 18,5 cm	Standard operating scissors; 18,5 cm	13
113 08 0160	Nůžky chirurgické rovné hrotnatotupé; 22,0 cm	Standard operating scissors; 22,0 cm	13
113 08 0170	Nůžky chirurgické rovné hrotnatotupé; 30,0 cm	Standard operating scissors; 30,0 cm	13
113 08 0210	Nůžky chirurgické rovné tupé; 13,0 cm	Standard operating scissors; 13,0 cm	13
113 08 0220	Nůžky chirurgické rovné tupé; 15,0 cm	Standard operating scissors; 15,0 cm	13
113 08 0240	Nůžky chirurgické rovné tupé; 18,5 cm	Standard operating scissors; 18,5 cm	13
113 08 0260	Nůžky chirurgické rovné tupé; 22,0 cm	Standard operating scissors; 22,0 cm	13
113 08 0270	Nůžky chirurgické rovné tupé; 30,0 cm	Standard operating scissors; 30,0 cm	13
113 08 0310	Nůžky chirurgické zahnuté hrotnaté; 13,0 cm	Standard operating scissors; 13,0 cm	12
113 08 0320	Nůžky chirurgické zahnuté hrotnaté; 15,0 cm	Standard operating scissors; 15,0 cm	12
113 08 0340	Nůžky chirurgické zahnuté hrotnaté; 18,5 cm	Standard operating scissors; 18,5 cm	12
113 08 0360	Nůžky chirurgické zahnuté hrotnaté; 22,0 cm	Standard operating scissors; 22,0 cm	12
113 08 0370	Nůžky chirurgické zahnuté hrotnaté; 30,0 cm	Standard operating scissors; 30,0 cm	12
113 08 0410	Nůžky chirurgické zahnuté hrotnatotupé; 13,0 cm	Standard operating scissors; 13,0 cm	13
113 08 0420	Nůžky chirurgické zahnuté hrotnatotupé; 15,0 cm	Standard operating scissors; 15,0 cm	13
113 08 0440	Nůžky chirurgické zahnuté hrotnatotupé; 18,5 cm	Standard operating scissors; 18,5 cm	13
113 08 0460	Nůžky chirurgické zahnuté hrotnatotupé; 22,0 cm	Standard operating scissors; 22,0 cm	13
113 08 0470	Nůžky chirurgické zahnuté hrotnatotupé; 30,0 cm	Standard operating scissors; 30,0 cm	13
113 08 0510	Nůžky chirurgické zahnuté tupé; 13,0 cm	Standard operating scissors; 13,0 cm	13
113 08 0520	Nůžky chirurgické zahnuté tupé; 15,0 cm	Standard operating scissors; 15,0 cm	13
113 08 0540	Nůžky chirurgické zahnuté tupé; 18,5 cm	Standard operating scissors; 18,5 cm	13
113 08 0560	Nůžky chirurgické zahnuté tupé; 22,0 cm	Standard operating scissors; 22,0 cm	13
113 08 0570	Nůžky chirurgické zahnuté tupé; 30,0 cm	Standard operating scissors; 30,0 cm	13
113 08 0700	Metzenbaum nůžky preparační zahnuté; 14,0 cm	Metzenbaum dissecting scissors; 14,0 cm	17
113 08 0830	Mayo nůžky preparační rovné extra silné; 17,0 cm	Mayo dissecting scissors; 17,0 cm	18
113 08 0840	Mayo nůžky preparační zahnuté extra silné; 17,0 cm	Mayo dissecting scissors; 16,8 cm	18
113 08 0880	Nůžky preparační rovné jemné; 18,5 cm	Dissecting scissors; 18,5 cm	19
113 08 0890	Nůžky preparační zahnuté jemné; 18,5 cm	Dissecting scissors; 18,5 cm	19
113 08 0930	Nůžky preparační rovné; 17,0 cm	Dissecting scissors; 17,0 cm	19
113 08 0940	Nůžky preparační zahnuté; 17,0 cm	Dissecting scissors; 17,0 cm	19
113 10 0110	Nůžky preparační dětské tupé rovné; 18,5 cm	Dissecting scissors; 18,5 cm	20
113 10 0120	Nůžky preparační dětské tupé zahnuté; 18,5 cm	Dissecting scissors; 18,5 cm	20
113 10 0210	Nůžky preparační tupé rovné jemné; 18,5 cm	Dissecting scissors; 18,5 cm	20
113 10 0220	Nůžky preparační tupé zahnuté jemné; 18,5 cm	Dissecting scissors; 18,5 cm	20
113 12 0010	Nůžky preparační s oboustranným ostřím rovné; 12,0 cm	Dissecting scissors; 12,0 cm	21
113 12 0020	Nůžky preparační s oboustranným ostřím zahnuté; 12,0 cm	Dissecting scissors; 12,0 cm	21
113 27 0010	Siebolt nůžky děložní; 24,0 cm	Siebolt uterine scissors; 24,0 cm	13
113 38 0010	Nůžky oční rovné hrotnaté; 10,0 cm	Eye scissors; 10,0 cm	22
113 38 0020	Nůžky oční rovné hrotnatotupé; 10,0 cm	Eye scissors; 10,0 cm	22
113 38 0030	Nůžky oční rovné tupé; 10,0 cm	Eye scissors; 10,0 cm	22

číslo – number	název	item	strana – page
113 38 0040	Nůžky oční zahnuté hrotnaté; 10,0 cm	Eye scissors; 10,0 cm	22
113 38 0050	Nůžky oční zahnuté hrotnatotupé; 10,0 cm	Eye scissors; 10,0 cm	22
113 38 0060	Nůžky oční zahnuté tupé; 10,0 cm	Eye scissors; 10,0 cm	22
113 38 0071	Nůžky oční rovné hrotnaté; 11,5 cm	Eye scissors; 11,5 cm	22
113 38 0081	Nůžky oční rovné tupé; 11,5 cm	Eye scissors; 11,5 cm	22
113 38 0091	Nůžky oční zahnuté hrotnaté; 11,5 cm	Eye scissors; 11,5 cm	22
113 38 0100	Nůžky oční zahnuté hrotnatotupé; 11,5 cm	Eye scissors; 11,5 cm	22
113 38 0150	Nůžky oční rovné hrotnatotupé; 11,5 cm	Eye scissors; 11,5 cm	22
113 38 0161	Nůžky oční zahnuté tupé; 11,5 cm	Eye scissors; 11,5 cm	22
113 38 0210	Nůžky oční lomené hrotnaté; 10,5 cm	Eye scissors; 10,5 cm	22
113 38 0260	Nůžky oční lomené tupé; 10,5 cm	Eye scissors; 10,5 cm	22
113 38 0311	Nůžky oční stranou zahnuté hrotnaté; 11,5 cm	Eye scissors; 11,5 cm	22
113 91 0002	Nůžky chirurgické tupé rovné; 11,5 cm	Standard operating scissors; 11,5 cm	13
113 91 0006	Nůžky chirurgické tupé rovné; 16,5 cm	Standard operating scissors; 16,5 cm	13
113 91 0009	Nůžky chirurgické tupé rovné; 20,0 cm	Standard operating scissors; 20,0 cm	13
113 91 0011	Nůžky chirurgické tupé zahnuté; 11,5 cm	Standard operating scissors; 11,5 cm	13
113 91 0015	Nůžky chirurgické tupé zahnuté; 16,5 cm	Standard operating scissors; 16,5 cm	13
113 91 0018	Nůžky chirurgické tupé zahnuté; 20,0 cm	Standard operating scissors; 20,0 cm	13
113 91 0020	Nůžky chirurgické hrotnatotupé rovné; 11,5 cm	Standard operating scissors; 11,5 cm	13
113 91 0026	Nůžky chirurgické hrotnatotupé rovné; 16,5 cm	Standard operating scissors; 16,5 cm	13
113 91 0029	Nůžky chirurgické hrotnatotupé rovné; 20,0 cm	Standard operating scissors; 20,0 cm	13
113 91 0031	Nůžky chirurgické hrotnatotupé zahnuté; 11,5 cm	Standard operating scissors; 11,5 cm	13
113 91 0037	Nůžky chirurgické hrotnatotupé zahnuté; 16,5 cm	Standard operating scissors; 16,5 cm	13
113 91 0040	Nůžky chirurgické hrotnatotupé zahnuté; 20,0 cm	Standard operating scissors; 20,0 cm	13
113 91 0042	Nůžky chirurgické hrotnaté rovné; 11,5 cm	Standard operating scissors; 11,5 cm	12
113 91 0046	Nůžky chirurgické hrotnaté rovné; 16,5 cm	Standard operating scissors; 16,5 cm	12
113 91 0049	Nůžky chirurgické hrotnaté rovné; 20,0 cm	Standard operating scissors; 20,0 cm	12
113 91 0051	Nůžky chirurgické hrotnaté zahnuté; 11,5 cm	Standard operating scissors; 11,5 cm	12
113 91 0055	Nůžky chirurgické hrotnaté zahnuté; 16,5 cm	Standard operating scissors; 16,5 cm	12
113 91 0058	Nůžky chirurgické hrotnaté zahnuté; 20,0 cm	Standard operating scissors; 20,0 cm	12
113 91 0075	Fergusson nůžky chirurgické; 16,5 cm	Fergusson operating scissors; 16,5 cm	12
113 91 0076	Fergusson nůžky chirurgické; 18,0 cm	Fergusson operating scissors; 18,0 cm	12
113 91 0077	Deaver nůžky chirurgické hrotnatotupé rovné; 14,0 cm	Deaver operating scissors; 14,0 cm	12
113 91 0078	Deaver nůžky chirurgické hrotnatotupé zahnuté; 14,0 cm	Deaver operating scissors; 14,0 cm	12
113 91 0083	Mayo nůžky preparační tupé rovné; 14,5 cm	Mayo dissecting scissors; 14,5 cm	18
113 91 0087	Mayo nůžky preparační tupé rovné; 23,0 cm	Mayo dissecting scissors; 23,0 cm	18
113 91 0090	Mayo nůžky preparační tupé zahnuté; 14,5 cm	Mayo dissecting scissors; 14,5 cm	18
113 91 0094	Mayo nůžky preparační tupé zahnuté; 23,0 cm	Mayo dissecting scissors; 23,0 cm	18
113 91 0097	Mayo-Stille nůžky preparační tupé rovné; 15,0 cm	Mayo-Stille dissecting scissors; 15,0 cm	18
113 91 0098	Mayo-Stille nůžky preparační tupé rovné; 17,0 cm	Mayo-Stille dissecting scissors; 17,0 cm	18
113 91 0101	Mayo-Stille nůžky preparační tupé zahnuté; 15,0 cm	Mayo-Stille dissecting scissors; 15,0 cm	18
113 91 0102	Mayo-Stille nůžky preparační tupé zahnuté; 17,0 cm	Mayo-Stille dissecting scissors; 17,0 cm	18
113 91 0110	Kelly nůžky na fistuli rovné; 16,0 cm	Kelly fistula scissors; 16,0 cm	12
113 91 0112	Kelly nůžky na fistuli zahnuté; 16,0 cm	Kelly fistula scissors; 16,0 cm	12
113 91 0117	Sims nůžky gynekologické tupé rovné; 20,0 cm	Sims gynaecological scissors; 20,0 cm	12
113 91 0118	Sims nůžky gynekologické tupé rovné; 23,0 cm	Sims gynaecological scissors; 23,0 cm	12
113 91 0119	Sims nůžky gynekologické tupé zahnuté; 20,0 cm	Sims gynaecological scissors; 20,0 cm	12
113 91 0120	Sims nůžky gynekologické tupé zahnuté; 23,0 cm	Sims gynaecological scissors; 23,0 cm	12
113 91 0121	Sims nůžky gynekologické hrotnato-tupé; 20,0 cm	Sims gynaecological scissors; 20,0 cm	12
113 91 0122	Sims nůžky gynekologické hrotnato-tupé; 23,0 cm	Sims gynaecological scissors; 23,0 cm	12
113 91 0123	Sims nůžky gynekologické hrotnato-tupé; 20,0 cm	Sims gynaecological scissors; 20,0 cm	12
113 91 0124	Sims nůžky gynekologické hrotnato-tupé; 23,0 cm	Sims gynaecological scissors; 23,0 cm	12
113 91 0125	Sims nůžky gynekologické hrotnaté rovné; 20,0 cm	Sims gynaecological scissors; 20,0 cm	12
113 91 0126	Sims nůžky gynekologické hrotnaté rovné; 23,0 cm	Sims gynaecological scissors; 23,0 cm	12
113 91 0127	Sims nůžky gynekologické hrotnaté zahnuté; 20 cm	Sims gynaecological scissors; 20,0 cm	12
113 91 0128	Sims nůžky gynekologické hrotnaté zahnuté; 23 cm	Sims gynaecological scissors; 23,0 cm	12
113 91 0129	Dubois nůžky gynekologické tupé rovné; 27,0 cm	Dubois cephalotomy scissors; 27,0 cm	13
113 91 0130	Dubois nůžky gynekologické tupé zahnuté; 27,0 cm	Dubois cephalotomy scissors; 27,0 cm	13
113 91 0143	Metzenbaum-Nelson nůžky preparační tupé rovné; 18,0 cm	Metzenbaum-Nelson dissecting scissors; 18,0 cm	17
113 91 0145	Metzenbaum-Nelson nůžky preparační tupé rovné; 20,0 cm	Metzenbaum-Nelson dissecting scissors; 20,0 cm	17
113 91 0147	Metzenbaum-Nelson nůžky preparační tupé rovné; 23,0 cm	Metzenbaum-Nelson dissecting scissors; 23,0 cm	17
113 91 0149	Metzenbaum-Nelson nůžky preparační tupé rovné; 25,0 cm	Metzenbaum-Nelson dissecting scissors; 25,0 cm	17
113 91 0150	Metzenbaum-Nelson nůžky preparační tupé rovné; 28,0 cm	Metzenbaum-Nelson dissecting scissors; 18,0 cm	17
113 91 0152	Metzenbaum-Nelson nůžky preparační rovné jemné; 18,0 cm	Metzenbaum-Nelson dissecting scissors; 18,0 cm	17
113 91 0154	Metzenbaum-Nelson nůžky preparační tupé zahnuté; 20,0 cm	Metzenbaum-Nelson dissecting scissors; 20,0 cm	17
113 91 0156	Metzenbaum-Nelson nůžky preparační tupé zahnuté; 23,0 cm	Metzenbaum-Nelson dissecting scissors; 23,0 cm	17
113 91 0158	Metzenbaum-Nelson nůžky preparační tupé zahnuté; 25,0 cm	Metzenbaum-Nelson dissecting scissors; 25,0 cm	17
113 91 0159	Metzenbaum-Nelson nůžky preparační tupé zahnuté; 28,0 cm	Metzenbaum-Nelson dissecting scissors; 18,0 cm	17
113 91 0189	Metzenbaum-Delicate nůžky preparační tupé rovné; 18,0 cm	Metzenbaum-Delicate scissors; 18,0 cm	17
113 91 0190	Metzenbaum-Delicate nůžky preparační tupé rovné; 20,0 cm	Metzenbaum-Delicate scissors; 20,0 cm	17

číslo – number	název	item	strana – page
113 91 0191	Metzenbaum-Delicate nůžky preparační tupé rovné; 23,0 cm	Metzenbaum-Delicate scissors; 23,0 cm	17
113 91 0192	Metzenbaum-Delicate nůžky preparační tupé rovné; 25,0 cm	Metzenbaum-Delicate scissors; 25,0 cm	17
113 91 0195	Metzenbaum-Delicate nůžky preparační tupé zahnuté; 18,0 cm	Metzenbaum-Delicate scissors; 18,0 cm	17
113 91 0196	Metzenbaum-Delicate nůžky preparační tupé zahnuté; 20,0 cm	Metzenbaum-Delicate scissors; 20,0 cm	17
113 91 0197	Metzenbaum-Delicate nůžky preparační tupé zahnuté; 23,0 cm	Metzenbaum-Delicate scissors; 23,0 cm	17
113 91 0198	Metzenbaum-Delicate nůžky preparační tupé zahnuté; 25,0 cm	Metzenbaum-Delicate scissors; 25,0 cm	17
113 91 0215	Lexer nůžky preparační rovné; 16,0 cm	Lexer dissecting scissors; 16,0 cm	20
113 91 0216	Lexer nůžky preparační zahnuté; 16,0 cm	Lexer dissecting scissors; 16,0 cm	20
113 91 0217	Fomon nůžky preparační zahnuté; 13,5 cm	Fomon dissecting scissors; 13,5 cm	19
113 91 0218	Thorek nůžky preparační zahnuté; 19,0 cm	Thorek dissecting scissors; 19,0 cm	19
113 91 0219	Lexer-Baby nůžky preparační rovné; 10,0 cm	Lexer-Baby dissecting scissors; 10,0 cm	19
113 91 0220	Lexer-Baby nůžky preparační zahnuté; 10,0 cm	Lexer-Baby dissecting scissors; 10,0 cm	19
113 91 0221	Sanvenero nůžky preparační hrotnaté rovné; 14,0 cm	Sanvenero dissecting scissors; 14,0 cm	21
113 91 0222	Sanvenero nůžky preparační hrotnaté zahnuté; 14,0 cm	Sanvenero dissecting scissors; 14,0 cm	21
113 91 0229	Kilner nůžky preparační zahnuté; 12,0 cm	Kilner dissecting scissors; 12,0 cm	20
113 91 0230	Kilner nůžky preparační zahnuté; 15,0 cm	Kilner dissecting scissors; 15,0 cm	20
113 91 0233	Reynolds nůžky preparační ostré rovné; 15,0 cm	Reynolds dissecting scissors; 15,0 cm	21
113 91 0235	Reynolds nůžky preparační ostré zahnuté; 15,0 cm	Reynolds dissecting scissors; 15,0 cm	21
113 91 0317	Braun-Stadler nůžky pro episiotomii; 14,0 cm	Braun-Stadler episiotomy scissors; 14,0 cm	14
113 91 0318	Braun-Stadler nůžky pro episiotomii; 22,0 cm	Braun-Stadler episiotomy scissors; 22,0 cm	14
113 91 0319	Waldmann nůžky pro episiotomii; 18,0 cm	Waldmann episiotomy scissors; 18,0 cm	14
114	PINZETY	FORCEPS	
114 08 0090	Pinzeta anatomická rovná hladká; 14,5 cm	Dressing forceps; 14,5 cm	23
114 08 0140	Pinzeta anatomická jemná; 20,0 cm	Dressing forceps; 20,0 cm	23
114 08 0231	Pinzeta anatomická velmi jemná matovaná; 14,5 cm	Dressing forceps; 14,5 cm	23
114 08 0240	Pinzeta anatomická velmi jemná; 20,0 cm	Dressing forceps; 20,0 cm	23
114 08 0250	Pinzeta anatomická velmi jemná; 25,0 cm	Dressing forceps; 25,0 cm	23
114 08 1470	Pinzeta bipolární bajonetová; 1,2 mm; 25,0 cm	Bipolar forceps bay-shaped; 1,2 mm; 25,0 cm	24
114 08 1480	Pinzeta bipolární bajonetová; 0,7 mm; 25,0 cm	Bipolar forceps bay-shaped; 0,7 mm; 25,0 cm	24
114 08 1490	Pinzeta bipolární bajonetová; 2,0 mm; 25,0 cm	Bipolar forceps bay-shaped; 2,0 mm; 25,0 cm	24
114 08 1500	Pinzeta bipolární rovná; 2,0 mm; 19,5 cm	Bipolar forceps; 2,0 mm; 19,5 cm	24
114 08 1510	Pinzeta bipolární rovná; 1,2 mm; 19,5 cm	Bipolar forceps; 1,2 mm; 19,5 cm	24
114 08 1530	Pinzeta bipolární zahnutá; 2,0 mm; 19,3 cm	Bipolar forceps; 2,0 mm; 19,3 cm	24
114 08 1540	Pinzeta bipolární zahnutá; 1,2 mm; 19,3 cm	Bipolar forceps; 1,2 mm; 19,3 cm	24
114 08 1560	Pinzeta bipolární rovná; 2,0 mm; 16,5 cm	Bipolar forceps; 2,0 mm; 16,5 cm	24
114 08 1570	Pinzeta bipolární rovná; 1,2 mm; 16,5 cm	Bipolar forceps; 1,2 mm; 16,5 cm	24
114 08 1580	Pinzeta bipolární rovná; 0,7 mm; 16,5 cm	Bipolar forceps; 0,7 mm; 16,5 cm	24
114 08 1690	Pinzeta bipolární zahnutá; 2,0 mm; 16,3 cm	Bipolar forceps; 2,0 mm; 16,3 cm	24
114 08 1700	Pinzeta bipolární zahnutá; 1,2 mm; 16,3 cm	Bipolar forceps; 1,2 mm; 16,3 cm	24
114 08 1710	Pinzeta bipolární zahnutá; 0,7 mm; 16,3 cm	Bipolar forceps; 0,7 mm; 16,3 cm	24
114 08 1720	Pinzeta bipolární rovná; 0,7 mm; 11,5 cm	Bipolar forceps; 0,7 mm; 11,5 cm	24
114 08 1730	Pinzeta bipolární rovná; 0,4 mm; 11,5 cm	Bipolar forceps; 0,4 mm; 11,5 cm	24
114 08 1750	Pinzeta bipolární zahnutá; 0,7 mm; 11,5 cm	Bipolar forceps; 0,7 mm; 11,5 cm	24
114 08 1760	Pinzeta bipolární zahnutá; 0,4 mm; 11,5 cm	Bipolar forceps; 0,4 mm; 11,5 cm	24
115	SVORKY	CLAMPS, FORCEPS	
115 08 0010	Mosquito-Halsted svorka na cévy rovná; 12,0 cm	Mosquito-Halsted artery forceps; 12,0 cm	29
115 08 0020	Mosquito-Halsted svorka na cévy zahnutá; 12,0 cm	Mosquito-Halsted artery forceps; 12,0 cm	29
115 08 0030	Mosquito-Halsted svorka rovná 1×2 zuby; 12,0 cm	Mosquito-Halsted artery forceps 1×2 teeth; 12,0 cm	29
115 08 0040	Mosquito-Halsted svorka rovná hladká 12,0 cm	Mosquito-Halsted artery forceps; 12,0 cm	29
115 08 0050	Mosquito-Halsted svorka zahnutá 1×2 zuby; 12 cm	Mosquito-Halsted artery forceps 1×2 teeth; 12,0 cm	29
115 08 0060	Mosquito-Halsted svorka zahnutá hladká; 12,0 cm	Mosquito-Halsted artery forceps; 12,0 cm	29
115 08 0071	Pean svorka na cévy rovná; 17,5 cm	Pean artery forceps; 17,5 cm	28
115 08 0121	Rochester-Pean svorka na cévy rovná; 20,0 cm	Rochester-Pean artery forceps; 20,0 cm	34
115 08 0130	Rochester-Pean svorka na cévy rovná; 24,0 cm	Rochester-Pean artery forceps; 24,0 cm	34
115 08 0171	Rochester-Pean svorka na cévy zahnutá; 20,0 cm	Rochester-Pean artery forceps; 20,0 cm	35
115 08 0180	Rochester-Pean svorka na cévy zahnutá; 24,0 cm	Rochester-Pean artery forceps; 24,0 cm	35
115 08 0190	Pean svorka na cévy rovná jemná; 20,0 cm	Pean artery forceps; 20,0 cm	31
115 08 0200	Pean svorka na cévy zahnutá jemná; 20,0 cm	Pean artery forceps; 20,0 cm	31
115 08 0220	Rochester-Pean svorka na cévy rovná; 14,0 cm	Rochester-Pean artery forceps; 14,0 cm	34
115 08 0231	Rochester-Pean svorka na cévy rovná; 16,0 cm	Rochester-Pean artery forceps; 16,0 cm	34
115 08 0260	Rochester-Pean svorka na cévy zahnutá; 14,0 cm	Rochester-Pean artery forceps; 14,0 cm	35
115 08 0271	Rochester-Pean svorka na cévy zahnutá; 16,0 cm	Rochester-Pean artery forceps; 16,0 cm	35
115 08 0331	Kocher svorka na cévy rovná; 20,0 cm	Kocher artery forceps; 20,0 cm	32
115 08 0340	Kocher svorka na cévy rovná; 24,0 cm	Kocher artery forceps; 24,0 cm	32
115 08 0381	Kocher svorka na cévy zahnutá; 20,0 cm	Kocher artery forceps; 20,0 cm	32
115 08 0390	Kocher svorka na cévy zahnutá; 24,0 cm	Kocher artery forceps; 24,0 cm	32
115 08 0410	Kocher svorka na cévy rovná jemná; 20,0 cm	Kocher artery forceps; 20,0 cm	31
115 08 0420	Kocher svorka na cévy zahnutá jemná; 20,0 cm	Kocher artery forceps; 20,0 cm	31
115 08 0500	Kelly svorka na cévy zahnutá; 14,0 cm	Kelly artery forceps; 14,0 cm	33
115 08 0520	Kelly svorka na cévy zahnutá jemná; 22,5 cm	Kelly artery forceps; 22,5 cm	33

číslo – number	název	item	strana – page
115 08 0550	Rochester-Ochsner svorka na cévy rovná; 14 cm	Rochester-Ochsner artery forceps; 14,0 cm	32
115 08 0561	Rochester-Ochsner svorka na cévy rovná; 16 cm	Rochester-Ochsner artery forceps; 16,0 cm	32
115 08 0590	Rochester-Ochsner svorka na cévy zahnutá; 14 cm	Rochester-Ochsner artery forceps; 14,0 cm	32
115 08 0601	Rochester-Ochsner svorka na cévy zahnutá; 16 cm	Rochester-Ochsner artery forceps; 16,0 cm	32
115 08 0780	Backhaus svorka s kuličkou; 11,8 cm	Backhaus towel forceps; 11,8 cm	60
115 08 0790	Backhaus svorka na papír; 12,0 cm	Backhaus paper forceps; 12 cm	60
115 08 0810	Backhaus svorka na prádlo; 8,0 cm	Backhaus towel forceps; 8,0 cm	61
115 08 0820	Backhaus svorka na prádlo; 13,0 cm	Backhaus towel forceps; 13,0 cm	61
115 08 1010	Mosquito-Halsted svorka na cévy rovná; 12 cm	Mosquito-Halsted artery forceps; 12 cm	29
115 08 1020	Mosquito-Halsted svorka na cévy zahnutá; 12 cm	Mosquito-Halsted artery forceps; 12 cm	29
115 08 1030	Mosquito-Halsted svorka rovná 1×2 zuby; 12 cm	Mosquito-Halsted artery forceps 1×2 teeth; 12 cm	29
115 08 1050	Mosquito-Halsted zahnutá svorka 1×2 zuby; 12 cm	Mosquito-Halsted artery forceps 1×2 teeth; 12 cm	29
115 08 1080	Baby-Mixter svorka preparační zahnutá; 14 cm	Baby-Mixter dissecting forceps; 14,0 cm	47
115 14 0010	Micro-Bulldog svorka na cévy rovná; 2,6 cm	Micro-Bulldog artery forceps; 2,6 cm	25
115 14 0020	Micro-Bulldog svorka na cévy zahnutá; 2,4 cm	Micro-Bulldog artery forceps; 2,4 cm	25
115 14 0150	Dieffenbach svorka na cévy rovná; 6,5 cm	Dieffenbach artery forceps; 6,5 cm	26
115 14 0160	Dieffenbach svorka na cévy zahnutá; 6,5 cm	Dieffenbach artery forceps; 6,5 cm	26
115 14 1150	Overholt svorka na lobektomii fig. 1; 19,5 cm	Overholt lobectomy forceps fig. 1; 19,5 cm	37
115 14 1160	Overholt svorka na lobektomii fig. 2; 22,2 cm	Overholt lobectomy forceps Fig. 2; 22,2 cm	37
115 14 1170	Semb uvolňovač mírně zahnutý matovaný; 21,4 cm	Semb dissecting forceps; 21,4 cm	49
115 14 1180	Semb uvolňovač silně zahnutý matovaný; 25,0 cm	Semb dissecting forceps; 25,0 cm	49
115 14 1190	Semb uvolňovač silně zahnutý jemný mat; 25,0 cm	Semb dissecting forceps; 25,0 cm	49
115 14 1410	Svorka atraumatická fig. 1; 22,0 cm	Artery forceps atraumatic jaws fig. 1; 22,0 cm	38
115 14 1420	Svorka atraumatická fig. 2; 22,0 cm	Artery forceps atraumatic jaws fig. 2; 22,0 cm	38
115 14 1430	Svorka atraumatická fig. 3; 23,5 cm	Artery forceps atraumatic jaws fig. 3; 23,5 cm	38
115 14 1440	Svorka atraumatická fig. 4; 20,5 cm	Artery forceps atraumatic jaws fig. 4; 20,5 cm	38
115 14 1450	Svorka atraumatická fig. 5; 20,5 cm	Artery forceps atraumatic jaws fig. 5; 20,5 cm	38
115 14 1460	Svorka atraumatická fig. 6; 22,0 cm	Artery forceps atraumatic jaws fig. 6; 22,0 cm	39
115 14 1470	Svorka atraumatická fig. 7; 22,0 cm	Artery forceps atraumatic jaws fig. 7; 22,0 cm	39
115 14 1480	Svorka atraumatická fig. 8; 22,4 cm	Artery forceps atraumatic jaws fig. 8; 22,4 cm	39
115 14 1490	Svorka atraumatická fig. 9; 23,0 cm	Artery forceps atraumatic jaws fig. 9; 23,0 cm	39
115 14 1500	Svorka atraumatická fig. 10; 24,5 cm	Artery forceps atraumatic jaws fig. 10; 24,5 cm	39
115 14 1600	Sarot uvolňovač zahnutý; 23,0 cm	Sarot dissecting forceps; 23,0 cm	44
115 19 0010	Svorka na střeva rovná; 20,0 cm	Intestinal forceps; 20,0 cm	56
115 19 0020	Svorka na střeva zahnutá; 20,0 cm	Intestinal forceps; 20,0 cm	56
115 19 0070	Svorka na střeva rovná; 24,0 cm	Intestinal forceps; 24,0 cm	56
115 19 0080	Svorka na střeva jemná zahnutá; 23,5 cm	Intestinal forceps; 23,5 cm	56
115 27 0070	Mikulicz svorka na pobřišnici; 18,0 cm	Mikulicz peritoneal forceps; 18,0 cm	59
115 91 0031	Dieffenbach svorka na cévy rovná; 3,5 cm	Dieffenbach artery forceps; 3,5 cm	26
115 91 0032	Dieffenbach svorka na cévy rovná; 5,0 cm	Dieffenbach artery forceps; 5,0 cm	26
115 91 0034	Dieffenbach svorka na cévy zahnutá; 3,5 cm	Dieffenbach artery forceps; 3,5 cm	26
115 91 0035	Dieffenbach svorka na cévy zahnutá; 3,5 cm	Dieffenbach artery forceps; 3,5 cm	26
115 91 0037	Johns-Hopkins svorka na cévy; 24,5 cm	Johns-Hopkins artery forceps; 24,5 cm	26
115 91 0039	Johns-Hopkins svorka na cévy rovná; 5,0 cm	Johns-Hopkins artery forceps; 5,0 cm	26
115 91 0040	Johns-Hopkins svorka na cévy rovná; 6,5 cm	Johns-Hopkins artery forceps; 6,5 cm	26
115 91 0041	Johns-Hopkins svorka na cévy rovná; 7,5 cm	Johns-Hopkins artery forceps; 7,5 cm	26
115 91 0042	Johns-Hopkins svorka na cévy rovná; 9,0 cm	Johns-Hopkins artery forceps; 9,0 cm	26
115 91 0044	Johns-Hopkins svorka na cévy zahnutá; 5,0 cm	Johns-Hopkins artery forceps; 5,0 cm	26
115 91 0045	Johns-Hopkins svorka na cévy zahnutá; 6,5 cm	Johns-Hopkins artery forceps; 6,5 cm	26
115 91 0046	Johns-Hopkins svorka na cévy zahnutá; 7,5 cm	Johns-Hopkins artery forceps; 7,5 cm	26
115 91 0047	Johns-Hopkins svorka na cévy zahnutá; 9,0 cm	Johns-Hopkins artery forceps; 9,0 cm	26
115 91 0048	Chaput svorka na cévy 3×2 zuby; 13,0 cm	Chaput artery forceps 3×2 teeth; 13,0 cm	27
115 91 0049	Tuffier svorka na cévy 5×4 zuby; 13,0 cm	Tuffier artery forceps 5×4 teeth; 13,0 cm	27
115 91 0050	Martel svorka na chlopeň; 14,0 cm	Martel flap forceps; 14,0 cm	27
115 91 0051	Willet-Martel svorka na chlopeň; 19,0 cm	Willet-Martel flap forceps; 19,0 cm	27
115 91 0052	Pean svorka na cévy rovná; 14,0 cm	Pean artery forceps; 14,0 cm	28
115 91 0053	Pean svorka na cévy rovná; 16,0 cm	Pean artery forceps; 16,0 cm	28
115 91 0068	Hartmann svorka rovná; 10,0 cm	Hartmann forceps; 10,0 cm	28
115 91 0069	Hartmann svorka zahnutá; 10,0 cm	Hartmann forceps; 10,0 cm	28
115 91 0073	Micro-Mosquito svorka na cévy rovná; 12,0 cm	Micro-Mosquito artery forceps; 12,0 cm	30
115 91 0075	Micro-Mosquito svorka na cévy zahnutá; 12,0 cm	Micro-Mosquito artery forceps; 12,0 cm	30
115 91 0077	Micro-Mosquito svorka rovná 1×2 zuby; 12,0 cm	Micro-Mosquito artery forceps 1×2 teeth; 12,0 cm	30
115 91 0079	Micro-Mosquito svorka zahnutá 1×2 zuby; 12,0 cm	Micro-Mosquito artery forceps 1×2 teeth; 12,0 cm	30
115 91 0080	Halsted-Mosquito svorka na cévy rovná; 12,5 cm	Halsted-Mosquito artery forceps; 12,5 cm	30
115 91 0082	Halsted-Mosquito svorka na cévy zahnutá; 12,5 cm	Halsted-Mosquito artery forceps; 12,5 cm	30
115 91 0084	Halsted-Mosquito svorka rovná 1×2 zuby; 12,5 cm	Halsted-Mosquito artery forceps 1×2 teeth; 12,5 cm	30
115 91 0086	Halsted-Mosquito svorka zahnutá 1×2 zuby; 12,5 cm	Halsted-Mosquito artery forceps 1×2 teeth; 12,5 cm	30
115 91 0097	Leriche svorka na cévy rovná; 15,0 cm	Leriche artery forceps; 15,0 cm	31
115 91 0098	Leriche svorka na cévy zahnutá; 15,0 cm	Leriche artery forceps; 15,0 cm	31
115 91 0099	Leriche svorka na cévy rovná 1×2 zuby; 15,0 cm	Leriche artery forceps 1×2 teeth; 15,0 cm	31

číslo – number	název	item	strana – page
115 91 0100	Leriche svorka na cévy zahnutá 1×2 zuby; 15,0 cm	Leriche artery forceps 1×2 teeth; 15,0 cm	31
115 91 0101	Providence-Hospital svorka na cévy rovná; 14 cm	Providence-Hospital artery forceps; 14,0 cm	31
115 91 0102	Providence-Hospital svorka na cévy zahnutá; 14cm	Providence-Hospital artery forceps; 14,0 cm	31
115 91 0103	Kelly svorka na cévy rovná; 14,0 cm	Kelly artery forceps; 14,0 cm	33
115 91 0105	Kelly-Rankin svorka na cévy rovná; 16,0 cm	Kelly-Rankin artery forceps; 16,0 cm	33
115 91 0106	Kelly-Rankin svorka na cévy zahnutá; 16,0 cm	Kelly-Rankin artery forceps; 16,0 cm	33
115 91 0111	Crile svorka na cévy rovná; 14,0 cm	Crile artery forceps; 14,0 cm	33
115 91 0112	Crile svorka na cévy zahnutá; 14,0 cm	Crile artery forceps; 14,0 cm	33
115 91 0113	Crile svorka na cévy rovná 1×2 zuby; 14,0 cm	Crile artery forceps 1×2 teeth; 14,0 cm	33
115 91 0114	Crile svorka na cévy zahnutá 1×2 zuby; 14,0 cm	Crile artery forceps 1×2 teeth; 14,0 cm	33
115 91 0115	Crile-Rankin svorka na cévy rovná; 16,0 cm	Crile-Rankin artery forceps; 16,0 cm	33
115 91 0116	Crile-Rankin svorka na cévy zahnutá; 16,0 cm	Crile-Rankin artery forceps; 16,0 cm	33
115 91 0117	Rochester-Pean svorka na cévy rovná; 14,0 cm	Rochester-Pean artery forceps; 14,0 cm	34
115 91 0118	Rochester-Pean svorka na cévy rovná; 16,0 cm	Rochester-Pean artery forceps; 16,0 cm	34
115 91 0119	Rochester-Pean svorka na cévy rovná; 18,0 cm	Rochester-Pean artery forceps; 18,0 cm	34
115 91 0120	Rochester-Pean svorka na cévy rovná; 20,0 cm	Rochester-Pean artery forceps; 20,0 cm	34
115 91 0121	Rochester-Pean svorka na cévy rovná; 22,0 cm	Rochester-Pean artery forceps; 22,0 cm	34
115 91 0123	Rochester-Pean svorka na cévy rovná; 26,0 cm	Rochester-Pean artery forceps; 26,0 cm	34
115 91 0124	Rochester-Pean svorka na cévy rovná; 30,0 cm	Rochester-Pean artery forceps; 30,0 cm	34
115 91 0125	Rochester-Pean svorka na cévy zahnutá; 14,0 cm	Rochester-Pean artery forceps; 14,0 cm	35
115 91 0126	Rochester-Pean svorka na cévy zahnutá; 16,0 cm	Rochester-Pean artery forceps; 16,0 cm	35
115 91 0127	Rochester-Pean svorka na cévy zahnutá; 18,0 cm	Rochester-Pean artery forceps; 18,0 cm	35
115 91 0128	Rochester-Pean svorka na cévy zahnutá; 20,0 cm	Rochester-Pean artery forceps; 20,0 cm	35
115 91 0129	Rochester-Pean svorka na cévy zahnutá; 22,0 cm	Rochester-Pean artery forceps; 22,0 cm	35
115 91 0130	Rochester-Pean svorka na cévy zahnutá; 24,0 cm	Rochester-Pean artery forceps; 24,0 cm	35
115 91 0131	Rochester-Pean svorka na cévy zahnutá; 26,0 cm	Rochester-Pean artery forceps; 26,0 cm	35
115 91 0132	Rochester-Pean svorka na cévy zahnutá; 30,0 cm	Rochester-Pean artery forceps; 30,0 cm	35
115 91 0133	Ochsner-Kocher svorka na cévy rovná; 14,0 cm	Ochsner-Kocher artery forceps; 14,0 cm	36
115 91 0134	Ochsner-Kocher svorka na cévy rovná; 16,0 cm	Ochsner-Kocher artery forceps; 16,0 cm	36
115 91 0135	Ochsner-Kocher svorka na cévy rovná; 18,0 cm	Ochsner-Kocher artery forceps; 18,0 cm	36
115 91 0136	Ochsner-Kocher svorka na cévy rovná; 20,0 cm	Ochsner-Kocher artery forceps; 20,0 cm	36
115 91 0137	Ochsner-Kocher svorka na cévy rovná; 22,0 cm	Ochsner-Kocher artery forceps; 22,0 cm	36
115 91 0138	Ochsner-Kocher svorka na cévy rovná; 24,0 cm	Ochsner-Kocher artery forceps; 24,0 cm	36
115 91 0139	Ochsner-Kocher svorka na cévy rovná; 26,0 cm	Ochsner-Kocher artery forceps; 26,0 cm	36
115 91 0140	Ochsner-Kocher svorka na cévy rovná; 30,0 cm	Ochsner-Kocher artery forceps; 30,0 cm	36
115 91 0141	Ochsner-Kocher svorka na cévy zahnutá; 14,0 cm	Ochsner-Kocher artery forceps; 14,0 cm	36
115 91 0142	Ochsner-Kocher svorka na cévy zahnutá; 16,0 cm	Ochsner-Kocher artery forceps; 16,0 cm	36
115 91 0143	Ochsner-Kocher svorka na cévy zahnutá; 18,0 cm	Ochsner-Kocher artery forceps; 18,0 cm	36
115 91 0144	Ochsner-Kocher svorka na cévy zahnutá; 20,0 cm	Ochsner-Kocher artery forceps; 20,0 cm	36
115 91 0145	Ochsner-Kocher svorka na cévy zahnutá; 22,0 cm	Ochsner-Kocher artery forceps; 22,0 cm	36
115 91 0146	Ochsner-Kocher svorka na cévy zahnutá; 24,0 cm	Ochsner-Kocher artery forceps; 24,0 cm	36
115 91 0147	Ochsner-Kocher svorka na cévy zahnutá; 26,0 cm	Ochsner-Kocher artery forceps; 26,0 cm	36
115 91 0148	Ochsner-Kocher svorka na cévy zahnutá; 30,0 cm	Ochsner-Kocher artery forceps; 30,0 cm	36
115 91 0161	Overholt-Geissendoerfer svorka na cévy fig. 1	Overholt-Geissendoerfer artery forceps fig. 1	37
115 91 0162	Overholt-Geissendoerfer svorka na cévy fig. 2	Overholt-Geissendoerfer artery forceps fig. 2	37
115 91 0163	Overholt-Geissendoerfer svorka na cévy fig. 3	Overholt-Geissendoerfer artery forceps fig. 3	37
115 91 0164	Overholt-Geissendoerfer svorka na cévy fig. 4	Overholt-Geissendoerfer artery forceps fig. 4	37
115 91 0165	Overholt-Geissendoerfer svorka na cévy fig. 5	Overholt-Geissendoerfer artery forceps fig. 5	37
115 91 0166	Overholt-Geissendoerfer svorka na cévy fig. 6	Overholt-Geissendoerfer artery forceps fig. 6	37
115 91 0167	Overholt-Geissendoerfer svorka na cévy fig. 7	Overholt-Geissendoerfer artery forceps fig. 7	37
115 91 0168	Overholt-Geissendoerfer svorka na cévy fig. 1	Overholt-Geissendoerfer artery forceps fig. 1	37
115 91 0169	Overholt-Geissendoerfer svorka na cévy fig. 2	Overholt-Geissendoerfer artery forceps fig. 2	37
115 91 0170	Overholt-Geissendoerfer svorka na cévy fig. 3	Overholt-Geissendoerfer artery forceps fig. 3	37
115 91 0171	Overholt-Geissendoerfer svorka na cévy fig. 4	Overholt-Geissendoerfer artery forceps fig. 4	37
115 91 0172	Overholt-Geissendoerfer svorka na cévy fig. 5	Overholt-Geissendoerfer artery forceps fig. 5	37
115 91 0173	Overholt-Geissendoerfer svorka na cévy fig. 6	Overholt-Geissendoerfer artery forceps fig. 6	37
115 91 0174	Overholt-Geissendoerfer svorka na cévy fig. 7	Overholt-Geissendoerfer artery forceps fig. 7	37
115 91 0176	Overholt svorka na cévy s-prohnutá; 18,5 cm	Overholt artery forceps; 18,5 cm	40
115 91 0177	Overholt svorka na cévy s-prohnutá; 20,5 cm	Overholt artery forceps; 20,5 cm	40
115 91 0178	Overholt svorka na cévy s-prohnutá; 21,0 cm	Overholt artery forceps; 21,0 cm	40
115 91 0179	Overholt svorka na cévy s-prohnutá; 21,5 cm	Overholt artery forceps; 21,5 cm	40
115 91 0180	Baby-Adson svorka na cévy zahnutá; 14,0 cm	Baby-Adson artery forceps; 14,0 cm	41
115 91 0181	Baby-Adson svorka na cévy zahnutá; 18,0 cm	Baby-Adson artery forceps; 18,0 cm	41
115 91 0182	Adson svorka na cévy rovná; 18,5 cm	Adson artery forceps; 18,5 cm	41
115 91 0183	Adson svorka na cévy zahnutá; 18,5 cm	Adson artery forceps; 18,5 cm	41
115 91 0184	Adson svorka na cévy rovná 1×2 zuby; 18,5 cm	Adson artery forceps 1×2 teeth; 18,5 cm	41
115 91 0185	Adson svorka na cévy zahnutá 1×2 zuby; 18,5 cm	Adson artery forceps 1×2 teeth; 18,5 cm	41
115 91 0186	Meeker svorka na cévy zahnutá; 18,0 cm	Meeker artery forceps; 18,0 cm	41
115 91 0187	Meeker svorka na cévy zahnutá; 28,0 cm	Meeker artery forceps; 28,0 cm	41
115 91 0192	Schmidt-Sawtell svorka mírně zahnutá; 19,0 cm	Schmidt-Sawtell artery forceps; 19,0 cm	42

číslo – number	název	item	strana – page
115 91 0193	Schmidt-Sawtell svorka silně zahnutá; 19,0 cm	Schmidt-Sawtell artery forceps; 19,0 cm	42
115 91 0196	Rochester-Carmalt svorka na cévy rovná; 16,0 cm	Rochester-Carmalt artery forceps; 16,0 cm	42
115 91 0197	Rochester-Carmalt svorka na cévy rovná; 20,0 cm	Rochester-Carmalt artery forceps; 20,0 cm	42
115 91 0198	Rochester-Carmalt svorka na cévy zahnutá; 16 cm	Rochester-Carmalt artery forceps; 16,0 cm	42
115 91 0199	Rochester-Carmalt svorka na cévy zahnutá; 20 cm	Rochester-Carmalt artery forceps; 20,0 cm	42
115 91 0200	Bainbridge svorka na cévy rovná; 15,0 cm	Bainbridge artery forceps; 15,0 cm	42
115 91 0201	Bainbridge svorka na cévy rovná; 18,5 cm	Bainbridge artery forceps; 18,5 cm	42
115 91 0202	Bainbridge svorka na cévy zahnutá; 15,0 cm	Bainbridge artery forceps; 15,0 cm	42
115 91 0203	Bainbridge svorka na cévy zahnutá; 18,5 cm	Bainbridge artery forceps; 18,5 cm	42
115 91 0216	Heiss svorka na cévy rovná fig. 1; 20,0 cm	Heiss artery forceps fig. 1; 20,0 cm	44
115 91 0217	Heiss svorka na cévy mírně zahnutá; 20,0 cm	Heiss artery forceps; 20,0 cm	44
115 91 0218	Heiss svorka na cévy silně zahnutá; 20,0 cm	Heiss artery forceps; 20,0 cm	44
115 91 0219	Roberts svorka na cévy rovná; 22,0 cm	Roberts artery forceps; 22,0 cm	44
115 91 0220	Roberts svorka na cévy zahnutá; 22,0 cm	Roberts artery forceps; 22,0 cm	44
115 91 0221	Sarot svorka na cévy rovná; 24,0 cm	Sarot artery forceps; 24,0 cm	44
115 91 0223	Crafoord svorka na cévy zahnutá; 24,0 cm	Crafoord artery forceps; 24,0 cm	44
115 91 0224	Rumel svorka preparační fig. 1; 23,0 cm	Rumel dissecting forceps fig. 1; 23,0 cm	45
115 91 0225	Rumel svorka preparační fig. 2; 23,0 cm	Rumel dissecting forceps fig. 2; 23,0 cm	45
115 91 0226	Rumel svorka preparační fig. 3; 23,0 cm	Rumel dissecting forceps fig. 3; 23,0 cm	45
115 91 0227	Rumel svorka preparační fig. 4; 23,0 cm	Rumel dissecting forceps fig. 4; 23,0 cm	45
115 91 0229	Zenker svorka preparační mírně zahnutá; 29,5 cm	Zenker dissecting forceps; 29,5 cm	45
115 91 0230	Zenker svorka preparační silně zahnutá; 29,5 cm	Zenker dissecting forceps; 29,5 cm	45
115 91 0231	Mixer svorka preparační zahnutá; 15,5 cm	Mixer dissecting forceps; 15,5 cm	47
115 91 0232	Mixer svorka preparační zahnutá; 19,0 cm	Mixer dissecting forceps; 19,0 cm	47
115 91 0233	Mixer-0'Shaugnessy svorka preparační; 15,5 cm	Mixer-0'Shaugnessy dissecting forceps; 15,5 cm	47
115 91 0234	Mixer-0'Shaugnessy svorka preparační; 19,0 cm	Mixer-0'Shaugnessy dissecting forceps; 19,0 cm	47
115 91 0235	Baby-Mixer svorka preparační zahnutá; 18,0 cm	Baby-Mixer dissecting forceps; 18,0 cm	47
115 91 0238	Mixer svorka preparační fig. 1; 22,0 cm	Mixer dissecting forceps fig. 1; 22,0 cm	47
115 91 0239	Mixer svorka preparační fig. 2; 25,0 cm	Mixer dissecting forceps fig. 2; 25,0 cm	47
115 91 0240	Mixer svorka preparační fig. 3; 28,0 cm	Mixer dissecting forceps fig. 3; 28,0 cm	47
115 91 0242	Bridge svorka preparační rovná; 28,0 cm	Bridge dissecting forceps; 28,0 cm	46
115 91 0243	Bridge svorka preparační zahnutá; 28,0 cm	Bridge dissecting forceps; 28,0 cm	46
115 91 0244	Lawrence svorka preparační zahnutá; 28,0 cm	Lawrence dissecting forceps; 28,0 cm	46
115 91 0245	Kantrowitz svorka preparační zahnutá; 20,0 cm	Kantrowitz dissecting forceps; 20,0 cm	48
115 91 0246	Kantrowitz svorka preparační zahnutá; 24,0 cm	Kantrowitz dissecting forceps; 24,0 cm	48
115 91 0247	Kantrowitz svorka preparační zahnutá; 28,0 cm	Kantrowitz dissecting forceps; 28,0 cm	48
115 91 0249	Gemini svorka preparační zahnutá; 18,0 cm	Gemini dissecting forceps; 18,0 cm	48
115 91 0251	Gemini svorka preparační zahnutá; 25,0 cm	Gemini dissecting forceps; 25,0 cm	48
115 91 0252	Gemini svorka preparační zahnutá; 28,0 cm	Gemini dissecting forceps; 28,0 cm	48
115 91 0253	Toennis svorka preparační rovná; 21,0 cm	Toennis dissecting forceps; 21,0 cm	48
115 91 0254	Toennis svorka preparační rovná; 26,0 cm	Toennis dissecting forceps; 26,0 cm	48
115 91 0255	Toennis svorka preparační zahnutá; 21,0 cm	Toennis dissecting forceps; 21,0 cm	48
115 91 0256	Toennis svorka preparační zahnutá; 26,0 cm	Toennis dissecting forceps; 26,0 cm	48
115 91 0257	Toennis svorka preparační rovná 1×2 zuby; 21 cm	Toennis dissecting forceps 1×2 teeth; 21 cm	48
115 91 0258	Toennis svorka preparační rovná 1×2 zuby; 26 cm	Toennis dissecting forceps 1×2 teeth; 26 cm	48
115 91 0259	Toennis svorka preparační zahnutá 1×2 zuby; 21 cm	Toennis dissecting forceps 1×2 teeth; 21 cm	48
115 91 0260	Toennis svorka preparační zahnutá 1×2 zuby; 26 cm	Toennis dissecting forceps 1×2 teeth; 26 cm	48
115 91 0261	Lahey svorka na žlučovod; 19,0 cm	Lahey gall duct clamp; 19,0 cm	51
115 91 0262	Lahey svorka na žlučovod; 23,0 cm	Lahey gall duct clamp; 23,0 cm	51
115 91 0263	Lower svorka na ledviny zahnutá; 18,0 cm	Lower kidney pedicle forceps; 18,0 cm	51
115 91 0264	Finocchietto svorka na ledviny zahnutá; 24,0 cm	Finocchietto kidney forceps; 24,0 cm	51
115 91 0265	Guyon svorka na ledviny; 20,0 cm	Guyon kidney pedicle clamp-forceps; 20,0 cm	50
115 91 0266	Guyon svorka na ledviny; 22,0 cm	Guyon kidney pedicle clamp-forceps; 22,0 cm	50
115 91 0267	Guyon svorka na ledviny; 24,0 cm	Guyon kidney pedicle clamp-forceps; 24,0 cm	50
115 91 0268	Stille svorka na ledviny; 23,0 cm	Stille kidney forceps; 23,0 cm	50
115 91 0269	Guyon svorka na ledviny; 23,0 cm	Guyon kidney pedicle clamp-forceps; 23,0 cm	50
115 91 0270	Herrick svorka na ledviny; 23,0 cm	Herrick kidney forceps; 23,0 cm	50
115 91 0271	Gray svorka na žlučovod s-prohnutá; 22,0 cm	Gray gall duct clamp; 22,0 cm	52
115 91 0272	Gray svorka na žlučovod s-prohnutá; 23,0 cm	Gray gall duct clamp; 23,0 cm	52
115 91 0273	Gray svorka na žlučovod 1×2 zuby tvar-; 22 cm	Gray gall duct clamp 1×2 teeth; 22,0 cm	52
115 91 0274	Gray svorka na žlučovod 1×2 zuby tvar-; 23 cm	Gray gall duct clamp 1×2 teeth; 23,0 cm	52
115 91 0275	Desjardins svorka na žlučovod; 21,0 cm	Desjardins gall duct forceps; 21,0 cm	52
115 91 0276	Negus svorka na žlučovod fig. 1; 19,0 cm	Negus gall duct clamp fig. 1; 19,0 cm	52
115 91 0277	Negus svorka na žlučovod fig. 2; 19,0 cm	Negus gall duct clamp fig. 2; 19,0 cm	52
115 91 0281	Wertheim svorka na hysterektomii; 27,0 cm	Wertheim hysterectomy forceps; 27,0 cm	53
115 91 0282	Wertheim svorka na hysterektomii silná; 24 cm	Wertheim hysterectomy forceps; 24 cm	53
115 91 0283	Wertheim svorka na hysterektomii; 25,0 cm	Wertheim hysterectomy forceps; 25,0 cm	53
115 91 0284	Wertheim svorka mírně zahnutá 1×2 zuby; 23,0 cm	Wertheim hysterectomy forceps 1×2 teeth; 23,0 cm	54
115 91 0285	Wertheim svorka silně zahnutá 1×2 zuby; 23,0 cm	Wertheim hysterectomy forceps 1×2 teeth; 23,0 cm	54
115 91 0286	Heaney svorka na hysterektomii; 21,0 cm	Heaney hysterectomy clamp-forceps; 21,0 cm	54

číslo – number	název	item	strana – page
115 91 0287	Heaney svorka na hysterektomii 1 zub; 21,0 cm	Heaney hysterectomy clamp-forceps 1 tooth; 21,0 cm	54
115 91 0288	Heaney svorka na hysterektomii 1 zub; 23,0 cm	Heaney hysterectomy clamp-forceps 1 tooth; 23,0 cm	54
115 91 0289	Heaney svorka na hysterektomii 2 zuby; 21,0 cm	Heaney hysterectomy clamp-forceps 2 teeth; 21,0 cm	54
115 91 0290	Heaney svorka na hysterektomii 2 zuby; 23,0 cm	Heaney hysterectomy clamp-forceps 2 teeth; 23,0 cm	54
115 91 0291	Heaney-Ballantine svorka rovná; 21,0 cm	Heaney-Ballantine hysterectomy clamp-forceps; 21,0 cm	55
115 91 0292	Heaney-Ballantine svorka zahnutá; 21,0 cm	Heaney-Ballantine hysterectomy clamp-forceps; 21,0 cm	55
115 91 0299	Wertheim-Cullen svorka na hysterektomii; 21,5 cm	Wertheim-Cullen hysterectomy forceps; 21,5 cm	55
115 91 0300	Phaneuf svorka rovná 1×2 zubů; 21,5 cm	Phaneuf hysterectomy forceps 1×2 teeth; 21,5 cm	55
115 91 0301	Phaneuf svorka zahnutá 1×2 zubů; 21,5 cm	Phaneuf hysterectomy forceps 1×2 teeth; 21,5 cm	55
115 91 0305	Parametrium svorka rovná; 21,0 cm	Parametrium forceps; 21,0 cm	57
115 91 0306	Parametrium svorka zahnutá fig. 1; 21,0 cm	Parametrium forceps fig. 1; 21,0 cm	57
115 91 0307	Parametrium svorka zahnutá fig. 2; 21,0 cm	Parametrium forceps fig. 2; 21,0 cm	57
115 91 0308	Parametrium svorka zahnutá fig. 3; 21,0 cm	Parametrium forceps fig. 3; 21,0 cm	57
115 91 0309	Parametrium svorka rovná; 24,0 cm	Parametrium forceps; 24,0 cm	57
115 91 0310	Parametrium svorka zahnutá fig. 1; 24,0 cm	Parametrium forceps fig. 1; 24,0 cm	57
115 91 0311	Parametrium svorka zahnutá fig. 2; 24,0 cm	Parametrium forceps fig. 2; 24,0 cm	57
115 91 0312	Parametrium svorka zahnutá fig. 3; 24,0 cm	Parametrium forceps fig. 3; 24,0 cm	57
115 91 0313	Fergusson svorka rovná; 16,0 cm	Fergusson angiotribe clamp; 16,0 cm	58
115 91 0314	Fergusson svorka rovná; 20,0 cm	Fergusson angiotribe clamp; 20,0 cm	58
115 91 0315	Fergusson svorka zahnutá; 16,0 cm	Fergusson angiotribe clamp; 16,0 cm	58
115 91 0316	Fergusson svorka zahnutá; 20,0 cm	Fergusson angiotribe clamp; 20,0 cm	58
115 91 0317	Pratt svorka na hemeroidy; 15,0 cm	Pratt haemorrhoidal forceps; 15,0 cm	58
115 91 0322	Baby-Mikulicz svorka na pobřišnici; 14,0 cm	Baby-Mikulicz peritoneal forceps; 14,0 cm	59
115 91 0326	Mikulicz svorka na pobřišnici 1×2 zuby; 20,0 cm	Mikulicz peritoneal forceps 1×2 teeth; 21,0 cm	59
115 91 0329	Faure svorka na pobřišnici 1×2 zuby; 20,0 cm	Faure peritoneal forceps 1×2 teeth; 21,0 cm	59
115 91 0330	Faure svorka na pobřišnici 1×2 zuby; 20,0 cm	Faure peritoneal forceps 1×2 teeth; 21,0 cm	59
115 91 0332	Schaedel svorka na prádlo; 9,0 cm	Schaedel towel forceps; 9,0 cm	60
115 91 0333	Jones svorka na prádlo; 5,0 cm	Jones towel forceps; 5,0 cm	60
115 91 0334	Jones svorka na prádlo; 9,0 cm	Jones towel forceps; 9,0 cm	60
115 91 0335	Engl. modell svorka na prádlo; 9,0 cm	Eng. modell towel forceps; 9,0 cm	60
115 91 0336	Doyen svorka na prádlo; 18,0 cm	Doyen towel forceps; 18,0 cm	60
115 91 0337	Bernhard svorka na prádlo; 16,5 cm	Bernhard towel forceps; 16,5 cm	60
115 91 0338	Lane svorka na prádlo; 15,0 cm	Lane towel forceps; 15,0 cm	60
115 91 0339	Lane svorka na prádlo; 18,0 cm	Lane towel forceps; 18,0 cm	60
115 91 0340	Lane svorka na prádlo; 20,0 cm	Lane towel forceps; 20,0 cm	60
115 91 0341	Backhaus-Clip svorka na prádlo; 11,0 cm	Backhaus-Clip towel forceps; 11,0 cm	61
115 91 0343	Backhaus svorka na prádlo; 11,0 cm	Backhaus towel forceps; 11,0 cm	61
115 91 0345	Backhaus svorka na prádlo; 11,0 cm	Backhaus towel forceps; 11,0 cm	61
115 91 0348	Roeder svorka na prádlo; 13,0 cm	Roeder towel forceps; 13,0 cm	61
115 91 0349	Roeder svorka na prádlo; 15,0 cm	Roeder towel forceps; 15,0 cm	61
115 91 0350	Lorna svorka na prádlo; 10,0 cm	Lorna towel forceps; 10,0 cm	61
115 91 0351	Lorna svorka na prádlo; 13,0 cm	Lorna towel forceps; 13,0 cm	61
115 91 0352	Tohoku-Japan svorka na prádlo; 10,0 cm	Tohoku-Japan towel forceps; 10,0 cm	61
115 91 0353	Tohoku-Japan svorka na prádlo; 13,0 cm	Tohoku-Japan towel forceps; 13,0 cm	61
115 91 0354	Peers svorka na prádlo; 14,5 cm	Peers towel forceps; 14,5 cm	61
115 91 0364	Allis svorka chirurgická 4×5 zubů; 15,0 cm	Allis tissue forceps 4×5 teeth; 15,0 cm	25
115 91 0365	Allis svorka chirurgická 5×6 zubů; 15,0 cm	Allis tissue forceps 5×6 teeth; 15,0 cm	25
115 91 0366	Allis svorka chirurgická 5×6 zubů; 19,0 cm	Allis tissue forceps 5×6 teeth; 19,0 cm	25
115 91 0367	Allis svorka chirurgická 5×6 zubů; 25,0 cm	Allis tissue forceps 5×6 teeth; 25,0 cm	25
115 91 0382	Babcock svorka chirurgická; 16,0 cm	Babcock tissue clamp; 16,0 cm	25
115 91 0384	Babcock svorka chirurgická; 18,0 cm	Babcock tissue clamp; 18,0 cm	25
115 91 0385	Babcock svorka chirurgická; 20,0 cm	Babcock tissue clamp; 20,0 cm	25
115 91 0386	Babcock svorka chirurgická; 24,0 cm	Babcock tissue clamp; 24,0 cm	25
116	KLEŠTĚ ŠTÍPACÍ	BONE RONGEURS	
116 91 0022	Tischler kleště na biopsii; 22,0 cm	Tischler biopsy forceps; 22,0 cm	63
116 91 0024	Baby-Tischler kleště na biopsii; 20,0 cm	Baby-Tischler biopsy forceps; 20,0 cm	63
116 91 0025	Tischler-Morgan kleště na biopsii; 22,0 cm	Tischler-Morgan biopsy forceps; 22,0 cm	63
116 91 0026	Gellhorn kleště na biopsii; 23,0 cm	Gellhorn biopsy forceps; 23,0 cm	64
116 91 0027	Faure kleště na biopsii; 23,0 cm	Faure biopsy forceps; 23,0 cm	64
116 91 0028	Schubert kleště na biopsii; 21,0 cm	Schubert biopsy forceps; 21,0 cm	64
116 91 0029	Schubert kleště na biopsii; 29,0 cm	Schubert biopsy forceps; 29,0 cm	64
116 91 0030	Thoms-Gaylor kleště na biopsii; 24,0 cm	Thoms-Gaylor biopsy forceps; 24,0 cm	65
116 91 0031	Schubert kleště na biopsii; 26,0 cm	Schubert biopsy forceps; 26,0 cm	65
116 91 0032	Tischler kleště na biopsii; 27,0 cm	Tischler biopsy forceps; 27,0 cm	65
116 91 0033	Schumacher-Van Doren kleště na biopsii fig. 1	Schumacher-Van Doren biopsy forceps fig. 1	66
116 91 0034	Schumacher-Van Doren kleště na biopsii fig. 2	Schumacher-Van Doren biopsy forceps fig. 2	66
116 91 0035	Van Doren kleště na biopsii; 25,0 cm	Van Doren biopsy forceps; 25,0 cm	66
116 91 0036	Van Doren kleště na biopsii; 25,0 cm	Van Doren biopsy forceps; 25,0 cm	66
116 91 0037	Alexander kleště na biopsii; 20,0 cm	Alexander biopsy forceps; 20,0 cm	67
116 91 0038	Kevorkian kleště na biopsii; 23,0 cm	Kevorkian biopsy forceps; 23,0 cm	67

číslo – number	název	item	strana – page
116 91 0039	Kevorkian kleště na biopsii; 25,0 cm	Kevorkian biopsy forceps; 25,0 cm	67
116 91 0040	Schumacher kleště na biopsii fig. 1; 24,0 cm	Schumacher biopsy forceps fig. 1; 24,0 cm	67
116 91 0041	Schumacher kleště na biopsii fig. 2; 24,0 cm	Schumacher biopsy forceps fig. 2; 24,0 cm	67
116 91 0042	Wittner kleště na biopsii; 23,0 cm	Wittner biopsy forceps; 23,0 cm	68
116 91 0043	Wittner kleště na biopsii lomené; 23,0 cm	Wittner biopsy forceps; 23,0 cm	68
116 91 0044	Douay kleště na biopsii; 20,0 cm	Douay biopsy forceps; 20,0 cm	69
116 91 0045	Douay kleště na biopsii; 25,0 cm	Douay biopsy forceps; 25,0 cm	69
116 91 0046	Douay kleště na biopsii; 30,0 cm	Douay biopsy forceps; 30,0 cm	69
116 91 0047	Douay kleště na biopsii; 35,0 cm	Douay biopsy forceps; 35,0 cm	69
116 91 0048	Douay kleště na biopsii; 40,0 cm	Douay biopsy forceps; 40,0 cm	69
116 91 0049	Tischler držadlo	Tischler handle	70
116 91 0050	Tischler koncovka; 25,0 cm	Tischler tip; 25,0 cm	70
116 91 0051	Kevorkian koncovka; 25,0 cm	Kevorkian biopsy tip; 25,0 cm	70
116 91 0052	Eppendorf koncovka; 25,0 cm	Eppendorf biopsy tip; 25,0 cm	70
116 91 0053	Mini-Townsend koncovka; 25,0 cm	Mini-Townsend biopsy tip; 25,0 cm	70
116 91 0054	Eppendorf kleště na biopsii; 20,0 cm	Eppendorf biopsy forceps; 20,0 cm	68
116 91 0055	Eppendorf kleště na biopsii; 23,0 cm	Eppendorf biopsy forceps; 23,0 cm	68
116 91 0542	Tischler-Kevorkian kleště na biopsii; 22,0 cm	Tischler-Kevorkian biopsy forceps; 22,0 cm	62
116 91 0543	Kevorkian-Pacific kleště na biopsii; 22,0 cm	Kevorkian-Pacific biopsy forceps; 22,0 cm	62
116 91 0544	Baby-Tischler kleště na biopsii; 20,0 cm	Baby-Tischler biopsy forceps; 20,0 cm	63
116 91 0545	Burke kleště na biopsii; 22,0 cm	Burke cervical biopsy forceps; 22,0 cm	62
116 91 0546	Berger kleště na biopsii; 20,5 cm	Berger biopsy forceps; 20,5 cm	68
117	KLEŠTĚ ÚCHOPNÉ	GRASPING FORCEPS	
117 27 0010	Schröder kleště gynekologické; 25,0 cm	Schröder gynaecological forceps; 25,0 cm	71
117 27 0020	Schröder kleště gynekologické; 25,0 cm	Schröder gynaecological forceps; 25,0 cm	72
117 27 0050	Museux kleště gynekologické; 4,5 mm	Museux gynaecological forceps; 4,5 mm	74
117 27 0150	Kleště gynekologické	Gynaecological forceps	73
117 27 0260	Gross-Maier kleště tamponové rovné; 26,0 cm	Gross-Maier sponge holding forceps; 26,0 cm	82
117 27 0270	Kleště tamponové rovné bez uzávěru; 25,7 cm	Sponge holding forceps; 25,7 cm	81
117 27 0280	Gross-Maier kleště tamponové zahnuté; 26,0 cm	Gross-Maier sponge holding forceps; 26,0 cm	82
117 27 0290	Kleště tamponové zahnuté bez uzávěru; 25,7 cm	Sponge holding forceps; 25,7 cm	81
117 27 0500	Bozemann kleště tamponové; 25,0 cm	Bozemann sponge holding forceps; 25,0 cm	82
117 27 0510	Bozemann kleště tamponové; 25,0 cm	Bozemann sponge holding forceps; 25,0 cm	82
117 28 0010	Winter kleště potratové rovné; 28,0 cm	Winter abortion forceps; 28,0 cm	78
117 28 0020	Winter kleště potratové zahnuté; 28,0 cm	Winter abortion forceps; 28,0 cm	78
117 91 0077	Dartigues kleště děložní; 27,0 cm	Dartigues uterine elevating forceps; 27,0 cm	76
117 91 0078	Somer kleště děložní zahnuté; 23,0 cm	Somer uterine elevating forceps; 23,0 cm	76
117 91 0153	Nástroj pro přenos IUD	Instrument for removal of I.U.D	83
117 91 0154	Naegele kleště porodní; 36,0 cm	Naegele perforator; 36,0 cm	79
117 91 0155	Naegele kleště porodní; 40,0 cm	Naegele perforator; 40,0 cm	79
117 91 0156	Simpson kleště porodní; 23,0 cm	Simpson obstetrical forceps; 23,0 cm	80
117 91 0157	Simpson kleště porodní; 30,0 cm	Simpson obstetrical forceps; 30,0 cm	80
117 91 0158	Simpson-Braun kleště porodní; 36,0 cm	Simpson-Braun obstetrical forceps; 36,0 cm	80
117 91 0159	Mclean kleště porodní; 36,0 cm	Mclean obstetrical forceps; 36,0 cm	80
117 91 0160	Kielland kleště porodní; 41,0 cm	Kielland forceps; 41,0 cm	80
117 91 0161	Kielland-Luikart kleště porodní; 40,0 cm	Kielland-Luikart forceps; 40,0 cm	80
117 91 0162	Wrigley kleště porodní; 28,0 cm	Wrigley obstetrical forceps; 28,0 cm	79
117 91 0163	De Lee kleště porodní; 30,0 cm	De Lee obstetrical forceps; 30,0 cm	79
117 91 0164	Piper kleště porodní; 44,0 cm	Piper obstetrical forceps; 44,0 cm	79
117 91 0165	Winter kleště potratové rovné fig. 1; 28,0 cm	Winter abortion forceps fig. 1; 28,0 cm	78
117 91 0166	Winter kleště potratové rovné fig. 2; 28,0 cm	Winter abortion forceps fig. 2; 28,0 cm	78
117 91 0167	Winter kleště potratové zahnuté fig. 1; 28,0 cm	Winter abortion forceps fig. 1; 28,0 cm	78
117 91 0168	Saenger kleště děložní rovné; 27,0 cm	Saenger ovum forceps; 27,0 cm	77
117 91 0169	Saenger kleště děložní zahnuté; 27,0 cm	Saenger ovum forceps; 27,0 cm	77
117 91 0170	Green-Armytage kleště; 22,0 cm	Green-Armytage forceps; 22,0 cm	79
117 91 0171	Naegele perforátor; 25,0 cm	Naegele perforator; 25,0 cm	83
117 91 0172	Smellie perforátor; 25,0 cm	Smellie perforator; 25,0 cm	83
117 91 0173	Tarnier basiotribe; 46,0 cm	Tarnier basiotribe; 46,0 cm	84
117 91 0174	Braun cranioclast; 42,0 cm	Braun cranioclast; 42,0 cm	84
117 91 0175	Iowa kleště děložní; 26,0 cm	Iowa tenaculum forceps; 26,0 cm	77
117 91 0176	Winter kleště potratové zahnuté fig. 2; 28,0 cm	Winter abortion forceps fig. 2; 28,0 cm	78
117 91 0201	Pozzi kleště gynekologické; 25,0 cm	Pozzi gynaecological forceps; 25,0 cm	71
117 91 0202	Barrett kleště gynekologické; 18,0 cm	Barrett gynaecological forceps; 18,0 cm	71
117 91 0203	Saigres kleště gynekologické; 4,5 mm	Saigres gynaecological forceps; 4,5 mm	73
117 91 0204	Museux kleště gynekologické rovné; 6 mm	Museux gynaecological forceps; 6 mm	74
117 91 0205	Museux kleště gynekologické rovné; 8 mm	Museux gynaecological forceps; 8 mm	74
117 91 0206	Museux kleště gynekologické rovné; 10 mm	Museux gynaecological forceps; 10 mm	74
117 91 0207	Museux kleště gynekologické zahnuté; 6 mm	Museux gynaecological forceps; 6 mm	74
117 91 0208	Museux kleště gynekologické zahnuté; 8 mm	Museux gynaecological forceps; 8 mm	74
117 91 0209	Museux kleště gynekologické zahnuté; 10 mm	Museux gynaecological forceps; 10 mm	74

číslo – number	název	item	strana – page
117 91 0210	Schröder kleště gynekologické; 24,0 cm	Schröder gynaecological forceps; 24,0 cm	72
117 91 0211	Pratt kleště gynekologické; 28,0 cm	Pratt gynaecological forceps; 28,0 cm	72
117 91 0212	Jacobs kleště gynekologické rovné; 21,0 mm	Jacobs gynaecological forceps; 21,0 mm	75
117 91 0213	Jacobs kleště gynekologické zahnuté; 21,0 mm	Jacobs gynaecological forceps; 21,0 mm	75
117 91 0214	Teale kleště gynekologické zahnuté; 23,0 mm	Teale gynaecological forceps; 23,0 mm	75
118	HÁKY	HOOKS, RETRACTORS	
118 08 0350	Volkman hák na rány dvouzubý ostrý; 21,5 cm	Volkman retractor 2 prongs sharp; 21,5 cm	85
118 08 0360	Volkman hák na rány dvouzubý tupý; 21,5 cm	Volkman retractor 2 prongs blunt; 21,5 cm	85
118 08 0390	Volkman hák na rány čtyřzubý ostrý; 22,4 cm	Volkman retractor 4 prongs sharp; 22,4 cm	85
118 08 0400	Volkman hák na rány čtyřzubý tupý; 22,4 cm	Volkman retractor 4 prongs blunt; 22,4 cm	85
118 08 0410	Volkman hák na rány šestizubý ostrý; 22,0 cm	Volkman retractor 6 prongs sharp; 22,0 cm	85
118 08 0420	Volkman hák na rány šestizubý tupý; 22,0 cm	Volkman retractor 6 prongs blunt; 22,0 cm	85
118 08 0530	Israel hák na rány čtyřzubý tupý; 40×35 mm; 24 cm	Israel retractor 4 prongs; 40×35 mm; 24 cm	86
118 08 0540	Israel hák na rány šestizubý tupý; 45×68 mm; 26 cm	Israel retractor 6 prongs; 45×68 mm; 26 cm	86
118 08 0550	Kocher hák břišní; 80×40 mm; 25,0 cm	Kocher abdominal retractor; 80×40 mm; 25,0 cm	90
118 08 0560	Kocher hák břišní; 80×50 mm; 25,0 cm	Kocher abdominal retractor; 80×50 mm; 25,0 cm	90
118 08 0800	Langenbeck hák na rány; 40×10 mm; 21,0 cm	Langenbeck retractor; 40×10 mm; 21,0 cm	87
118 08 0810	Langenbeck hák na rány; 42×13 mm; 21,0 cm	Langenbeck retractor; 42×13 mm; 21,0 cm	87
118 08 0840	Langenbeck hák na rány; 55×13 mm; 21,5 cm	Langenbeck retractor; 55×13 mm; 21,5 cm	87
118 08 1050	Kocher hák na rány; 40×35 mm; 23,0 cm	Kocher abdominal retractor; 40×35 mm; 23,0 cm	96
118 08 1060	Kocher hák na rány; 70×35 mm; 23,0 cm	Kocher abdominal retractor; 70×35 mm; 23,0 cm	88
118 08 1070	Kocher hák na rány; 100×40 mm; 23,0 cm	Kocher abdominal retractor; 100×40 mm; 23,0 cm	88
118 08 1100	Mikulicz hák břišní; 115×30 mm; 26,0 cm	Mikulicz abdominal retractor; 115×30 mm; 26,0 cm	90
118 08 1110	Mikulicz hák břišní; 135×50 mm; 26,0 cm	Mikulicz abdominal retractor; 135×50 mm; 26,0 cm	90
118 08 1120	Fritsch hák břišní; 40×35 mm; 25,5 cm	Fritsch abdominal retractor; 40×35 mm; 25,5 cm	89
118 08 1130	Fritsch hák břišní; 50×80 mm; 27,5 cm	Fritsch abdominal retractor; 50×80 mm; 27,5 cm	89
118 28 0010	Smellie hák dekapitační porodnický	Smellie decapitation hook	91
118 91 0160	Israel hák na rány čtyřzubý tupý; 45×50 mm; 25cm	Israel retractor 4 prongs; 45×50 mm; 25cm	86
118 91 0162	Israel hák na rány šestizubý tupý; 70×70 mm; 25cm	Israel retractor 6 prongs; 70×70 mm; 25cm	86
118 91 0163	Langenbeck hák na rány; 55×20 mm; 21,0 cm	Langenbeck retractor; 55×20 mm; 21,0 cm	87
118 91 0164	Langenbeck hák na rány; 60×20 mm; 21,0 cm	Langenbeck retractor; 60×20 mm; 21,0 cm	87
118 91 0165	Langenbeck hák na rány; 63×20 mm; 21,0 cm	Langenbeck retractor; 63×20 mm; 21,0 cm	87
118 91 0185	Kocher hák na rány; 40×18 mm; 23,0 cm	Kocher abdominal retractor; 40×18 mm; 23,0 cm	88
118 91 0186	Kocher hák na rány; 60×20 mm; 23,0 cm	Kocher abdominal retractor; 60×20 mm; 23,0 cm	88
118 91 0187	Kocher hák na rány; 60×25 mm; 23,0 cm	Kocher abdominal retractor; 60×25 mm; 23,0 cm	88
118 91 0188	Kocher hák na rány; 75×30 mm; 23,0 cm	Kocher abdominal retractor; 75×30 mm; 23,0 cm	88
118 91 0189	Kocher hák na rány; 75×40 mm; 23,0 cm	Kocher abdominal retractor; 75×40 mm; 23,0 cm	88
118 91 0225	Fritsch hák břišní; 45×40 mm; 24,0 cm	Fritsch abdominal retractor; 45×40 mm; 24,0 cm	89
118 91 0226	Fritsch hák břišní; 45×50 mm; 24,0 cm	Fritsch abdominal retractor; 45×50 mm; 24,0 cm	89
118 91 0227	Fritsch hák břišní; 45×60 mm; 24,0 cm	Fritsch abdominal retractor; 45×60 mm; 24,0 cm	89
118 91 0228	Fritsch hák břišní; 45×75 mm; 24,0 cm	Fritsch abdominal retractor; 45×75 mm; 24,0 cm	89
118 91 0229	Fritsch hák břišní; 45×85 mm; 24,0 cm	Fritsch abdominal retractor; 45×85 mm; 24,0 cm	89
118 91 0230	Kocher hák břišní; 70×25 mm; 22,0 cm	Kocher abdominal retractor; 70×25 mm; 22,0 cm	90
118 91 0233	Kocher hák břišní; 80×60 mm; 25,0 cm	Kocher abdominal retractor; 80×60 mm; 25,0 cm	90
118 91 0242	Harrington hák břišní; 127×40 mm; 32,0 cm	Harrington abdominal retractor; 127×40 mm; 32,0 cm	90
118 91 0243	Harrington hák břišní; 127×62 mm; 32,0 cm	Harrington abdominal retractor; 127×62 mm; 32,0 cm	90
118 91 0244	Harrington hák břišní; 175×64 mm; 32,0 cm	Harrington abdominal retractor; 175×64 mm; 32,0 cm	90
118 91 0246	Mikulicz hák břišní; 85×35 mm; 26,0 cm	Mikulicz abdominal retractor; 85×35 mm; 26,0 cm	90
118 91 0247	Mikulicz hák břišní; 120×50 mm; 26,0 cm	Mikulicz abdominal retractor; 120×50 mm; 26,0 cm	90
118 91 0248	Mikulicz hák břišní; 155×50 mm; 26,0 cm	Mikulicz abdominal retractor; 155×50 mm; 26,0 cm	90
118 91 0249	Kelly hák břišní; 160×38 mm; 27,0 cm	Kelly abdominal retractor; 160×38 mm; 27,0 cm	89
118 91 0250	Kelly hák břišní; 160×57 mm; 27,0 cm	Kelly abdominal retractor; 160×57 mm; 27,0 cm	89
118 91 0251	Kelly hák břišní; 190×38 mm; 27,0 cm	Kelly abdominal retractor; 190×38 mm; 27,0 cm	89
118 91 0252	Kelly hák břišní; 190×57 mm; 27,0 cm	Kelly abdominal retractor; 190×57 mm; 27,0 cm	89
118 91 0317	Braun hák dekapilační; 30,0 cm	Braun decapitation hook; 30,0 cm	91
118 91 0388	Emmet hák na fistuli fig. 1; 22,0 cm	Emmet fistula hook fig. 1; 22,0 cm	92
118 91 0389	Emmet hák na fistuli fig. 2; 22,0 cm	Emmet fistula hook fig. 2; 22,0 cm	92
118 91 0390	Emmet hák na fistuli fig. 3; 22,0 cm	Emmet fistula hook fig. 3; 22,0 cm	92
118 91 0391	Emmet hák na fistuli fig. 4; 22,0 cm	Emmet fistula hook fig. 4; 22,0 cm	92
118 91 0392	Emmet hák na fistuli fig. 5; 22,0 cm	Emmet fistula hook fig. 5; 22,0 cm	92
118 91 0393	Simon hák na fistuli 1 hrot; 22,0 cm	Simon fistula hook; 22,0 cm	92
118 91 0394	Simon hák na fistuli 2 hroty; 22,0 cm	Simon fistula hook; 22,0 cm	92
118 91 0395	Beacham amniotom; 26,0 cm	Beacham amniotome; 26,0 cm	91
119	ROZVĚRAČE	RETRACTORS	
119 08 0250	Gosset rozvěrač břišní	Gosset abdominal retractor	94
119 08 0260	Collin rozvěrač břišní	Collin abdominal retractor	93
119 91 0118	Gosset rozvěrač břišní	Gosset abdominal retractor	93
119 91 0119	Gosset rozvěrač břišní	Gosset abdominal retractor	93
119 91 0123	Balfour-Baby rozvěrač břišní	Balfour-baby abdominal retractor	97
119 91 0124	Balfour rozvěrač břišní	Balfour abdominal retractor	94

číslo – number	název	item	strana – page
119 91 0125	Balfour rozvěrač břišní	Balfour abdominal retractor	94
119 91 0126	Balfour rozvěrač břišní	Balfour abdominal retractor	94
119 91 0134	O'Sullivan-O'Connor rozvěrač břišní	O'Sullivan-O'Connor abdominal retractor	96
119 91 0135	O'Sullivan-O'Connor rozvěrač břišní	O'Sullivan-O'Connor abdominal retractor	96
119 91 0136	O'Sullivan-O'Connor rozvěrač břišní	O'Sullivan-O'Connor abdominal retractor	96
119 91 0137	O'Sullivan-O'Connor rozvěrač břišní	O'Sullivan-O'Connor abdominal retractor	96
119 91 0142	Franz rozvěrač břišní komplet	Franz abdominal retractor complete	95
119 91 0143	Franz rozvěrač břišní	Franz abdominal retractor	95
119 91 0144	Lopatka k rozvěrači břišnímu Franz	Blade for abdominal retractor Franz	95
119 91 0145	Lopatka k rozvěrači břišnímu Franz	Blade for abdominal retractor Franz	95
119 91 0146	Lopatka k rozvěrači břišnímu Franz	Blade for abdominal retractor Franz	95
119 91 0147	Lopatka k rozvěrači břišnímu Franz	Blade for abdominal retractor Franz	95
119 91 0148	Lopatka k rozvěrači břišnímu Franz	Blade for abdominal retractor Franz	95
119 91 0149	Lopatka k rozvěrači břišnímu Franz	Blade for abdominal retractor Franz	95
119 91 0150	Lopatka k rozvěrači břišnímu Franz	Blade for abdominal retractor Franz	95
119 91 0151	Kirschner rozvěrač břišní	Kirschner abdominal retractor	96
119 91 0152	Lopatka k rozvěrači břišnímu Kirschner	Blade for abdominal retractor Kirschner	96
119 91 0153	Lopatka k rozvěrači břišnímu Kirschner	Blade for abdominal retractor Kirschner	96
119 91 0154	Lopatka k rozvěrači břišnímu Kirschner	Blade for abdominal retractor Kirschner	96
119 91 0155	Lopatka k rozvěrači břišnímu Kirschner	Blade for abdominal retractor Kirschner	96
119 91 0156	Lopatka k rozvěrači břišnímu Kirschner	Blade for abdominal retractor Kirschner	96
119 91 0164	Collin-Baby rozvěrač břišní	Collin-Baby abdominal retractor	97
119 91 0165	Lopatka k rozvěrači Collin-Baby	Blade for abdominal retractor Collin-Baby	97
119 91 0166	Lopatka k rozvěrači Collin-Baby	Blade for abdominal retractor Collin-Baby	97
119 91 0167	Friedman rozvěrač; 10,0 cm	Friedman retractor	98
119 91 0169	Collin rozvěrač břišní; 22,0 cm	Collin abdominal retractor	98
119 91 0170	Collin rozvěrač břišní	Collin abdominal retractor	98
119 91 0173	Ricard rozvěrač břišní	Ricard abdominal retractor	98
119 91 0174	Ricard rozvěrač břišní	Ricard abdominal retractor	98
119 91 0280	Rozvěrač břišní řetízkový; 20,0 cm	Chainal abdominal retractor; 20,0 cm	97
119 91 0281	Rozvěrač břišní řetízkový; 20,0 cm	Chainal abdominal retractor; 20,0 cm	97
119 91 0282	Rozvěrač břišní řetízkový; 20,0 cm	Chainal abdominal retractor; 20,0 cm	97
121	LOPATKY	SPATULAS	
121 08 0050	Lopatka břišní	Abdominal spatula	99
122	ZRCADLA	SPECULA	
122 27 0350	Páka poševní postranní; 45°; 20 mm; 23,8 cm	Vaginal elevator; 45°; 20 mm; 23,8 cm	100
122 27 0370	Páka poševní postranní; 45°; 30 mm; 24,0 cm	Vaginal elevator; 45°; 30 mm; 24,0 cm	100
122 27 0380	Páka poševní postranní; 45°; 35 mm; 23,5 cm	Vaginal elevator; 45°; 35 mm; 23,5 cm	100
122 27 0400	Páka poševní postranní; 45°; 45 mm; 23,5 cm	Vaginal elevator; 45°; 45 mm; 23,5 cm	100
122 27 0420	Páka poševní postranní; 90°; 20 mm; 16,9 cm	Vaginal elevator; 90°; 20 mm; 16,9 cm	100
122 27 0440	Páka poševní postranní; 90°; 30 mm; 16,9 cm	Vaginal elevator; 90°; 30 mm; 16,9 cm	100
122 27 0450	Páka poševní postranní; 90°; 35 mm; 16,9 cm	Vaginal elevator; 90°; 35 mm; 16,9 cm	101
122 27 0470	Páka poševní postranní; 90°; 45 mm; 16,9 cm	Vaginal elevator; 90°; 45 mm; 16,9 cm	101
122 27 0490	Kristeller zrcadlo poševní sada	Kristeller vaginal speculum set	101
122 91 0001	Cusco zrcadlo poševní; 75×32 mm	Cusco vaginal speculum; 75×32 mm	106
122 91 0002	Cusco zrcadlo poševní; 85×35 mm	Cusco vaginal speculum; 85×35 mm	106
122 91 0003	Cusco zrcadlo poševní; 100×35 mm	Cusco vaginal speculum; 100×35 mm	106
122 91 0004	Cusco-Virgin zrcadlo poševní; 75×17 mm	Cusco-Virgin vaginal speculum; 75×17 mm	106
122 91 0005	Cusco-Suisse zrcadlo poševní; 80×22 mm	Cusco-Suisse vaginal speculum; 80×22 mm	106
122 91 0006	Cusco-Suisse zrcadlo poševní; 100×25 mm	Cusco-Suisse vaginal speculum; 100×25 mm	106
122 91 0007	Cusco-Suisse zrcadlo poševní; 105×27 mm	Cusco-Suisse vaginal speculum; 105×27 mm	106
122 91 0008	Cusco zrcadlo poševní; 74×32 mm	Cusco vaginal speculum; 74×32 mm	106
122 91 0009	Cusco zrcadlo poševní; 85×35 mm	Cusco vaginal speculum; 85×35 mm	106
122 91 0010	Cusco zrcadlo poševní; 100×37 mm	Cusco vaginal speculum; 100×37 mm	106
122 91 0011	Collin zrcadlo poševní; 85×30 mm	Collin vaginal speculum; 85×30 mm	107
122 91 0012	Collin zrcadlo poševní; 100×35 mm	Collin vaginal speculum; 100×35 mm	107
122 91 0013	Collin zrcadlo poševní; 110×40 mm	Collin vaginal speculum; 110×40 mm	107
122 91 0014	Pederson zrcadlo poševní; 75×13 mm	Pederson vaginal speculum; 75×13 mm	107
122 91 0015	Pederson zrcadlo poševní; 100×22 mm	Pederson vaginal speculum; 100×22 mm	107
122 91 0016	Pederson zrcadlo poševní; 120×25 mm	Pederson vaginal speculum; 120×25 mm	107
122 91 0017	Grave zrcadlo poševní; 75×20 mm	Grave vaginal speculum; 75×20 mm	107
122 91 0018	Grave zrcadlo poševní; 95×35 mm	Grave vaginal speculum; 95×35 mm	107
122 91 0019	Grave zrcadlo poševní; 115×35 mm	Grave vaginal speculum; 115×35 mm	107
122 91 0020	Nott zrcadlo poševní; 90×30 mm	Nott vaginal speculum; 90×30 mm	107
122 91 0021	Nott zrcadlo poševní; 110×30 mm	Nott vaginal speculum; 110×30 mm	107
122 91 0022	Semm zrcadlo poševní; 90×14/18 mm	Semm vaginal speculum; 90×14/18 mm	108
122 91 0023	Semm zrcadlo poševní; 100×17/20 mm	Semm vaginal speculum; 100×17/20 mm	108
122 91 0024	Semm zrcadlo poševní; 100×25/30 mm	Semm vaginal speculum; 100×25/30 mm	108
122 91 0025	Seyffert zrcadlo poševní; 100×17 mm	Seyffert vaginal speculum; 100×17 mm	108
122 91 0026	Seyffert zrcadlo poševní; 110×33 mm	Seyffert vaginal speculum; 110×33 mm	108

číslo – number	název	item	strana – page
122 91 0027	Seyffert zrcadlo poševní; 110×33 mm	Seyffert vaginal speculum; 110×33 mm	108
122 91 0028	Grave zrcadlo vaginální s trubičkou; 76×13 mm	Grave vaginal speculum with suction tube; 76×13 mm	109
122 91 0030	Grave zrcadlo vaginální s trubičkou; 101×22 mm	Grave vaginal speculum with suction tube; 101×22 mm	109
122 91 0032	Grave zrcadlo vaginální s trubičkou; 120×35 mm	Grave vaginal speculum with suction tube; 120×35 mm	109
122 91 0034	Grave zrcadlo vaginální s trubičkou; 76×13 mm	Grave vaginal speculum with suction tube; 76×13 mm	109
122 91 0036	Grave zrcadlo vaginální s trubičkou; 101×22 mm	Grave vaginal speculum with suction tube; 101×22 mm	109
122 91 0038	Grave zrcadlo vaginální s trubičkou; 120×35 mm	Grave vaginal speculum with suction tube; 120×35 mm	109
122 91 0040	Grave zrcadlo vaginální s trubičkou; 76×13 mm	Grave vaginal speculum with suction tube; 76×13 mm	109
122 91 0042	Grave zrcadlo vaginální s trubičkou; 101×22 mm	Grave vaginal speculum with suction tube; 101×22 mm	109
122 91 0044	Grave zrcadlo vaginální s trubičkou; 120×35 mm	Grave vaginal speculum with suction tube; 120×35 mm	109
122 91 0046	Grave special zrcadlo se sací trubičkou; 135°	Grave special vaginal speculum with suction tube; 135°	110
122 91 0048	Grave special zrcadlo se sací trubičkou	Grave special vaginal speculum with suction tube	110
122 91 0050	Grave special zrcadlo se sací trubičkou; 135°	Grave special vaginal speculum with suction tube; 135°	110
122 91 0052	Grave special zrcadlo se sací trubičkou; 135°	Grave special vaginal speculum with suction tube; 135°	110
122 91 0054	Grave special zrcadlo se sací trubičkou	Grave special vaginal speculum with suction tube	110
122 91 0056	Grave special zrcadlo se sací trubičkou; 135°	Grave special vaginal speculum with suction tube; 135°	110
122 91 0058	Grave special zrcadlo se sací trubičkou; 135°	Grave special vaginal speculum with suction tube; 135°	110
122 91 0060	Grave special zrcadlo se sací trubičkou	Grave special vaginal speculum with suction tube	110
122 91 0062	Grave special zrcadlo se sací trubičkou; 135°	Grave special vaginal speculum with suction tube; 135°	110
122 91 0064	Pederson zrcadlo se sací trubičkou; 76×13 mm	Pederson vaginal speculum with suction tube; 76×13 mm	111
122 91 0066	Pederson zrcadlo se sací trubičkou; 101×22 mm	Pederson vaginal speculum with suction tube; 101×22 mm	111
122 91 0068	Pederson zrcadlo se sací trubičkou; 120×25 mm	Pederson vaginal speculum with suction tube; 120×25 mm	111
122 91 0070	Pederson zrcadlo se sací trubičkou; 76×13 mm	Pederson vaginal speculum with suction tube; 76×13 mm	111
122 91 0072	Pederson zrcadlo se sací trubičkou; 101×22 mm	Pederson vaginal speculum with suction tube; 101×22 mm	111
122 91 0074	Pederson zrcadlo se sací trubičkou; 120×25 mm	Pederson vaginal speculum with suction tube; 120×25 mm	111
122 91 0076	Pederson zrcadlo se sací trubičkou; 76×13 mm	Pederson vaginal speculum with suction tube; 76×13 mm	111
122 91 0078	Pederson zrcadlo se sací trubičkou; 101×22 mm	Pederson vaginal speculum with suction tube; 101×22 mm	111
122 91 0080	Pederson zrcadlo se sací trubičkou; 120×25 mm	Pederson vaginal speculum with suction tube; 120×25 mm	111
122 91 0082	Cusco zrcadlo se sací trubičkou; 105×25 mm	Cusco vaginal speculum with suction tube; 105×25 mm	111
122 91 0083	Cusco zrcadlo se sací trubičkou; 107×29 mm	Cusco vaginal speculum with suction tube; 107×29 mm	111
122 91 0084	Cusco zrcadlo se sací trubičkou; 115×35 mm	Cusco vaginal speculum with suction tube; 115×35 mm	111
122 91 0085	Cusco zrcadlo se sací trubičkou; 105×25 mm	Cusco vaginal speculum with suction tube; 105×25 mm	111
122 91 0086	Cusco zrcadlo se sací trubičkou; 107×29 mm	Cusco vaginal speculum with suction tube; 107×29 mm	111
122 91 0087	Cusco zrcadlo se sací trubičkou; 115×35 mm	Cusco vaginal speculum with suction tube; 115×35 mm	111
122 91 0088	Cusco zrcadlo se sací trubičkou; 105×25 mm	Cusco vaginal speculum with suction tube; 105×25 mm	111
122 91 0089	Cusco zrcadlo se sací trubičkou; 107×29 mm	Cusco vaginal speculum with suction tube; 107×29 mm	111
122 91 0090	Cusco zrcadlo se sací trubičkou; 115×35 mm	Cusco vaginal speculum with suction tube; 115×35 mm	111
122 91 0091	Sims zrcadlo poševní dvojité; 60×25/30 mm	Sims vaginal speculum - double; 60×25/30 mm	103
122 91 0092	Sims zrcadlo poševní dvojité; 70×30/35 mm	Sims vaginal speculum - double; 70×30/35 mm	103
122 91 0093	Sims zrcadlo poševní dvojité; 80×35/40 mm	Sims vaginal speculum - double; 80×35/40 mm	103
122 91 0094	Kristeller zrcadlo poševní fig. 1; 70×27 mm	Kristeller vaginal speculum fig. 1; 70×27 mm	102
122 91 0095	Kristeller zrcadlo poševní fig. 2; 80×30 mm	Kristeller vaginal speculum fig. 2; 80×30 mm	102
122 91 0096	Kristeller zrcadlo poševní fig. 3; 90×36 mm	Kristeller vaginal speculum fig. 3; 90×36 mm	102
122 91 0097	Kristeller zrcadlo poševní fig. 1; 75×23 mm	Kristeller vaginal speculum fig. 1; 75×23 mm	102
122 91 0098	Kristeller zrcadlo poševní fig. 2; 85×26 mm	Kristeller vaginal speculum fig. 2; 85×26 mm	102
122 91 0099	Kristeller zrcadlo poševní fig. 3; 100×32 mm	Kristeller vaginal speculum fig. 3; 100×32 mm	102
122 91 0100	Kristeller zrcadlo poševní sada fig. 1	Kristeller vaginal speculum set fig. 1	102
122 91 0101	Kristeller zrcadlo poševní sada fig. 2	Kristeller vaginal speculum set fig. 2	102
122 91 0102	Kristeller zrcadlo poševní sada fig. 3	Kristeller vaginal speculum set fig. 3	102
122 91 0103	Kristeller zrcadlo poševní fig. 00; 105×18 mm	Kristeller vaginal speculum fig. 00; 105×18 mm	102
122 91 0104	Kristeller zrcadlo poševní fig. 0; 105×21 mm	Kristeller vaginal speculum fig. 0; 105×21 mm	102
122 91 0105	Kristeller zrcadlo poševní fig. 00; 110×14 mm	Kristeller vaginal speculum fig. 00; 110×14 mm	102
122 91 0106	Kristeller zrcadlo poševní fig. 0; 110×17 mm	Kristeller vaginal speculum fig. 0; 110×17 mm	102
122 91 0107	Kristeller zrcadlo poševní sada fig. 00	Kristeller vaginal speculum set fig. 00	102
122 91 0108	Kristeller zrcadlo poševní sada fig. 0	Kristeller vaginal speculum set fig. 0	102
122 91 0109	Kristeller zrcadlo poševní fig. 1; 105×26 mm	Kristeller vaginal speculum fig. 1; 105×26 mm	102
122 91 0110	Kristeller zrcadlo poševní fig. 2; 105×28 mm	Kristeller vaginal speculum fig. 2; 105×28 mm	102
122 91 0111	Kristeller zrcadlo poševní fig. 3; 105×33 mm	Kristeller vaginal speculum fig. 3; 105×33 mm	102
122 91 0112	Kristeller zrcadlo poševní fig. 1; 115×22 mm	Kristeller vaginal speculum fig. 1; 115×22 mm	102
122 91 0113	Kristeller zrcadlo poševní fig. 2; 115×24 mm	Kristeller vaginal speculum fig. 2; 115×24 mm	102
122 91 0114	Kristeller zrcadlo poševní fig. 3; 115×29 mm	Kristeller vaginal speculum fig. 3; 115×29 mm	102
122 91 0115	Kristeller zrcadlo poševní sada fig. 1	Kristeller vaginal speculum set fig. 1	102
122 91 0116	Kristeller zrcadlo poševní sada fig. 2	Kristeller vaginal speculum set fig. 2	102
122 91 0117	Kristeller zrcadlo poševní sada fig. 3	Kristeller vaginal speculum set fig. 3	102
122 91 0118	Kristeller zrcadlo poševní fig. 1; 110×27 mm	Kristeller vaginal speculum fig. 1; 110×27 mm	102
122 91 0119	Kristeller zrcadlo poševní fig. 2; 110×30 mm	Kristeller vaginal speculum fig. 2; 110×30 mm	102
122 91 0120	Kristeller zrcadlo poševní fig. 3; 110×36 mm	Kristeller vaginal speculum fig. 3; 110×36 mm	102
122 91 0121	Kristeller zrcadlo poševní fig. 1; 115×23 mm	Kristeller vaginal speculum fig. 1; 115×23 mm	102
122 91 0122	Kristeller zrcadlo poševní fig. 2; 115×26 mm	Kristeller vaginal speculum fig. 2; 115×26 mm	102
122 91 0123	Kristeller zrcadlo poševní fig. 3; 115×32 mm	Kristeller vaginal speculum fig. 3; 115×32 mm	102

číslo – number	název	item	strana – page
122 91 0124	Kristeller zrcadlo poševní sada fig. 1	Kristeller vaginal speculum set fig. 1	102
122 91 0125	Kristeller zrcadlo poševní sada fig. 2	Kristeller vaginal speculum set fig. 2	102
122 91 0126	Kristeller zrcadlo poševní sada fig. 3	Kristeller vaginal speculum set fig. 3	102
122 91 0127	Doyen zrcadlo poševní; 55×35 mm	Doayne vaginal speculum; 55×35 mm	104
122 91 0128	Doyen zrcadlo poševní; 85×35 mm	Doayne vaginal speculum; 85×35 mm	104
122 91 0129	Doyen zrcadlo poševní; 115×35 mm	Doayne vaginal speculum; 115×35 mm	104
122 91 0130	Doyen zrcadlo poševní; 55×45 mm	Doayne vaginal speculum; 55×45 mm	104
122 91 0131	Doyen zrcadlo poševní; 85×45 mm	Doayne vaginal speculum; 85×45 mm	104
122 91 0132	Doyen zrcadlo poševní; 115×45 mm	Doayne vaginal speculum; 115×45 mm	104
122 91 0133	Doyen zrcadlo poševní; 55×60 mm	Doayne vaginal speculum; 55×60 mm	104
122 91 0134	Doyen zrcadlo poševní; 85×60 mm	Doayne vaginal speculum; 85×60 mm	104
122 91 0135	Doyen zrcadlo poševní; 115×60 mm	Doayne vaginal speculum; 115×60 mm	104
122 91 0136	Scherback zrcadlo poševní komplet	Scherback vaginal speculum complete	104
122 91 0137	Lžice pro zrcadlo Scherback	Blade for speculum Scherback	104
122 91 0138	Lžice pro zrcadlo Scherback	Blade for speculum Scherback	104
122 91 0139	Lžice pro zrcadlo Scherback	Blade for speculum Scherback	104
122 91 0140	Lžice pro zrcadlo Scherback	Blade for speculum Scherback	104
122 91 0141	Lžice pro zrcadlo Scherback	Blade for speculum Scherback	104
122 91 0142	Držadlo pro zrcadlo Scherback	Handle for vaginal speculum Scherback	104
122 91 0143	Závaží pro zrcadlo Scherback; 400 g	Weight for vaginal speculum 400 g	104
122 91 0144	Závaží pro zrcadlo Scherback; 800 g	Weight for vaginal speculum 800 g	104
122 91 0145	Scherback zrcadlo poševní komplet	Scherback vaginal speculum complete	104
122 91 0146	Auvarđ zrcadlo poševní; 80×38 mm	Auvarđ vaginal speculum; 80×38 mm	105
122 91 0147	Auvarđ zrcadlo poševní; 102×45 mm	Auvarđ vaginal speculum; 102×45 mm	105
122 91 0148	New port páka laterální poševní; 25,0 cm	New port vaginal retractor; 25,0 cm	113
122 91 0149	Breisky zrcadlo poševní bajonetové; 100×20 mm	Breisky vaginal speculum; 100×20 mm	105
122 91 0150	Breisky zrcadlo poševní bajonetové; 100×25 mm	Breisky vaginal speculum; 100×25 mm	105
122 91 0151	Breisky zrcadlo poševní bajonetové; 100×30 mm	Breisky vaginal speculum; 100×30 mm	105
122 91 0152	Breisky zrcadlo poševní bajonetové; 100×35 mm	Breisky vaginal speculum; 100×35 mm	105
122 91 0153	Breisky zrcadlo poševní bajonetové; 100×40 mm	Breisky vaginal speculum; 100×40 mm	105
122 91 0154	Breisky zrcadlo poševní bajonetové; 130×20 mm	Breisky vaginal speculum; 130×20 mm	105
122 91 0155	Breisky zrcadlo poševní bajonetové; 130×25 mm	Breisky vaginal speculum; 130×25 mm	105
122 91 0156	Breisky zrcadlo poševní bajonetové; 130×30 mm	Breisky vaginal speculum; 130×30 mm	105
122 91 0157	Breisky zrcadlo poševní bajonetové; 130×35 mm	Breisky vaginal speculum; 130×35 mm	105
122 91 0158	Breisky zrcadlo poševní bajonetové; 130×40 mm	Breisky vaginal speculum; 130×40 mm	105
122 91 0159	Breisky zrcadlo poševní bajonetové; 155×40 mm	Breisky vaginal speculum; 155×40 mm	105
122 91 0160	Landau zrcadlo poševní bajonetové; 105×28 mm	Landau vaginal speculum; 105×28 mm	105
122 91 0161	Landau zrcadlo poševní bajonetové; 105×38 mm	Landau vaginal speculum; 105×38 mm	105
122 91 0162	O'Sullivan-O'Connor rozvěrač komplet	O'Sullivan-O'Connor retractor complete	113
122 91 0163	Rám pro O'Sullivan-O'Connor	Frame for retractor O'Sullivan-O'Connor	113
122 91 0164	Lopatka pro O'Sullivan-O'Connor; 45×17 mm	Blade for retractor O'Sullivan-O'Connor; 45×17 mm	113
122 91 0165	Lopatka pro O'Sullivan-O'Connor; 90×37 mm	Blade for retractor O'Sullivan-O'Connor; 90×37 mm	113
122 91 0166	Lopatka pro O'Sullivan-O'Connor; 90×45 mm	Blade for retractor O'Sullivan-O'Connor; 90×45 mm	113
122 91 0168	Kogan endozrcadlo; 24,0 cm	Kogan endospeculum; 24,0 cm	112
122 91 0169	Kogan endozrcadlo se západkou; 24,0 cm	Kogan endospeculum; 24,0 cm	112
122 91 0170	Kogan endozrcadlo 3 mm; 24,0 cm	Kogan endospeculum 3 mm; 24,0 cm	112
122 91 0171	Kogan endozrcadlo 7 mm; 24,0 cm	Kogan endospeculum 7 mm; 24,0 cm	112
124	ŠKRABKY	RASPATORIES	
124 27 0011	Ayer škrabka děložní; 22,0 cm	Ayer uterina raspatorium; 22,0 cm	114
125	LŽIČKY	SPOONS	
125 27 0050	Lžička děložní oválná 7×10 mm; 30 cm	Uterina spoon 7×10 mm; 30 cm	115
125 27 0060	Lžička děložní oválná 12×18 mm; 30 cm	Uterina spoon 12×18 mm; 30 cm	115
125 27 0070	Recamier lžička děložní fig. 1	Recaimier uterine spoon fig. 1	115
125 27 0080	Recamier lžička děložní fig. 2	Recaimier uterine spoon fig. 2	115
125 27 0090	Recamier lžička děložní fig. 3	Recaimier uterine spoon fig. 3	115
125 27 0100	Recamier lžička děložní fig. 4	Recaimier uterine spoon fig. 4	115
125 27 0110	Recamier lžička děložní fig. 5	Recaimier uterine spoon fig. 5	115
125 27 0120	Recamier lžička děložní fig. 6	Recaimier uterine spoon fig. 6	115
125 91 0001	Simon/Schröder lžice děložní fig. 1; 25 cm	Simon/Schröder uterine scoop fig. 1; 25 cm	116
125 91 0002	Simon/Schröder lžice děložní fig. 2; 25 cm	Simon/Schröder uterine scoop fig. 2; 25 cm	116
125 91 0003	Simon/Schröder lžice děložní fig. 3; 25 cm	Simon/Schröder uterine scoop fig. 3; 25 cm	116
125 91 0004	Simon/Schröder lžice děložní fig. 4; 25 cm	Simon/Schröder uterine scoop fig. 4; 25 cm	116
125 91 0005	Simon/Schröder lžice děložní fig. 5; 25 cm	Simon/Schröder uterine scoop fig. 5; 25 cm	116
125 91 0006	Simon/Schröder lžice děložní fig. 6; 25 cm	Simon/Schröder uterine scoop fig. 6; 25 cm	116
125 91 0007	Simon/Schröder lžice děložní fig. 1; 30 cm	Simon/Schröder uterine scoop fig. 1; 30 cm	116
125 91 0008	Simon/Schröder lžice děložní fig. 2; 30 cm	Simon/Schröder uterine scoop fig. 2; 30 cm	116
125 91 0009	Simon/Schröder lžice děložní fig. 3; 30 cm	Simon/Schröder uterine scoop fig. 3; 30 cm	116
125 91 0010	Simon/Schröder lžice děložní fig. 4; 30 cm	Simon/Schröder uterine scoop fig. 4; 30 cm	116
125 91 0011	Simon/Schröder lžice děložní fig. 5; 30 cm	Simon/Schröder uterine scoop fig. 5; 30 cm	116
125 91 0012	Simon/Schröder lžice děložní fig. 6; 30 cm	Simon/Schröder uterine scoop fig. 6; 30 cm	116

číslo – number	název	item	strana – page
125 91 0013	Gourdet lžice děložní fig. 1; 28,0 cm	Gourdet uterine scoop fig. 1; 28,0 cm	116
125 91 0014	Gourdet lžice děložní fig. 2; 28,0 cm	Gourdet uterine scoop fig. 2; 28,0 cm	116
125 91 0015	Gourdet lžice děložní fig. 3; 28,0 cm	Gourdet uterine scoop fig. 3; 28,0 cm	116
125 91 0016	Gourdet lžice děložní fig. 4; 28,0 cm	Gourdet uterine scoop fig. 4; 28,0 cm	116
125 91 0017	Gourdet lžice děložní fig. 5; 28,0 cm	Gourdet uterine scoop fig. 5; 28,0 cm	116
125 91 0018	Wallich lžice děložní; 42,0 cm	Wallich uterine scoop; 42,0 cm	117
126	KYRETY	CURETTES	
126 27 0010	Kyreta děložní ostrá neohebná fig. 1	Uterine curette sharp fig. 1	120
126 27 0011	Kyreta děložní ostrá neohebná fig. 1	Uterine curette sharp fig. 1	120
126 27 0012	Kyreta děložní ostrá neohebná fig. 1	Uterine curette sharp fig. 1	120
126 27 0020	Kyreta děložní ostrá neohebná fig. 2	Uterine curette sharp fig. 2	120
126 27 0021	Kyreta děložní ostrá neohebná fig. 2	Uterine curette sharp fig. 2	120
126 27 0022	Kyreta děložní ostrá neohebná fig. 2	Uterine curette sharp fig. 2	120
126 27 0030	Kyreta děložní ostrá neohebná fig. 3	Uterine curette sharp fig. 3	120
126 27 0031	Kyreta děložní ostrá neohebná fig. 3	Uterine curette sharp fig. 3	120
126 27 0032	Kyreta děložní ostrá neohebná fig. 3	Uterine curette sharp fig. 3	120
126 27 0040	Kyreta děložní ostrá neohebná fig. 4	Uterine curette sharp fig. 4	120
126 27 0041	Kyreta děložní ostrá neohebná fig. 4	Uterine curette sharp fig. 4	120
126 27 0042	Kyreta děložní ostrá neohebná fig. 4	Uterine curette sharp fig. 4	120
126 27 0050	Kyreta děložní ostrá neohebná fig. 5	Uterine curette sharp fig. 5	120
126 27 0051	Kyreta děložní ostrá neohebná fig. 5	Uterine curette sharp fig. 5	120
126 27 0052	Kyreta děložní ostrá neohebná fig. 5	Uterine curette sharp fig. 5	120
126 27 0060	Kyreta děložní ostrá neohebná fig. 6	Uterine curette sharp fig. 6	120
126 27 0061	Kyreta děložní ostrá neohebná fig. 6	Uterine curette sharp fig. 6	120
126 27 0062	Kyreta děložní ostrá neohebná fig. 6	Uterine curette sharp fig. 6	120
126 27 0070	Kyreta děložní ostrá neohebná fig. 7	Uterine curette sharp fig. 7	120
126 27 0071	Kyreta děložní ostrá neohebná fig. 7	Uterine curette sharp fig. 7	120
126 27 0072	Kyreta děložní ostrá neohebná fig. 7	Uterine curette sharp fig. 7	120
126 27 0080	Kyreta děložní ostrá neohebná fig. 8	Uterine curette sharp fig. 8	120
126 27 0081	Kyreta děložní ostrá neohebná fig. 8	Uterine curette sharp fig. 8	120
126 27 0082	Kyreta děložní ostrá neohebná fig. 8	Uterine curette sharp fig. 8	120
126 27 0110	Kyreta děložní tupá neohebná fig. 1	Uterine curette blunt fig. 1	121
126 27 0111	Kyreta děložní tupá neohebná fig. 1	Uterine curette blunt fig. 1	121
126 27 0112	Kyreta děložní tupá neohebná fig. 1	Uterine curette blunt fig. 1	121
126 27 0120	Kyreta děložní tupá neohebná fig. 2	Uterine curette blunt fig. 2	121
126 27 0121	Kyreta děložní tupá neohebná fig. 2	Uterine curette blunt fig. 2	121
126 27 0122	Kyreta děložní tupá neohebná fig. 2	Uterine curette blunt fig. 2	121
126 27 0130	Kyreta děložní tupá neohebná fig. 3	Uterine curette blunt fig. 3	121
126 27 0131	Kyreta děložní tupá neohebná fig. 3	Uterine curette blunt fig. 3	121
126 27 0132	Kyreta děložní tupá neohebná fig. 3	Uterine curette blunt fig. 3	121
126 27 0140	Kyreta děložní tupá neohebná fig. 4	Uterine curette blunt fig. 4	121
126 27 0141	Kyreta děložní tupá neohebná fig. 4	Uterine curette blunt fig. 4	121
126 27 0142	Kyreta děložní tupá neohebná fig. 4	Uterine curette blunt fig. 4	121
126 27 0150	Kyreta děložní tupá neohebná fig. 5	Uterine curette blunt fig. 5	121
126 27 0151	Kyreta děložní tupá neohebná fig. 5	Uterine curette blunt fig. 5	121
126 27 0152	Kyreta děložní tupá neohebná fig. 5	Uterine curette blunt fig. 5	121
126 27 0160	Kyreta děložní tupá neohebná fig. 6	Uterine curette blunt fig. 6	121
126 27 0161	Kyreta děložní tupá neohebná fig. 6	Uterine curette blunt fig. 6	121
126 27 0162	Kyreta děložní tupá neohebná fig. 6	Uterine curette blunt fig. 6	121
126 27 0170	Kyreta děložní tupá neohebná fig. 7	Uterine curette blunt fig. 7	121
126 27 0171	Kyreta děložní tupá neohebná fig. 7	Uterine curette blunt fig. 7	121
126 27 0172	Kyreta děložní tupá neohebná fig. 7	Uterine curette blunt fig. 7	121
126 27 0180	Kyreta děložní tupá neohebná fig. 8	Uterine curette blunt fig. 8	121
126 27 0181	Kyreta děložní tupá neohebná fig. 8	Uterine curette blunt fig. 8	121
126 27 0182	Kyreta děložní tupá neohebná fig. 8	Uterine curette blunt fig. 8	121
126 27 0641	Bumm kyreta děložní	Bumm uterine curette	119
126 27 0691	Bumm kyreta děložní	Bumm uterine curette	119
126 91 0021	Milan kyreta na biopsii; 4 mm; 28,0 cm	Milan biopsy curette; 28,0 cm	124
126 91 0022	Milan kyreta na biopsii; 6 mm; 28,0 cm	Milan biopsy curette; 28,0 cm	124
126 91 0023	Milan kyreta na biopsii; 9 mm; 28,0 cm	Milan biopsy curette; 28,0 cm	124
126 91 0024	Spojka pro aspirační kyretu	Connector for aspirating curette	124
126 91 0025	Kyreta aspirační; 3,0 mm	Aspirating curette; 3,0 mm	124
126 91 0026	Kyreta aspirační; 4,5 mm	Aspirating curette; 4,5 mm	124
126 91 0027	Kyreta aspirační; 6,0 mm	Aspirating curette; 6,0 mm	124
126 91 0028	Kyreta aspirační; 8,0 mm	Aspirating curette; 8,0 mm	124
126 91 0029	Kyreta aspirační; 10,0 mm	Aspirating curette; 10,0 mm	124
126 91 0030	Kyreta aspirační; 12,0 mm	Aspirating curette; 12,0 mm	124
126 91 0031	Kyreta aspirační; 14,0 mm	Aspirating curette; 14,0 mm	124
126 91 0032	Recamier/Sims kyreta ostrá ohebná; 5 mm; 31 cm	Recamier/Sims uterine curette sharp fig. 00; 5 mm; 31 cm	122
126 91 0033	Recamier/Sims kyreta ostrá ohebná; 6 mm; 31 cm	Recamier/Sims uterine curette sharp fig. 0; 6 mm; 31 cm	122

číslo – number	název	item	strana – page
126 91 0034	Recamier/Sims kyreta ostrá ohebná; 7 mm; 31 cm	Recamier/Sims uterine curette sharp fig. 1; 7 mm; 31 cm	122
126 91 0035	Recamier/Sims kyreta ostrá ohebná; 8 mm; 31 cm	Recamier/Sims uterine curette sharp fig. 2; 8 mm; 31 cm	122
126 91 0036	Recamier/Sims kyreta ostrá ohebná; 9 mm; 31 cm	Recamier/Sims uterine curette sharp fig. 3; 9 mm; 31 cm	122
126 91 0037	Recamier/Sims kyreta ostrá ohebná; 11 mm; 31 cm	Recamier/Sims uterine curette sharp fig. 4; 11 mm; 31 cm	122
126 91 0038	Recamier/Sims kyreta ostrá ohebná; 12 mm; 31 cm	Recamier/Sims uterine curette sharp fig. 5; 12 mm; 31 cm	122
126 91 0039	Recamier/Sims kyreta ostrá ohebná; 14 mm; 31 cm	Recamier/Sims uterine curette sharp fig. 6; 14 mm; 31 cm	122
126 91 0040	Recamier/Sims kyreta ostrá ohebná; 15 mm; 31 cm	Recamier/Sims uterine curette sharp fig. 7; 15 mm; 31 cm	122
126 91 0041	Recamier/Sims kyreta ostrá ohebná; 16 mm; 31 cm	Recamier/Sims uterine curette sharp fig. 8; 16 mm; 31 cm	122
126 91 0042	Recamier/Sims kyreta ostrá ohebná; 19 mm; 31 cm	Recamier/Sims uterine curette sharp fig. 9; 19 mm; 31 cm	122
126 91 0043	Recamier/Sims kyreta ostrá ohebná; 20 mm; 31 cm	Recamier/Sims uterine curette sharp fig. 10; 20 mm; 31 cm	122
126 91 0044	Recamier/Sims kyreta ostrá ohebná; 21 mm; 31 cm	Recamier/Sims uterine curette sharp fig. 11; 21 mm; 31 cm	122
126 91 0045	Recamier/Sims kyreta ostrá ohebná; 23 mm; 31 cm	Recamier/Sims uterine curette sharp fig. 12; 23 mm; 31 cm	122
126 91 0046	Recamier/Sims kyreta ostrá ohebná; 5 mm; 26 cm	Recamier/Sims uterine curette sharp fig. 00; 5 mm; 26 cm	122
126 91 0047	Recamier/Sims kyreta ostrá ohebná; 6 mm; 26 cm	Recamier/Sims uterine curette sharp fig. 00; 6 mm; 26 cm	122
126 91 0048	Recamier/Sims kyreta ostrá ohebná; 7 mm; 26 cm	Recamier/Sims uterine curette sharp fig. 1; 7 mm; 26 cm	122
126 91 0049	Recamier/Sims kyreta ostrá ohebná; 8 mm; 26 cm	Recamier/Sims uterine curette sharp fig. 2; 8 mm; 26 cm	122
126 91 0050	Recamier/Sims kyreta ostrá ohebná; 9 mm; 26 cm	Recamier/Sims uterine curette sharp fig. 3; 9 mm; 26 cm	122
126 91 0051	Recamier/Sims kyreta ostrá ohebná; 11 mm; 26 cm	Recamier/Sims uterine curette sharp fig. 4; 11 mm; 26 cm	122
126 91 0052	Recamier/Sims kyreta ostrá ohebná; 12 mm; 26 cm	Recamier/Sims uterine curette sharp fig. 5; 12 mm; 26 cm	122
126 91 0053	Recamier/Sims kyreta ostrá ohebná; 14 mm; 26 cm	Recamier/Sims uterine curette sharp fig. 6; 14 mm; 26 cm	122
126 91 0054	Recamier/Sims kyreta ostrá ohebná; 15 mm; 26 cm	Recamier/Sims uterine curette sharp fig. 7; 15 mm; 26 cm	122
126 91 0055	Recamier/Sims kyreta ostrá ohebná; 16 mm; 26 cm	Recamier/Sims uterine curette sharp fig. 8; 16 mm; 26 cm	122
126 91 0056	Recamier/Sims kyreta ostrá ohebná; 19 mm; 26 cm	Recamier/Sims uterine curette sharp fig. 9; 19 mm; 26 cm	122
126 91 0057	Recamier/Sims kyreta ostrá ohebná; 20 mm; 26 cm	Recamier/Sims uterine curette sharp fig. 10; 20 mm; 26 cm	122
126 91 0058	Recamier/Sims kyreta ostrá ohebná; 21 mm; 26 cm	Recamier/Sims uterine curette sharp fig. 11; 21 mm; 26 cm	122
126 91 0059	Recamier/Sims kyreta ostrá ohebná; 23 mm; 26 cm	Recamier/Sims uterine curette sharp fig. 12; 23 mm; 26 cm	122
126 91 0060	Sims/Recamier kyreta tupá ohebná; 5 mm; 31 cm	Sims/Recamier uterine curette blunt fig. 4; 5 mm; 31 cm	123
126 91 0061	Sims/Recamier kyreta tupá ohebná; 6 mm; 31 cm	Sims/Recamier uterine curette blunt fig. 4; 6 mm; 31 cm	123
126 91 0062	Sims/Recamier kyreta tupá ohebná; 7 mm; 31 cm	Sims/Recamier uterine curette blunt fig. 4; 7 mm; 31 cm	123
126 91 0063	Sims/Recamier kyreta tupá ohebná; 8 mm; 31 cm	Sims/Recamier uterine curette blunt fig. 4; 8 mm; 31 cm	123
126 91 0064	Sims/Recamier kyreta tupá ohebná; 9 mm; 31 cm	Sims/Recamier uterine curette blunt fig. 4; 9 mm; 31 cm	123
126 91 0065	Sims/Recamier kyreta tupá ohebná; 11 mm; 31 cm	Sims/Recamier uterine curette blunt fig. 4; 11 mm; 31 cm	123
126 91 0066	Sims/Recamier kyreta tupá ohebná; 12 mm; 31 cm	Sims/Recamier uterine curette blunt fig. 4; 12 mm; 31 cm	123
126 91 0067	Sims/Recamier kyreta tupá ohebná; 14 mm; 31 cm	Sims/Recamier uterine curette blunt fig. 4; 14 mm; 31 cm	123
126 91 0068	Sims/Recamier kyreta tupá ohebná; 15 mm; 31 cm	Sims/Recamier uterine curette blunt fig. 4; 15 mm; 31 cm	123
126 91 0069	Sims/Recamier kyreta tupá ohebná; 16 mm; 31 cm	Sims/Recamier uterine curette blunt fig. 4; 16 mm; 31 cm	123
126 91 0070	Sims/Recamier kyreta tupá ohebná; 19 mm; 31 cm	Sims/Recamier uterine curette blunt fig. 4; 19 mm; 31 cm	123
126 91 0071	Sims/Recamier kyreta tupá ohebná; 20 mm; 31 cm	Sims/Recamier uterine curette blunt fig. 4; 20 mm; 31 cm	123
126 91 0072	Sims/Recamier kyreta tupá ohebná; 21 mm; 31 cm	Sims/Recamier uterine curette blunt fig. 4; 21 mm; 31 cm	123
126 91 0073	Sims/Recamier kyreta tupá ohebná; 23 mm; 31 cm	Sims/Recamier uterine curette blunt fig. 4; 23 mm; 31 cm	123
126 91 0074	Sims/Recamier kyreta tupá ohebná; 5 mm; 26 cm	Sims/Recamier uterine curette blunt fig. 4; 5 mm; 26 cm	123
126 91 0075	Sims/Recamier kyreta tupá ohebná; 6 mm; 26 cm	Sims/Recamier uterine curette blunt fig. 4; 6 mm; 26 cm	123
126 91 0076	Sims/Recamier kyreta tupá ohebná; 7 mm; 26 cm	Sims/Recamier uterine curette blunt fig. 4; 7 mm; 26 cm	123
126 91 0077	Sims/Recamier kyreta tupá ohebná; 8 mm; 26 cm	Sims/Recamier uterine curette blunt fig. 4; 8 mm; 26 cm	123
126 91 0078	Sims/Recamier kyreta tupá ohebná; 9 mm; 26 cm	Sims/Recamier uterine curette blunt fig. 4; 9 mm; 26 cm	123
126 91 0079	Sims/Recamier kyreta tupá ohebná; 11 mm; 26 cm	Sims/Recamier uterine curette blunt fig. 4; 11 mm; 26 cm	123
126 91 0080	Sims/Recamier kyreta tupá ohebná; 12 mm; 26 cm	Sims/Recamier uterine curette blunt fig. 5; 12 mm; 26 cm	123
126 91 0081	Sims/Recamier kyreta tupá ohebná; 14 mm; 26 cm	Sims/Recamier uterine curette blunt fig. 6; 14 mm; 26 cm	123
126 91 0082	Sims/Recamier kyreta tupá ohebná; 15 mm; 26 cm	Sims/Recamier uterine curette blunt fig. 7; 15 mm; 26 cm	123
126 91 0083	Sims/Recamier kyreta tupá ohebná; 16 mm; 26 cm	Sims/Recamier uterine curette blunt fig. 8; 16 mm; 26 cm	123
126 91 0084	Sims/Recamier kyreta tupá ohebná; 19 mm; 26 cm	Sims/Recamier uterine curette blunt fig. 9; 19 mm; 26 cm	123
126 91 0085	Sims/Recamier kyreta tupá ohebná; 20 mm; 26 cm	Sims/Recamier uterine curette blunt fig. 4; 20 mm; 26 cm	123
126 91 0086	Sims/Recamier kyreta tupá ohebná; 21 mm; 26 cm	Sims/Recamier uterine curette blunt fig. 4; 21 mm; 26 cm	123
126 91 0087	Sims/Recamier kyreta tupá ohebná; 23 mm; 26 cm	Sims/Recamier uterine curette blunt fig. 4; 23 mm; 26 cm	123
126 91 0088	Collin kyreta děložní; 8,0 mm; 28,0 cm	Collin uterine curette; 8,0 mm; 28,0 cm	118
126 91 0089	Collin kyreta děložní; 10,0 mm; 28,0 cm	Collin uterine curette; 10,0 mm; 28,0 cm	118
126 91 0090	Collin kyreta děložní; 12,0 mm; 28,0 cm	Collin uterine curette; 12,0 mm; 28,0 cm	118
126 91 0091	Collin kyreta děložní; 14,0 mm; 28,0 cm	Collin uterine curette; 14,0 mm; 28,0 cm	118
126 91 0092	Blake kyreta děložní ostrá/tupá	Blake uterine curette sharp/blunt	118
126 91 0093	Doyen šroub na myomy; 17,0 cm	Doyen myoma instrument; 17,0 cm	126
126 91 0094	Doyen šroub na myomy; 17,0 cm	Doyen myoma instrument; 17,0 cm	126
126 91 0095	Randal kyreta sací pro biopsii; 24,0 cm	Randal suction biopsy curette; 24,0 cm	125
126 91 0096	Novak kyreta sací pro biopsii; 23,0 cm	Novak suction biopsy curette; 23,0 cm	125
126 91 0097	Novak kyreta sací pro biopsii; 23,0 cm	Novak suction biopsy curette; 23,0 cm	125
126 91 0098	Novak kyreta sací pro biopsii; 23,0 cm	Novak suction biopsy curette; 23,0 cm	125
126 91 0099	Kevorkian kyreta sací pro biopsii; 30,0 cm	Kevorkian suction biopsy curette; 30,0 cm	125
126 91 0163	Kevorkian kyreta sací pro biopsii; 30,0 cm	Kevorkian suction biopsy curette; 30,0 cm	125
132	JEHLY, JEHELCE	NEEDLES, NEEDLE HOLDERS	
132 06 0010	Deschamps jehla podvazovací pravá ostrá fig. 1	Deschamps ligature needle sharp fig. 1	127
132 06 0020	Deschamps jehla podvazovací levá ostrá fig. 1	Deschamps ligature needle sharp fig. 1	127

číslo – number	název	item	strana – page
132 06 0030	Deschamps jehla podvazovací pravá tupá fig. 1	Deschamps ligature needle blunt fig. 1	127
132 06 0040	Deschamps jehla podvazovací levá tupá fig. 1	Deschamps ligature needle blunt fig. 1	127
132 06 0050	Deschamps jehla podvazovací pravá ostrá fig. 2	Deschamps ligature needle sharp fig. 2	127
132 06 0060	Deschamps jehla podvazovací levá ostrá fig. 2	Deschamps ligature needle sharp fig. 2	127
132 06 0070	Deschamps jehla podvazovací pravá tupá fig. 2	Deschamps ligature needle blunt fig. 2	127
132 06 0080	Deschamps jehla podvazovací levá tupá fig. 2	Deschamps ligature needle blunt fig. 2	127
132 06 0090	Deschamps jehla podvazovací pravá ostrá fig. 3	Deschamps ligature needle sharp fig. 3	127
132 06 0100	Deschamps jehla podvazovací levá ostrá fig. 3	Deschamps ligature needle sharp fig. 3	127
132 06 0110	Deschamps jehla podvazovací pravá tupá fig. 3	Deschamps ligature needle blunt fig. 3	127
132 06 0120	Deschamps jehla podvazovací levá tupá fig. 3	Deschamps ligature needle blunt fig. 3	127
132 06 0370	Crile jehelec jemný diamantovaný 1,6 mm; 15,5 cm	Crile needle holder diamond 1,6 mm; 15,5 cm	131
132 06 0450	Crile jehelec jemný tvrdokov; 16,2 cm	Crile needle holder TUC; 16,2 cm	131
132 06 0500	Mathieu jehelec tvrdokov; 17,0 cm	Mathieu needle holder TUC; 17,0 cm	130
132 06 0510	Mathieu jehelec tvrdokov; 21,5 cm	Mathieu needle holder TUC; 21,5 cm	130
132 06 0520	Mathieu jehelec tvrdokov; 14,0 cm	Mathieu needle holder TUC; 14,0 cm	130
132 06 0590	Jehelec jemný rovný tvrdokov; 13,0 cm	Needle holder TUC; 13,0 cm	128
132 06 0610	Jehelec hloubkový rovný tvrdokov; 16,5 cm	Needle holder TUC; 16,5 cm	128
132 06 0620	Jehelec hloubkový rovný tvrdokov; 20,5 cm	Needle holder TUC; 20,5 cm	128
132 06 0630	Jehelec hloubkový rovný tvrdokov; 25,5 cm	Needle holder TUC; 25,5 cm	128
132 06 0710	Bozemann jehelec hloubkový tvrdokov; 16 cm	Bozemann needle holder TUC; 16 cm	128
132 06 0720	Bozemann jehelec hloubkový tvrdokov; 20 cm	Bozemann needle holder TUC; 20 cm	128
132 06 0730	Bozemann jehelec hloubkový tvrdokov; 25 cm	Bozemann needle holder TUC; 25 cm	128
132 06 0740	Jehelec hloubkový prohnutý diamantovaný; 20,0 cm	Needle holder TUC; 20,0 cm	129
132 06 0830	Jehelec s vnitřním uzávěrem tvrdokov; 20,5 cm	Needle holder TUC; 20,5 cm	131
132 08 0500	Redonova jehla 8 Ch; 16,0 cm	Redon needle 8 Ch; 16,0 cm	133
132 08 0510	Redonova jehla 9 Ch; 16,0 cm	Redon needle 9 Ch; 16,0 cm	133
132 08 0520	Redonova jehla 10 Ch; 16,0 cm	Redon needle 10 Ch; 16,0 cm	133
132 91 0148	Finocchetto jehelec tvrdokov; 27,0 cm	Finocchetto needle holder TUC; 27,0 cm	129
132 91 0149	Wangensteen jehelec tvrdokov; 27,0 cm	Wangensteen needle holder TUC; 27,0 cm	129
132 91 0154	Sarot jehelec tvrdokov; 18,0 cm	Sarot needle holder TUC; 18,0 cm	129
132 91 0155	Sarot jehelec tvrdokov; 26,0 cm	Sarot needle holder TUC; 26,0 cm	129
132 91 0156	Masson jehelec tvrdokov; 27,0 cm	Masson needle holder TUC; 27,0 cm	129
132 91 0160	Olsen-Hegar jehelec/nůžky tvrdokov; 14,0 cm	Olsen-Hegar needle holder TUC; 14,0 cm	130
132 91 0161	Olsen-Hegar jehelec/nůžky tvrdokov; 17,0 cm	Olsen-Hegar needle holder TUC; 17,0 cm	130
132 91 0162	Olsen-Hegar jehelec/nůžky tvrdokov; 19,0 cm	Olsen-Hegar needle holder TUC; 19,0 cm	130
132 91 0167	Mathieu jehelec tvrdokov; 24,0 cm	Mathieu needle holder TUC; 24,0 cm	130
132 91 0168	Mathieu jehelec jemný tvrdokov; 17,0 cm	Mathieu needle holder TUC; 17,0 cm	130
132 91 0169	Mathieu jehelec jemný tvrdokov; 20,0 cm	Mathieu needle holder TUC; 20,0 cm	130
132 91 0170	Mathieu jehelec jemný tvrdokov; 23,0 cm	Mathieu needle holder TUC; 23,0 cm	130
132 91 0174	Metzenbaum jehelec zahnutý tvrdokov; 17,0 cm	Metzenbaum needle holder TUC; 17,0 cm	131
132 91 0175	Metzenbaum jehelec zahnutý tvrdokov; 19,5 cm	Metzenbaum needle holder TUC; 19,5 cm	131
132 91 0176	Mathieu-Ryder jehelec tvrdokov; 17,0 cm	Mathieu-Ryder needle holder TUC; 17,0 cm	131
132 91 0177	Mathieu-Ryder jehelec tvrdokov; 20,0 cm	Mathieu-Ryder needle holder TUC; 20,0 cm	131
132 91 0182	Boynton jehelec oční tvrdokov; 12,5 cm	Boynton needle holder TUC; 12,5 cm	132
132 91 0186	Hösel jehelec tvrdokov; 25,0 cm	Hösel needle holder TUC; 25,0 cm	132
132 91 0192	Luethy-Beck jehelec tvrdokov; 20,0 cm	Luethy-Beck needle holder TUC; 20,0 cm	132
132 91 0194	Langenbeck jehelec tvrdokov; 18,0 cm	Langenbeck needle holder TUC; 18,0 cm	132
132 91 0195	Langenbeck jehelec tvrdokov; 20,0 cm	Langenbeck needle holder TUC; 20,0 cm	132
132 91 0196	Langenbeck-Delicate jehelec tvrdokov; 18,0 cm	Langenbeck-Delicate needle holder TUC; 18,0 cm	132
132 91 0197	Langenbeck-Delicate jehelec tvrdokov; 20,0 cm	Langenbeck-Delicate needle holder TUC; 20,0 cm	132
132 91 0199	Langenbeck-Ryder jehelec tvrdokov; 18,0 cm	Langenbeck-Ryder needle holder TUC; 18,0 cm	132
132 91 0200	Langenbeck-Ryder jehelec tvrdokov; 20,0 cm	Langenbeck-Ryder needle holder TUC; 20,0 cm	132
132 91 0311	Deschamps jehla podvazovací ostrá; 20,0 cm	Deschamps ligature needle; 20,0 cm	127
132 91 0312	Deschamps jehla podvazovací ostrá; 20,0 cm	Deschamps ligature needle; 20,0 cm	127
132 91 0319	Deschamps jehla podvazovací tupá; 20,0 cm	Deschamps ligature needle; 20,0 cm	127
132 91 0320	Deschamps jehla podvazovací tupá; 20,0 cm	Deschamps ligature needle; 20,0 cm	127
133	PÁTRADLA	PROBES	
133 27 0011	Sims pátradlo děložní 1,75 mm; 36,5 cm	Sims uterine probe 1,75 mm; 36,5 cm	135
133 27 0130	Pátradlo děložní jemné 2,4 mm; 28,0 cm	Uterine probe 2,4 mm; 28,0 cm	135
133 91 0150	Saunders nástroj pro přenos IUD	Saunders instrument for removal I.U.D.	135
133 91 0151	Sims sonda děložní neohebná; 32,0 cm	Sims uterine sound rigid; 32,0 cm	134
133 91 0152	Sims sonda děložní ohebná; 32,0 cm	Sims uterine sound malleable; 32,0 cm	134
133 91 0153	Sims-Special sonda děložní; 32,0 cm	Sims-Special uterine sound; 32,0 cm	134
133 91 0154	Sims Swed. model sonda děložní; 26,0 cm	Sims Swed. model uterine sound; 26,0 cm	134
133 91 0155	Martin sonda děložní; 30,0 cm	Martin uterine sound; 30,0 cm	134
133 91 0156	Valleix sonda děložní; 25,0 cm	Valleix uterine sound; 25,0 cm	134
135	DILATÁTORY	DILATORS	
135 27 0010	Hegar dilatátor hrdla děložního ostrý; 20,0 mm	Hegar uterine dilator sharp; 20,0 mm	136
135 27 0011	Hegar dilatátor hrdla děložního tupý; 20,0 mm	Hegar uterine dilator blunt; 20,0 mm	136
135 27 0020	Hegar dilatátor hrdla děložního ostrý; 25,0 mm	Hegar uterine dilator sharp; 25,0 mm	136

číslo – number	název	item	strana – page
135 27 0021	Hegar dilatátor hrsla děložního tupý; 25,0 mm	Hegar uterine dilator blunt; 25,0 mm	136
135 27 0030	Hegar dilatátor hrsla děložního ostrý; 30,0 mm	Hegar uterine dilator sharp; 30,0 mm	136
135 27 0031	Hegar dilatátor hrsla děložního tupý; 30,0 mm	Hegar uterine dilator blunt; 30,0 mm	136
135 27 0040	Hegar dilatátor hrsla děložního ostrý; 35,0 mm	Hegar uterine dilator sharp; 35,0 mm	136
135 27 0041	Hegar dilatátor hrsla děložního tupý; 35,0 mm	Hegar uterine dilator blunt; 35,0 mm	136
135 27 0050	Hegar dilatátor hrsla děložního ostrý; 40,0 mm	Hegar uterine dilator sharp; 40,0 mm	136
135 27 0051	Hegar dilatátor hrsla děložního tupý; 40,0 mm	Hegar uterine dilator blunt; 40,0 mm	136
135 27 0060	Hegar dilatátor hrsla děložního ostrý; 45,0 mm	Hegar uterine dilator sharp; 45,0 mm	136
135 27 0061	Hegar dilatátor hrsla děložního tupý; 45,0 mm	Hegar uterine dilator blunt; 45,0 mm	136
135 27 0070	Hegar dilatátor hrsla děložního ostrý; 50,0 mm	Hegar uterine dilator sharp; 50,0 mm	136
135 27 0071	Hegar dilatátor hrsla děložního tupý; 50,0 mm	Hegar uterine dilator blunt; 50,0 mm	136
135 27 0080	Hegar dilatátor hrsla děložního ostrý; 55,0 mm	Hegar uterine dilator sharp; 55,0 mm	136
135 27 0081	Hegar dilatátor hrsla děložního tupý; 55,0 mm	Hegar uterine dilator blunt; 55,0 mm	136
135 27 0090	Hegar dilatátor hrsla děložního ostrý; 60,0 mm	Hegar uterine dilator sharp; 60,0 mm	136
135 27 0091	Hegar dilatátor hrsla děložního tupý; 60,0 mm	Hegar uterine dilator blunt; 60,0 mm	136
135 27 0100	Hegar dilatátor hrsla děložního ostrý; 65,0 mm	Hegar uterine dilator sharp; 65,0 mm	136
135 27 0101	Hegar dilatátor hrsla děložního tupý; 65,0 mm	Hegar uterine dilator blunt; 65,0 mm	136
135 27 0110	Hegar dilatátor hrsla děložního ostrý; 70,0 mm	Hegar uterine dilator sharp; 70,0 mm	136
135 27 0111	Hegar dilatátor hrsla děložního tupý; 70,0 mm	Hegar uterine dilator blunt; 70,0 mm	136
135 27 0120	Hegar dilatátor hrsla děložního ostrý; 75,0 mm	Hegar uterine dilator sharp; 75,0 mm	136
135 27 0121	Hegar dilatátor hrsla děložního tupý; 75,0 mm	Hegar uterine dilator blunt; 75,0 mm	136
135 27 0130	Hegar dilatátor hrsla děložního ostrý; 80,0 mm	Hegar uterine dilator sharp; 80,0 mm	136
135 27 0131	Hegar dilatátor hrsla děložního tupý; 80,0 mm	Hegar uterine dilator blunt; 80,0 mm	136
135 27 0140	Hegar dilatátor hrsla děložního ostrý; 85,0 mm	Hegar uterine dilator sharp; 85,0 mm	136
135 27 0141	Hegar dilatátor hrsla děložního tupý; 85,0 mm	Hegar uterine dilator blunt; 85,0 mm	136
135 27 0400	Hegar dilatátor hrsla děložního ostrý; 1,0 mm	Hegar uterine dilator sharp; 1,0 mm	136
135 27 0401	Hegar dilatátor hrsla děložního tupý; 1,0 mm	Hegar uterine dilator blunt; 1,0 mm	136
135 27 0410	Hegar dilatátor hrsla děložního ostrý; 1,5 mm	Hegar uterine dilator sharp; 1,5 mm	136
135 27 0411	Hegar dilatátor hrsla děložního tupý; 1,5 mm	Hegar uterine dilator blunt; 1,5 mm	136
135 91 0017	Hegar dilatátor hrsla děložního tupý; 9,0 mm	Hegar uterine dilator blunt; 9,0 mm	136
135 91 0018	Hegar dilatátor hrsla děložního tupý; 9,5 mm	Hegar uterine dilator blunt; 9,5 mm	136
135 91 0019	Hegar dilatátor hrsla děložního tupý; 10,0 mm	Hegar uterine dilator blunt; 10,0 mm	136
135 91 0020	Hegar dilatátor hrsla děložního tupý; 10,5 mm	Hegar uterine dilator blunt; 10,5 mm	136
135 91 0021	Hegar dilatátor hrsla děložního tupý; 11,0 mm	Hegar uterine dilator blunt; 11,0 mm	136
135 91 0022	Hegar dilatátor hrsla děložního tupý; 11,5 mm	Hegar uterine dilator blunt; 11,5 mm	136
135 91 0023	Hegar dilatátor hrsla děložního tupý; 12,0 mm	Hegar uterine dilator blunt; 12,0 mm	136
135 91 0024	Hegar dilatátor hrsla děložního tupý; 12,5 mm	Hegar uterine dilator blunt; 12,5 mm	136
135 91 0025	Hegar dilatátor hrsla děložního tupý; 13,0 mm	Hegar uterine dilator blunt; 13,0 mm	136
135 91 0026	Hegar dilatátor hrsla děložního tupý; 13,5 mm	Hegar uterine dilator blunt; 13,5 mm	136
135 91 0027	Hegar dilatátor hrsla děložního tupý; 14,0 mm	Hegar uterine dilator blunt; 14,0 mm	136
135 91 0028	Hegar dilatátor hrsla děložního tupý; 14,5 mm	Hegar uterine dilator blunt; 14,5 mm	136
135 91 0029	Hegar dilatátor hrsla děložního tupý; 15,0 mm	Hegar uterine dilator blunt; 15,0 mm	136
135 91 0030	Hegar dilatátor hrsla děložního tupý; 15,5 mm	Hegar uterine dilator blunt; 15,5 mm	136
135 91 0031	Hegar dilatátor hrsla děložního tupý; 16,0 mm	Hegar uterine dilator blunt; 16,0 mm	136
135 91 0032	Hegar dilatátor hrsla děložního tupý; 16,5 mm	Hegar uterine dilator blunt; 16,5 mm	136
135 91 0033	Hegar dilatátor hrsla děložního tupý; 17,0 mm	Hegar uterine dilator blunt; 17,0 mm	136
135 91 0034	Hegar dilatátor hrsla děložního tupý; 17,5 mm	Hegar uterine dilator blunt; 17,5 mm	136
135 91 0035	Hegar dilatátor hrsla děložního tupý; 18,0 mm	Hegar uterine dilator blunt; 18,0 mm	136
135 91 0036	Hegar dilatátor hrsla děložního tupý; 18,5 mm	Hegar uterine dilator blunt; 18,5 mm	136
135 91 0037	Hegar dilatátor hrsla děložního tupý; 19,0 mm	Hegar uterine dilator blunt; 19,0 mm	136
135 91 0038	Hegar dilatátor hrsla děložního tupý; 19,5 mm	Hegar uterine dilator blunt; 19,5 mm	136
135 91 0039	Hegar dilatátor hrsla děložního tupý; 20,0 mm	Hegar uterine dilator blunt; 20,0 mm	136
135 91 0040	Hegar dilatátor hrsla děložního tupý; 21,0 mm	Hegar uterine dilator blunt; 21,0 mm	136
135 91 0041	Hegar dilatátor hrsla děložního tupý; 22,0 mm	Hegar uterine dilator blunt; 22,0 mm	136
135 91 0042	Hegar dilatátor hrsla děložního tupý; 23,0 mm	Hegar uterine dilator blunt; 23,0 mm	136
135 91 0043	Hegar dilatátor hrsla děložního tupý; 24,0 mm	Hegar uterine dilator blunt; 24,0 mm	136
135 91 0044	Hegar dilatátor hrsla děložního tupý; 25,0 mm	Hegar uterine dilator blunt; 25,0 mm	136
135 91 0045	Hegar dilatátor hrsla děložního tupý; 26,0 mm	Hegar uterine dilator blunt; 26,0 mm	136
135 91 0046	Hegar dilatátor hrsla děložního tupý; 27,0 mm	Hegar uterine dilator blunt; 27,0 mm	136
135 91 0047	Hegar dilatátor hrsla děložního tupý; 28,0 mm	Hegar uterine dilator blunt; 28,0 mm	136
135 91 0048	Hegar dilatátor hrsla děložního tupý; 29,0 mm	Hegar uterine dilator blunt; 29,0 mm	136
135 91 0049	Hegar dilatátor hrsla děložního tupý; 30,0 mm	Hegar uterine dilator blunt; 30,0 mm	136
136	NÁSTROJE SPECIÁLNÍ	SPECIAL INSTRUMENTS	
136 08 0510	Elektroda rovná jehlová; 0,25 mm; 55 mm	Electrode; 0,25 mm; 55 mm	137
136 08 0520	Elektroda rovná jehlová; 0,4 mm; 55 mm	Electrode; 0,4 mm; 55 mm	137
136 08 0530	Elektroda rovná jehlová; 0,6 mm; 55 mm	Electrode; 0,6 mm; 55 mm	137
136 08 0540	Elektroda ohnutá s jehlou; 0,6 mm; 50 mm	Electrode; 0,6 mm; 50 mm	137
136 08 0550	Elektroda ohnutá rovnoběžná; 2,4 mm; 47 mm	Electrode; 2,4 mm; 47 mm	137
136 08 0560	Elektroda kruhová; 2,4 mm; 47 mm	Electrode; 2,4 mm; 47 mm	137
136 08 0570	Elektroda smyčková lichoběžníková; 2,4 mm; 47 mm	Electrode; 2,4 mm; 47 mm	137

číslo – number	název	item	strana – page
136 08 0580	Elektroda kuličková rovná; 2,4 mm; 42 mm	Electrode; 2,4 mm; 42 mm	137
136 08 0590	Elektroda kuličková rovná; 2,4 mm; 44 mm	Electrode; 2,4 mm; 44 mm	137
136 27 0310	Extraktor kovový; 26,5 cm	Extractor; 26,5 cm	142
136 27 0311	Extraktor kovový; 26,5 cm	Extractor; 26,5 cm	142
136 91 0004	Dlaha ochranná plastová	Plastic protection plate	138
136 91 0005	Materiál pro plastové dlahy	Plastic tubal-splint material	138
136 91 0006	Tyčinka retrakční atraumatická; 1,5 mm; 16,0 cm	Atraumatic retracting rod; 1,5 mm; 16,0 cm	139
136 91 0007	Tyčinka retrakční atraumatická; 1,5 mm; 20,0 cm	Atraumatic retracting rod; 1,5 mm; 20,0 cm	139
136 91 0008	Tyčinka retrakční atraumatická; 1,0 mm; 16,0 cm	Atraumatic retracting rod; 1,0 mm; 16,0 cm	139
136 91 0009	Tyčinka retrakční atraumatická; 1,0 mm; 20,0 cm	Atraumatic retracting rod; 1,0 mm; 20,0 cm	139
136 91 0010	Tyčinka retrakční atraumatická; 2,5 mm; 16,0 cm	Atraumatic retracting rod; 2,5 mm; 16,0 cm	139
136 91 0011	Tyčinka retrakční atraumatická; 2,5 mm; 20,0 cm	Atraumatic retracting rod; 2,5 mm; 20,0 cm	139
136 91 0012	Tyčinka retrakční atraumatická; 2,0 mm; 16,0 cm	Atraumatic retracting rod; 2,0 mm; 16,0 cm	139
136 91 0013	Tyčinka retrakční atraumatická; 2,0 mm; 20,0 cm	Atraumatic retracting rod; 2,0 mm; 20,0 cm	139
136 91 0014	Tyčinka retrakční atraumatická; 3,0 mm; 16,0 cm	Atraumatic retracting rod; 3,0 mm; 16,0 cm	139
136 91 0015	Tyčinka retrakční atraumatická; 3,5 mm; 16,0 cm	Atraumatic retracting rod; 3,5 mm; 16,0 cm	139
136 91 0016	Tyčinka retrakční atraumatická; 3,5 mm; 20,0 cm	Atraumatic retracting rod; 3,5 mm; 20,0 cm	139
136 91 0017	Tyčinka retrakční atraumatická; 3,0 mm; 20,0 cm	Atraumatic retracting rod; 3,0 mm; 20,0 cm	139
136 91 0018	Tyčinka retrakční atraumatická; 4,0 mm; 16,0 cm	Atraumatic retracting rod; 4,0 mm; 16,0 cm	139
136 91 0019	Tyčinka retrakční atraumatická; 4,0 mm; 20,0 cm	Atraumatic retracting rod; 4,0 mm; 20,0 cm	139
136 91 0020	Tyčinka retrakční atraumatická; 4,5 mm; 16,0 cm	Atraumatic retracting rod; 4,5 mm; 16,0 cm	139
136 91 0021	Tyčinka retrakční atraumatická; 4,5 mm; 20,0 cm	Atraumatic retracting rod; 4,5 mm; 20,0 cm	139
136 91 0022	Tyčinka retrakční atraumatická; 5,0 mm; 16,0 cm	Atraumatic retracting rod; 5,0 mm; 16,0 cm	139
136 91 0023	Tyčinka retrakční atraumatická; 5,0 mm; 20,0 cm	Atraumatic retracting rod; 5,0 mm; 20,0 cm	139
136 91 0024	Sonda skleněná sada; 3 ks	Glass sound set; 3 ks	139
136 91 0025	Ramathibodi manipulátor děložní; 27,5 cm	Ramathibodi uterine manipulator; 27,5 cm	141
136 91 0026	Ramathibodi hák; 25,0 cm	Ramathibodi tubual hook; 25,0 cm	141
136 91 0027	Iowa trubička; 14,0 cm	Iowa tube; 14,0 cm	138
136 91 0028	Krabice sterilizační 200×140×50 mm	Sterilization box 200×140×50 mm	140
136 91 0029	Krabice sterilizační 280×195×50 mm	Sterilization box 280×195×50 mm	140
136 91 0030	Krabice sterilizační 265×255×50 mm	Sterilization box 265×255×50 mm	140
136 91 0031	Krabice sterilizační 380×260×50 mm	Sterilization box 380×260×50 mm	140
136 91 0032	Krabice sterilizační 200×140×65 mm	Sterilization box 200×140×65 mm	140
136 91 0033	Krabice sterilizační 280×195×65 mm	Sterilization box 280×195×65 mm	140
136 91 0034	Krabice sterilizační 265×255×65 mm	Sterilization box 265×255×65 mm	140
136 91 0035	Krabice sterilizační 380×260×65 mm	Sterilization box 380×260×65 mm	140

A

Adson svorka na cévy	41
Alexander kleště na biopsii	67
Allis svorka chirurgická	25
Auvard zrcadlo poševní	105
Ayer škrabka děložní	114

B

Babcock svorka chirurgická	25
Baby-Adson svorka na cévy	41
Baby-Mikulicz svorka na pobřížnici	59
Baby-Mixer svorka preparační	47
Baby-Tischler kleště na biopsii	63
Backhaus svorka na papír	60
Backhaus svorka na prádlo	61
Backhaus svorka s kuličkou	60
Backhaus-Clip svorka na prádlo	61
Bainbridge svorka na cévy	42
Balfour rověrač břšní	94
Balfour-Baby rověrač břšní	97
Barrett kleště gynekologické	71
Beacham amniotom	91
Berger kleště na biopsii	68
Bernhard svorka na prádlo	60
Blake kyreta děložní	118
Boynnton jehelec oční tvrdokov	132
Bozemann jehelec hloubkový tvrdokov	128
Bozemann kleště tamponové	82
Braun cranioclast	84
Braun hák dekapilační	91
Braun-Stadler nůžky pro episiotomii	15
Breisky zrcadlo poševní	105
Bridge svorka preparační	46
Bumm kyreta děložní	119
Burke kleště na biopsii	62

C

Collin kyreta děložní	118
Collin rověrač břšní	93, 98
Collin zrcadlo poševní	107
Collin-Baby rověrač břšní	97
Crafoord svorka na cévy	44
Crile jehelec	131
Crile svorka na cévy	33
Crile-Rankin svorka na cévy	33
Cusco zrcadlo poševní	106
Cusco zrcadlo se sací trubičkou	111
Cusco-Suisse zrcadlo poševní	106

D

Dartigues kleště děložní	76
De Lee kleště porodní	79
Deaver nůžky chirurgické	12
Deschamps jehla podvazovací	127
Desjardins svorka na žlučovod	52
Dieffenbach svorka na cévy	26
Dlaha ochranná plastová	138
Douay kleště na biopsii	69
Doyen svorka na prádlo	60
Doyen šroub na myomy	126
Doyen zrcadlo poševní	104

Držadlo pro zrcadlo Scherback	104
Dubois nůžky gynekologické	16

E

Elektrody	137
Emmet hák na fistuli	92
Engl. modell svorka na prádlo	60
Eppendorf kleště na biopsii	68
Eppendorf koncovka	70
Extraktor kovový	142

F

Faure kleště na biopsii	64
Faure svorka na pobřížnici	59
Fergusson nůžky chirurgické	12
Fergusson svorka	58
Finocchietto svorka na ledviny	51
Finocchietto jehelec tvrdokov	129
Fomon nůžky preparační	19
Franz rověrač břšní	95
Friedman rověrač	98
Fritsch hák břšní	89

G

Gellhorn kleště na biopsii	64
Gemini svorka preparační	48
Gosset rověrač břšní	93, 94
Gourdet lžice děložní	116
Grave special zrcadlo	110
Grave zrcadlo	107, 109
Gray svorka na žlučovod	52
Green-Armytage kleště	79
Gross-Maier kleště tamponové	81
Guyon svorka na ledviny	50

H

Halsted-Mosquito svorka	30
Harrington hák břšní	90
Hartmann svorka	28
Heaney svorka na hysterektomii	54
Heaney-Ballantine svorka	55
Hegar dilatátor hrdla děložního	136
Heiss svorka na cévy	44
Herrick svorka na ledviny	50
Hösel jehelec tvrdokov	132

CH

Chaput svorka na cévy	27
-----------------------	----

I

Iowa kleště děložní	77
Iowa trubička	138
Israel hák na rány	86

J

Jacobs kleště gynekologické	75
Jehelec hloubkový	128, 129

Jehelec jemný	128
Jehelec s vnitřním uzávěrem	131
Johns-Hopkins svorka na cévy	26
Jones svorka na prádlo	60

K

Kantrowitz svorka preparační	48
Katetr k salpingografu	9
Kelly hák břišní	89
Kelly nůžky na fistuli	12
Kelly svorka na cévy	33
Kelly-Rankin svorka na cévy	33
Kevorkian kleště na biopsii	67
Kevorkian koncovka	70
Kevorkian kyreta sací pro biopsii	125
Kevorkian-Pacific kleště na biopsii	62
Kielland kleště porodní	80
Kielland-Luikart kleště porodní	80
Kilner nůžky preparační	20
Kirschner rozvěrač břišní	96
Kleště gynekologické	73
Kogan endozrcadlo	112
Kocher hák břišní	90
Kocher hák na rány	88
Kocher svorka na cévy	31, 32
Krabice sterilizační	140
Kristeller zrcadlo poševní	101, 102
Kužel	9
Kyreta aspirační	124
Kyreta děložní	120, 121

L

Lahey svorka na žlučovod	51
Landau zrcadlo poševní	105
Lane svorka na prádlo	60
Langenbeck hák na rány	87
Langenbeck jehelec tvrdokov	132
Langenbeck-Delicate jehelec tvrdokov	132
Langenbeck-Ryder jehelec tvrdokov	132
Lawrence svorka preparační	46
Leriche svorka na cévy	31
Lexer nůžky preparační	20
Lexer-Baby nůžky preparační	19
Lopatka pro O'Sullivan-O'Connor	113
Lopatka břišní	99
Lopatka k rozvěrači břišnímu Franz	95
Lopatka k rozvěrači břišnímu Kirschner	96
Lopatka k rozvěrači Collin-Baby	97
Lorna svorka na prádlo	61
Lower svorka na ledviny	51
Luethy-Beck jehelec tvrdokov	132
Lžice pro zrcadlo Scherback	104
Lžička děložní oválná	115

M

Manometr k salpingografu	9
Martel svorka na chlopeň	27
Martin pelvimetr	10
Martin sonda děložní	134
Masson jehelec tvrdokov	129
Materiál pro plastové dlahy	138
Mathieu jehelec tvrdokov	130
Mathieu-Ryder jehelec tvrdokov	131
Mayo nůžky preparační	18
Mayo-Stille nůžky preparační	18
McLean kleště porodní	80
Meecker svorka na cévy	41
Měřitko odstupňované	10
Metzenbaum jehelec tvrdokov	131

Metzenbaum nůžky preparační zahnuté	17
Metzenbaum-Delicate nůžky preparační	17
Metzenbaum-Nelson nůžky preparační	17
Micro-Bulldog svorka na cévy	25
Micro-Mosquito svorka	30
Micro-Mosquito svorka na cévy	30
Mikulicz hák břišní	90
Mikulicz svorka na pobřišnici	59
Milan kyreta na biopsii	124
Mini-Townsend koncovka	70
Mixer svorka preparační	47
Mixer-O'Shaugnessy svorka preparační	47
Mosquito-Halsted svorka	29
Museum kleště gynekologické	74

N

Naegele kleště porodní	79
Naegele perforátor	83
Nástroj pro přenos iud	83
Nástroje speciální	139
Negus svorka na žlučovod	52
New port páka laterální poševní	113
Nott zrcadlo poševní	107
Novak kyreta sací pro biopsii	125
Nůžky chirurgické	12, 13
Nůžky oční	22
Nůžky preparační	18 – 21

O

O'Sullivan-O'Connor rozvěrač břišní	96
Ochsner-Kocher svorka na cévy	36
Olsen-Hegar jehelec/nůžky tvrdokov	130
Overholt svorka na cévy s-prohnutá	40
Overholt svorka na lobektomii	37
Overholt-Geissendoerfer svorka na cévy	37

P

Páka poševní postranní	100, 101
Parametrium svorka	57
Pátradlo děložní	135
Pean svorka na cévy	28, 31
Pederson zrcadlo poševní	107
Pederson zrcadlo se sací trubičkou	111
Peers svorka na prádlo	61
Phaneuf svorka	55
Pinzeta anatomická	23
Pinzeta bipolární	24
Piper kleště porodní	79
Pozzi kleště gynekologické	71
Pratt kleště gynekologické	72
Pratt svorka na hemeroidy	58
Providence-hospital svorka na cévy	31
Providence-hospital svorka na cévy	31

R

Rám pro O'Sullivan-O'Connor	113
Ramathibodi hák	141
Ramathibodi manipulátor děložní	141
Randal kyreta sací pro biopsii	125
Recamier lžička děložní	115
Recamier/Sims kyreta	122
Redonova jehla	133
Reynolds nůžky preparační	21
Ricard rozvěrač břišní	98
Roberts svorka na cévy	44
Roeder svorka na prádlo	61
Rochester-Carmalt svorka na cévy	42

Rochester-Ochsner svorka na cévy	32
Rochester-Pean svorka na cévy	34, 35
Rozvěrač břišní řetízkový	97
Rumel svorka preparační	45

S

Saenger kleště děložní	77
Saigres kleště gynekologické	73
Sanvenero nůžky preparační	21
Sarot jehelec tvrdokov	129
Sarot svorka na cévy	44
Sarot uvolňovač	44
Saunders nástroj pro přenos UID	135
Segond nůž na myomy	11
Semb uvolňovač	49
Semm zrcadlo poševní	108
Seyffert zrcadlo poševní	108
Schaedel svorka na prádlo	60
Scherback zrcadlo poševní komplet	104
Schmidt-Sawtell svorka	42
Schröder kleště gynekologické	71, 72
Schubert kleště na biopsii	64, 65
Schultze salpinograp komplet	9
Schumacher kleště na biopsii	67
Schumacher-Van Doren kleště na biopsii	66
Siebolt nůžky děložní	16
Simon hák na fistuly	92
Simon/Schröder lžice děložní	116
Simpson kleště porodní	80
Simpson-Braun kleště porodní	80
Sims nůžky gynekologické	14
Sims pátradlo děložní	135
Sims sonda děložní	134
Sims Swed. model sonda děložní	134
Sims zrcadlo poševní	103
Sims/Recamier kyreta	123
Sims-Special sonda děložní	134
Skalpel s hranatým držadlem	11
Smellie hák dekapitační porodnický	91
Smellie perforátor	83
Somer kleště děložní	76
Sonda skleněná set	139
Spojka pro aspirační kyretu	124
Stille svorka na ledviny	50
Stříkačka k salpingografu	9
Svorka atraumatická	38, 39
Svorka na střeva	56

T

Tamier basiotribe	84
Teale kleště gynekologické	75
Thoms-Gaylor kleště na biopsii	65
Thorek nůžky preparační	19
Tischler držadlo	70
Tischler kleště na biopsii	63, 65
Tischler koncovka	70
Tischler-Kevorkian kleště na biopsii	62
Tischler-Morgan kleště na biopsii	63
Toennis svorka preparační	48
Tohoku-Japan svorka na prádlo	61
Tuffier svorka na cévy	27
Tycinka retrakční atraumatická	139

V

Valleix sonda děložní	134
Van Doren kleště na biopsii	66
Volkman hák na rány	85

W

Waldmann nůžky pro episiotomii	15
Wallich lžice děložní	117
Wangensteen jehelec tvrdokov	129
Wertheim svorka	53, 54
Wertheim-Cullen svorka na hysterektomii	55
Willet-Martel svorka na chlopeň	27
Winter kleště potratové	78
Wittner kleště na biopsii	68
Wrigley kleště porodní	79

Z

Závaží pro zrcadlo Scherback	104
Zenker svorka preparační	45

A

Abdominal spatula	99
Adson artery forceps	41
Alexander biopsy forceps	67
Allis tissue forceps	25
Artery forceps atraumatic jaws	38, 39
Aspirating curette	124
Atraumatic retracting rod	139
Auvard vaginal specula	105
Ayer uterina raspatorium	114

B

Babcock tissue clamp	25
Baby-Adson artery forceps	41
Baby-Mikulcz peritoneal forceps	59
Baby-Mixter dissecting forceps	47
Baby-Tischler biopsy forceps	63
Backhaus paper forceps	61
Backhaus towel forceps	61
Backhaus towel forceps	61
Backhaus-Clip towel forceps	61
Bainbridge artery forceps	42
Balfour abdominal retractor	94
Balfour-Baby abdominal retractor	97
Barrett gynaecological forceps	71
Beacham amniotome	91
Berger biopsy forceps	68
Bernhard towel forceps	60
Bipolar forceps bay-shaped	24
Blade for abdominal retractor Collin-Baby	97
Blade for abdominal retractor Franz	95
Blade for abdominal retractor Kirschner	96
Blade for retractor O'Sullivan-O'Connor	113
Blade for specula Scherback	104
Blake uterine curette	118
Boynnton needle holder TUC	132
Bozemann needle holder TUC	128
Bozemann sponge holding forceps	82
Braun cranioclast	84
Braun decapilation hook	91
Braun-Stadler episiotomy scissors	15
Breisky vaginal specula	105
Bridge dissecting forceps	46
Bumm uterine curette	119
Burke cervical biopsy forceps	62

C

Chainal abdominal retractor	97
Chaput artery forceps	27
Collin abdominal retractor	93, 98
Collin uterine curette	118
Collin vaginal specula	107
Collin-Baby abdominal retractor	97
Cone	9
Connector for aspirating curette	124
Crafoord artery forceps	44
Crile needle holder dia	131
Crille artery forceps	33
Crille-Rankin artery forceps	33
Cusco vaginal specula	106
Cusco vaginal specula with suction tube	111
Cusco-Suisse vaginal specula	106

D

Dartigues uterine elevating forceps	76
De lee obstetrical forceps	79
Deaver operating scissors	12
Deschamps ligature needle	127
Desjardins gall duct forceps	52
Dieffenbach artery forceps	26
Dissecting scissors	18–21
Douay biopsy forceps	69
Doyen myoma instrument	126
Doyen towel forceps	60
Doyne vaginal specula	104
Dressing forceps	23
Dubois cephalotomy scissors	16

E

Elektrode	137
Emmet fistula hook	92
Eng. modell towel forceps	60
Eppendorf biopsy tip	70
Eppendorpf biopsy forceps	68
Extractor	142
Eye scissors	22

F

Faure biopsy forceps	64
Faure peritoneal forceps	59
Fergusson angiotribe clamp	58
Fergusson operating scissors	12
Finnocchetto kidney forceps	51
Finocchetto needle holder TUC	129
Fomon dissecting scissors	19
Frame for retractor O'Sullivan-O'Connor	113
Franz abdominal retractor	95
Friedman retractor	98
Fritsch abdominal retractor	89

G

Geelhorn biopsy forceps	64
Gemini dissecting forceps	48
Glass sound	139
Gosset abdominal retractor	93, 94
Gourdet uterine scoop	116
Grave special vaginal specula with suction tube	110
Grave vaginal specula	107, 109
Gray gall duct clamp	52
Green-Armytage forceps	79
Gross-Maier sponge holding forceps	81
Guyon Kidney pedicle clamp-forceps	50
Gynaecological forceps	73

H

Halsted-Mosquito artery forceps	30
Handle for vaginal specula scherback	104
Harrington abdominal retractor	90
Hartmann forceps	28
Heaney hysterectomy clamp-forceps	54
Heaney-Ballantine hysterectomy clamp-forceps	55
Hegar uterine dilator	136
Heiss artery forceps	44

Herrick kidney forceps	50	Metzenbaum-Delicate scissors	17
Hösel needle holder TUC	132	Metzenbaum-Nelson dissecting scissors	17
I		Micro-Bulldog artery forceps	25
Instrument for removal of I.U.D	83	Micro-Mosquito artery forceps	30
Intestinal forceps	56	Mikulicz abdominal retractor	90
Iowa tenaculum forceps	77	Milan biopsy curette	124
Iowa tube	138	Mini-Townsend biopsy tip	70
Israel retractor	86	Mixer dissecting forceps	47
		Mixer-O'Shaughnessy dissecting forceps	47
		Mosquito-Halsted artery forceps	29
		Mukulicz peritoneal forceps	59
		Museux gynaecological forceps	74
J		N	
Jacobs gynaecological forceps	75	Naegele perforator	79
Johns-Hopkins artery forceps	26	Naegele perforator	83
Jones towel forceps	60	Needle holder TUC	128
		Needle holder TUC	131
		Negus gall duct clamp	52
		New port vaginal retractor	113
		Nott vaginal specula	107
		Novak suction biopsy curette	125
K		O	
Kantrowitz dissecting forceps	48	O'Sullivan-O'Connor abdominal retractor	96
Kelly abdominal retractor	89	O'Sullivan-O'Connor retractor complete	113
Kelly artery forceps	33	Ochsner-Kocher artery forceps	36
Kelly fistula scissors	14	Olsen-Hegar needle holder TUC	130
Kelly-Rankin artery forceps	33	Operating knife for gynaecology	11
Kevorkian biopsy forceps	67	Overholt artery forceps	40
Kevorkian biopsy tip	70	Overholt lobectomy forceps	37
Kevorkian suction biopsy curette	125	Overholt-Geissendoerfer artery forceps	37
Kevorkian-Pacific biopsy forceps	62		
Kielland forceps	80	P	
Kielland-Luikart forceps	80	Parametrium forceps	57
Kilner dissecting scissors	20	Pean artery forceps	28, 31
Kirschner abdominal retractor	96	Pederson vaginal specula	107
Kogan endospecula	112	Pederson vaginal specula with suction tube	111
Kocher abdominal retractor	88	Peers towel forceps	61
Kocher abdominal retractor	90	Phaneuf hysterectomy forceps	55
Kocher artery forceps	31, 32	Piper forceps	79
Kristeller vaginal specula	101, 102	Plastic protection plate	138
		Plastic tubal-splint material	138
		Pozzi gynaecological forceps	71
		Pratt gynaecological forceps	72
		Pratt haemorrhoidal forceps	58
		Providence-Hospital artery forceps	31
L		R	
Lahey gall duct clamp	51	Ramathibodi tubal hook	141
Landau vaginal specula	105	Ramathibodi uterine manipulator	141
Lane towel forceps	60	Randal suction biopsy curette	125
Langenbeck needle holder TUC	132	Recamier uterine scoop	115
Langenbeck retractor	87	Recamier/Sims uterine curette	122
Langenbeck-Delicate needle holder TUC	132	Redon needle	133
Langenbeck-Ryder needle holder TUC	132	Reynolds dissecting scissors	21
Lawrence dissecting forceps	46	Ricard abdominal retractor	98
Leriche artery forceps	31	Roberts artery forceps	44
Lexer dissecting scissors	20	Roeder towel forceps	61
Lexer-Baby dissecting scissors	19	Rochester-Carmalt artery forceps	42
Lorna towel forceps	61	Rochester-Ochsner artery forceps	32
Lower kidney pedicle forceps	51	Rochester-Pean artery forceps	34, 35
Luethy-Beck needle holder TUC	132	Rumel dissecting forceps	45
		Ryder needle holder TUC	128, 129
M			
Manometer for salpingograph	9		
Martel flap forceps	27		
Martin pelvimeter	10		
Martin uterine sound	134		
Masson needle holder TUC	129		
Mathieu needle holder TUC	130		
Mathieu-Ryder needle holder TUC	131		
Mayo dissecting scissors	18		
Mayo-Stillie dissecting scissors	18		
Mclean obstetrical forceps	80		
Measuring instrument	10		
Meeker artery forceps	41		
Metzenbaum dissecting scissors	17		
Metzenbaum needle holder TUC	131		

S

Saenger ovum forceps	77
Saigres gynaecological forceps	73
Sanvenero dissecting scissors	21
Sarot artery forceps	44
Sarot dissecting forceps	44
Sarot needle holder TUC	129
Saunders instrument for removal I.U.D.	135
Segond myomy knife	11
Semb dissecting forceps	49
Semm vaginal specula	108
Seyffert vaginal specula	108
Shaedel towel forceps	60
Scherback vaginal specula complete	104
Schmidt-Sawtell artery forceps	42
Schröder gynaecological forceps	61, 72
Schubert biopsy forceps	64, 65
Schultze salpinograph	9
Schumacher biopsy forceps	67
Schumacher-Van Doren biopsy forceps	66
Siebolt uterine scissors	16
Simon fistula hook	92
Simon/Schröder uterine scoop	116
Simpson obstetrical forceps	80
Simpson-Braun obstetrical forceps	80
Sims gynaecological scissors	14
Sims special uterine sound	134
Sims Swed. model uterine sound	134
Sims uterine probe	135
Sims uterine sound rigid	134
Sims vaginal specula	103
Sims/Recamier uterine curette	123
Siringe for salpingograph	9
Smellie decapilation hook	91
Smellie perforator	83
Somer uterine elevating forceps	76
Standard operating scissors	12, 13
Sterilization box	140
Stille kidney forceps	50

T

Tarnier basiotribe	84
Teale gynaecological forceps	75
Thoms-Gaylor biopsy forceps	65
Thorek dissecting scissors	19
Tischler biopsy forceps	63, 65
Tischler handle	70
Tischler tip	70
Tischler-Kevorkian biopsy forceps	62
Tischler-Morgan biopsy forceps	63
Toennis dissecting forceps	48
Tohoku-Japan towel forceps	61
Tubal katheter	9
Tuffier artery forceps	27

U

Uterina scoop	115
Uterine curette	120, 121
Uterine probe	135

V





















Vaginal elevator	100, 101
Valleix uterine sound	134
Van Doren biopsy forceps	66
Volkman retractor	85

W

Waldmann episiotomy scissors	15
Wallich uterine scoop	117
Weight for vaginal specula	104
Wertheim hysterectomy forceps	53, 54
Wertheim-Cullen hysterectomy forceps	55
Willet-Martel flap forceps	27
Winter abortion forceps	78
Wittner biopsy forceps	68
Wangensteen needle holder TUC	129
Wrigley obstetrical forceps	79

Z

Zenker dissecting forceps	45
---------------------------	----

	použit do	use by
	datum výroby	date of manufacture
	výrobce	manufacturer
	nepoužívat znovu	do not reuse
	neprovádět opětovnou sterilizaci	do not resterilize
	nepoužívat, jestliže je balení poškozeno	do not use if package is damaged
	otevřené balení nebude nahrazeno	opened packages are not replaced
	set, souprava	assortment
	pozor sledujte průvodní dokumentaci	caution, consult accompanying documents
	nesterilní	non sterile
	kód dávky	batch code
	katalogové číslo	catalogue number
	množství	quantity
	kontrola	control
	sterilní	sterile
	sterilizace ozářením	sterilization using irradiation
	sterilizace ethylenoxidem	sterilization using ethylene oxide
	sterilní zdravotnické prostředky zpracované aseptickou technologií	sterile by aseptic techniques
	diagnostický zdravotnický prostředek in vitro	in vitro diagnostic medical device
	globální nomenklatura zdravotnických prostředků	global medical device nomenclature code
	sledujte návod k použití	consult instructions for use

- ▶ **CHIRURGIE / SURGERY**
- ▶ **TRAUMATOLOGIE / TRAUMATOLOGY**
- ▶ **ORTOPEDIE / ORTHOPAEDICS**
- ▶ **STOMATOLOGIE / DENTISTRY**
- ▶ **STERILIZACE / STERILIZATION**
- ▶ **LAPAROSKOPIE / LAPAROSCOPY**
- ▶ **ENDOSKOPIE / ENDOSCOPY**
- ▶ **SOFTWARE / SOFTWARE**



kompletní nabídka lékařských nástrojů a implantátů na
full range of medical instruments and implants on

▶ **www.medin.cz**

© 2009 MEDIN, a.s.; Všechna práva vyhrazena.

Dokument je určen pro obchodní účely MEDIN, a.s., údaje zde uvedené jsou informativního charakteru.

Žádná část tohoto dokumentu nesmí být reprodukována nebo publikována v jakékoliv formě bez předchozího souhlasu MEDIN, a.s.

Zobrazení produktů odpovídá aktuálnímu stavu v době vydání tohoto dokumentu. Změny technických parametrů z důvodu dalšího vývoje jsou vyhrazeny.

Tiskové a typografické chyby jsou vyhrazeny.

© 2009 MEDIN, a.s.; All rights reserved.

This document should be used for commercial purposes of MEDIN, a.s.; the data mentioned in the document has informative character.

No part of this document can be copied or published in any form without approval of MEDIN, a.s.

The product design may differ from those depicted in these illustrations at the date of issue. Adjustments, made from the reason of further developments of technical parameters, are reserved.

Printing and typographical errors are reserved.

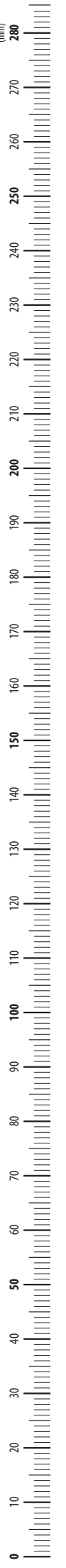

MEDIN, a.s.

Vlachovická 619
Nové Město na Moravě
CZ 592 31
Czech Republic
IČO 43378030
DIČ CZ43378030

CENTRÁLA

tel.: 566 684 111

PRODEJ ČESKÁ REPUBLIKA

tel.: 566 684 327-8
fax: 566 684 384
e-mail: prodej@medin.cz

PRODEJNA PRAHA

Jana Želivského 6
Praha 3
CZ 130 00
tel./fax: 222 592 334
mobil: 606 686 530

PRODEJ SLOVENSKÁ REPUBLIKA

tel.: +420 566 684 332
fax: +420 566 684 385
e-mail: export@medin.cz

EXPORT

phone: +420 566 684 336
fax: +420 566 684 385
e-mail: export@medin.cz

www.medin.cz

NÁSTROJE PRO GYNEKOLOGII INSTRUMENTS FOR GYNAECOLOGY

2009

