

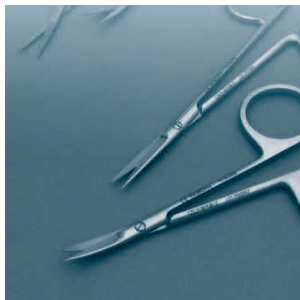

NÁSTROJE PRO OČNÍ LÉKAŘSTVÍ
INSTRUMENTS FOR OPHTHALMOLOGY

O Č N Í L É K A Ř S T V Í – O P H T A L M O L O G Y

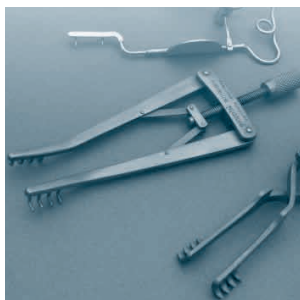

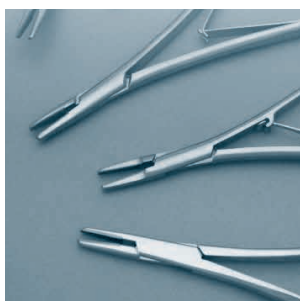
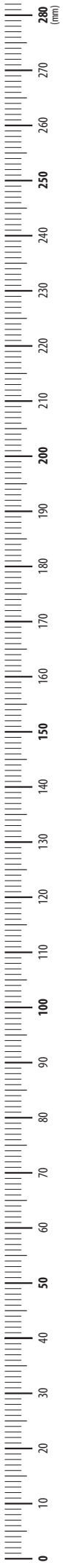

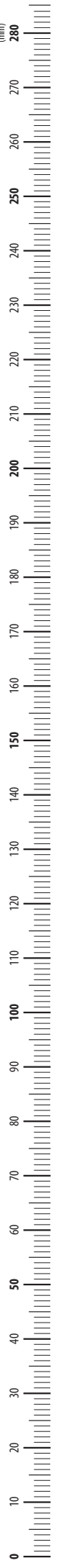

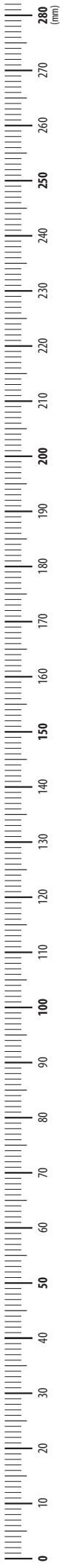

MEDIN, a.s.

Vlachovická 619
Nové Město na Moravě
CZ 592 31
Czech Republic
IČO 43378030
DIČ CZ43378030

CENTRÁLA

tel.: 566 684 111

PRODEJ ČESKÁ REPUBLIKA

tel.: 566 684 327-8
fax: 566 684 384
e-mail: prodej@medin.cz

PRODEJNA PRAHA

Jana Želivského 6
Praha 3
CZ 130 00
tel./fax: 222 592 334
mobil: 606 686 530

PRODEJ SLOVENSKÁ REPUBLIKA

tel.: +420 566 684 332
fax: +420 566 684 385
e-mail: export@medin.cz

EXPORT

phone: +420 566 684 336
fax: +420 566 684 385
e-mail: export@medin.cz

www.medin.cz





Certifikát EN ISO 13485
Certificate EN ISO 13485

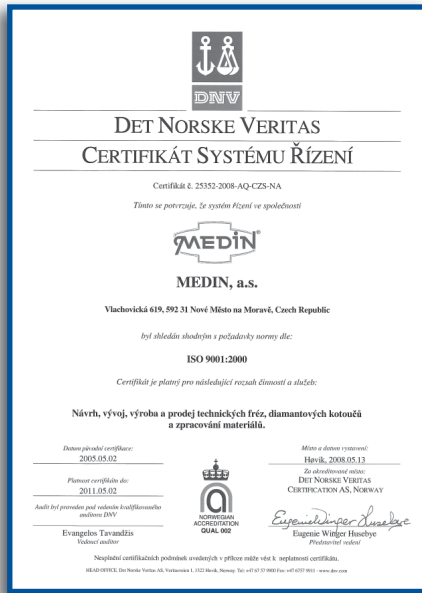

Certifikát ISO 9001
Certificate ISO 9001



Certifikát ISO 14001
Certificate ISO 14001

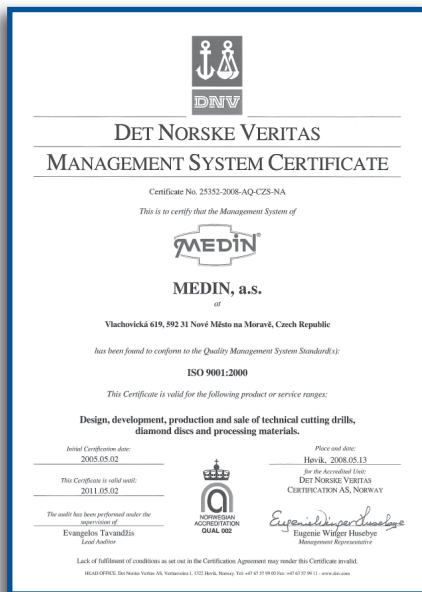

Akciová společnost MEDIN se sídlem v Nové Městě na Moravě zahájila činnost 4. 5. 1992 jako právní nástupce bývalého státního podniku Chirana Nové Město na Moravě.

MEDIN, a.s., je největší český výrobce nástrojů pro humánní lékařství ve všech hlavních oborech lékařských specializací včetně kostní chirurgie a implantátů pro traumatologii a ortopedii. Zároveň je největším českým výrobcem dentálních nástrojů jak ordinálních, tak rotačních.

Dlouholetá tradice výroby lékařských nástrojů, začínající již v roce 1949, vytvořila know-how umožňující dodávat výrobky vysoké kvality s ohledem na dosažení vysoké míry bezpečnosti odpovídající vysoké úrovni ochrany zdraví. Úroveň, kvalita a bezpečnost všech nástrojů je pečlivě posuzována. Akcent na kvalitu a bezpečnost nástrojů je tradičně zakotven ve firemní politice jakosti a strategii firmy. V kvalitě používá firma účinných postupů dle mezinárodních norem *ISO 9001 Systémy managementu kvality* a *ISO 13485 Systémy jakosti – Zdravotnické prostředky*, jejichž certifikáty jsou pravidelně obnovovány. Důležitou oblastí je splnění legislativních podmínek při uvádění výrobků na trh, zejména evropské direktivy Medical Device 93/42/EHS.

MEDIN, a.s., uplatňuje aktivní postoj k ochraně životního prostředí a praktickou činností směřuje k minimalizaci dopadů vlivů firemních činností na životní prostředí. Komplex výrobních, pomocných a administrativních prostor společnosti splňuje použitými technologiemi a energetickými zdroji přísná ekologická hlediska. Prostřednictvím profesně i odborně způsobilých pracovníků trvale udržuje šetrný vztah k životnímu prostředí. Environmentální management firmy je udržován v souladu s mezinárodní normou *ISO 14001 Systémy environmentálního managementu*.

MEDIN, the joint-stock company, having its headquarters in Nové Město na Moravě commenced its activity on May 4, 1992 as a legal successor of the former state-owned enterprise Chirana Nové Město na Moravě.

MEDIN, the joint-stock company, is the greatest Czech producer of instruments for human medicine in all main fields of medical specialisations, including the bone surgery and implants for traumatology and orthopaedics. It is also the biggest producer of surgery and rotary dental instruments.

A long standing tradition of surgical instruments production, founded as early as 1949, has established a know-how that enables to provide products of high quality and safety corresponding to high level of health protection. The standards, quality and safety of all instruments are carefully evaluated. The quality and safety of the instruments are traditionally anchored in the company's quality policy and company's strategy. We use the effective procedures according to the International Standard *ISO 9001 – Systems of quality management* and *ISO 13485 Quality Systems – Medical Instruments* whose certificates are regularly renewed. It is also very important to follow the legislative conditions when launching the products on the market, mainly the European Directive Medical Devices 93/42/EEC.

MEDIN, the joint-stock company, cares about the environment actively and minimises the impacts of the company's activity on the environment. The complex of production, auxiliary and administration buildings of the company meets the strict environmental aspects with the applied technologies and energy sources.

We permanently keep a considerate relation with our environment through our professionals and specialists. The Environmental management of the company is in conformity with *ISO 14001 – Systems of environmental management*.



397 111 Diagnostika	Diagnostics	9
397 112 Nástroje řezné	Cutting Instruments	10–11
397 113 Nůžky	Scissors	12–17
397 114 Pinzety	Forceps	18–25
397 115 Svorky	Clamps, Forceps	26
397 118 Háky	Hooks, Retractors	27–29
397 119 Rozvěrače	Retractors	30
397 121 Lopatky	Spatulas	31
397 124 Škrabky	Raspatories	32
397 125 Lžičky	Spoons	33–34
397 126 Kyrety	Curettes	35
397 132 Jehly, jehelce	Needles, Needle Holders	36–42
397 133 Pátradla	Probes	43–44
Číselný rejstřík	Numerical Index	45–48



1/1

MĚŘÍTKO
 RULE
111 38 0030
 10,5 cm



1/1

MĚŘÍTKO NA URČENÍ TRHLIN
 RULE FOR CRACKS DETERMINATION
111 38 0010
 13,0 cm



1/1

SKLERÁLNÍ DEPRESOR
 COMPRESSOR
111 38 0200
 průměr – diameter
 20 mm
 4,2 cm



DIEFFENBACH
12,5 cm



112 38 0010
Fig. 1
12,5 cm



112 38 0020
Fig. 2
13,0 cm



112 38 0030
Fig. 4
13,5 cm



112 38 0040
Fig. 5
14,0 cm



112 38 0110
Fig. 7
12,5 cm



112 38 0120
Fig. 8
13,0 cm



112 38 0130
Fig. 9
13,5 cm



112 38 0140
Fig. 10
14,0 cm



NÁSTROJ DVOJITÝ NA CIZÍ TĚLESO V ROHOVCE
DOUBLE FOREIGN BODY INSTRUMENT

112 38 2200
10,0 cm



NŮŽ NA KERATOPLASTIKU
KERATOPLASTY KNIFE

112 38 0930

13,3 cm

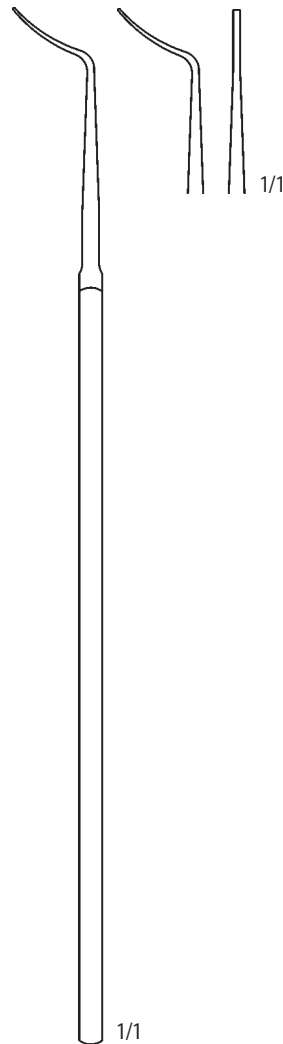

SYNECHIOTOM
SYNECHIOTOME

112 38 0980

13,7 cm



DRŽÁTKO ÚLOMKU ŽILETEK
BLADE FRAGMENT HOLDER

112 38 1440

9,0 cm

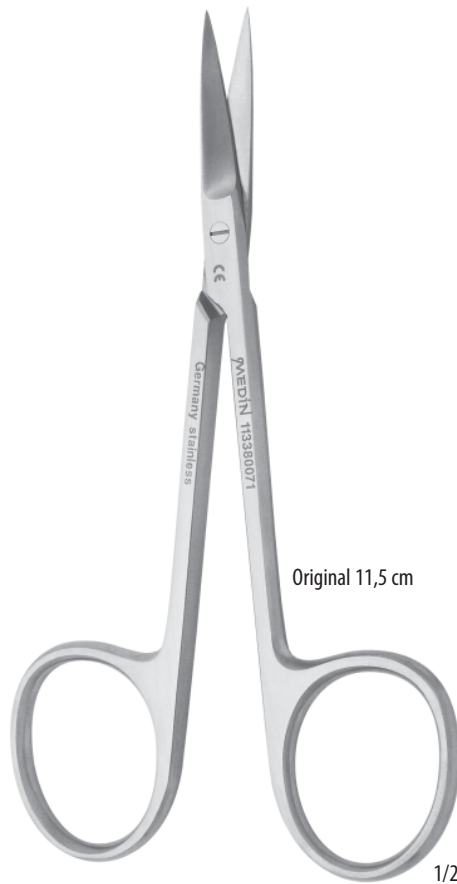

Original 11,5 cm

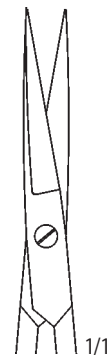

rovné – straight

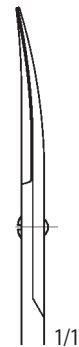
113 38 0010 – 10,0 cm –**113 38 0071** – 11,5 cm –

zahnuté – curved

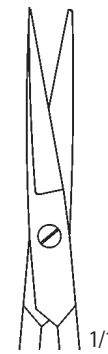
113 38 0040**113 38 0091**

rovné – straight

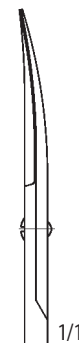
113 38 0020 – 10,0 cm –**113 38 0150** – 11,5 cm –

zahnuté – curved

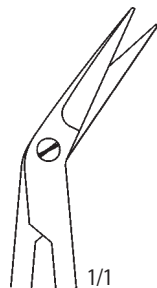
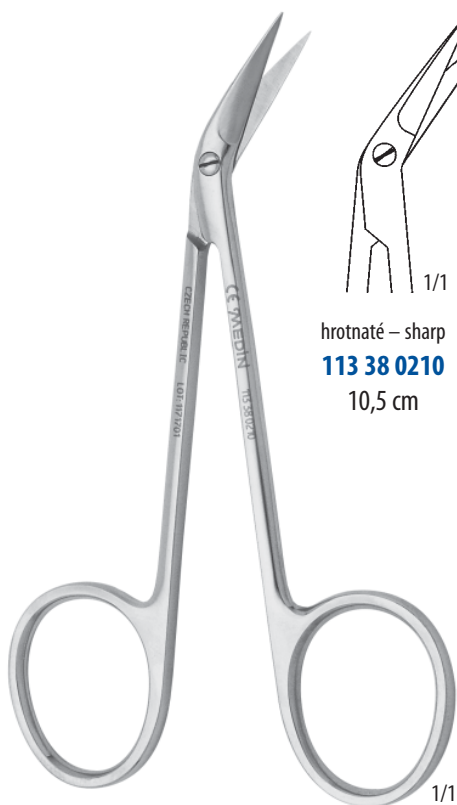
113 38 0050**113 38 0100**

hrotnaté – sharp

113 38 0210

10,5 cm

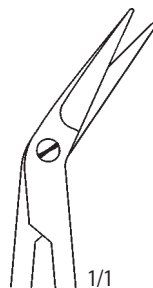

tupé – blunt

113 38 0260

10,5 cm

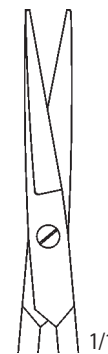

rovné – straight

113 38 0030 – 10,0 cm –**113 38 0081** – 11,5 cm –

zahnuté – curved

113 38 0060**113 38 0161**



NŮŽKY OČNÍ
EYE SCISSORS
113 38 0311
11,5 cm

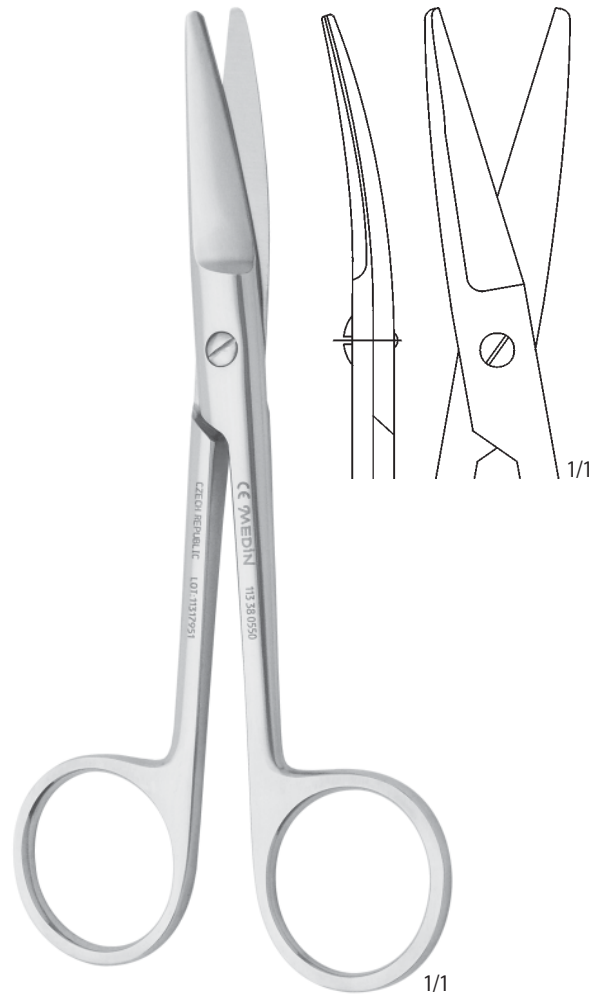

NŮŽKY ENUKLEAČNÍ
ENUCLEATION SCISSORS
113 38 0550
zahnuté – curved
13,0 cm



STEVENS



113 91 0379
10,5 cm

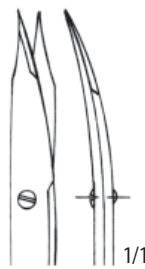

113 91 0381
10,5 cm



113 91 0383
10,5 cm

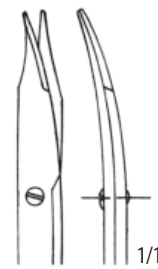

113 91 0385
10,5 cm

113 91 0380
11,5 cm

113 91 0382
11,5 cm

113 91 0384
11,5 cm

113 91 0386
11,5 cm

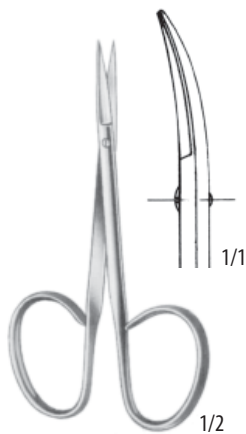

10,0 cm
sharp

113 91 0387 **113 91 0388**
rovné – straight zahnuté – curved



10,0 cm
blunt

113 91 0389 **113 91 0390**
rovné – straight zahnuté – curved

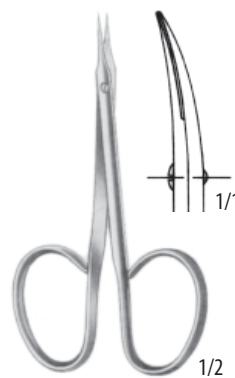

9,5 cm
sharp

113 91 0393 **113 91 0394**
rovné – straight zahnuté – curved

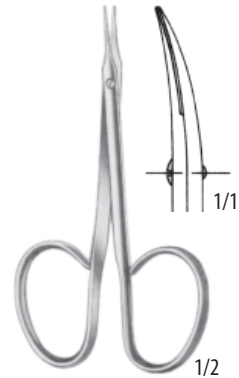

9,5 cm
blunt

113 91 0395 **113 91 0396**
rovné – straight zahnuté – curved

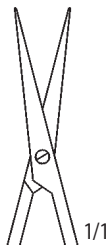

rovné – straight
113 38 0850



13,0 cm



zahnuté – curved
113 38 0860



NOYES
12,0 cm



113 91 0490



113 91 0492



113 91 0494



Original 10,0 mm

BARRAQUER

5,5 cm

113 91 0499 5,0 mm

113 91 0500 7,0 mm

113 91 0501 10,0 mm

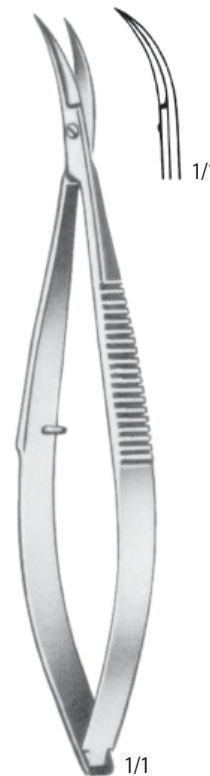

CASTROVIEJO

113 91 0507

10,0 cm



CASTROVIEJO

113 91 0508

10,0 cm



CASTROVIEJO
9,0 cm



1/1
113 91 0502



1/1
113 91 0503



1/1
113 91 0505



WESTCOTT
113 91 0518
11,0 cm



WESTCOTT
113 91 0517
11,0 cm



CASTROVIEJO
113 91 0521
11,0 cm



CASTROVIEJO
113 91 0522
11,0 cm



113 38 1020
9,1 cm



113 38 1030
9,2 cm



1/1

GRAEFE
10,5 cm



114 38 0010

114 38 0030
nemagnetická
non magnetic



114 38 0020
jemná – fine

114 38 0040
jemná, nemagnetická
fine, non magnetic

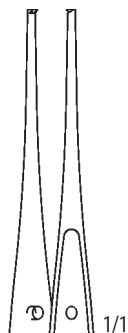

114 38 0150

114 38 0170
nemagnetická
non magnetic



114 38 0160
jemná – fine

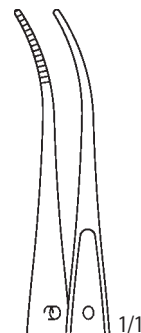

114 38 0100
jemná – fine

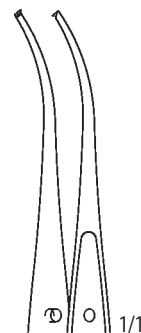

114 38 0200
jemná – fine



1/1

GRAEFE
10,0 cm

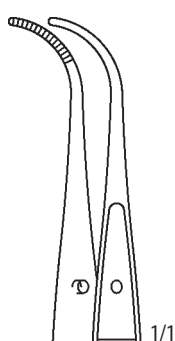

114 38 0110

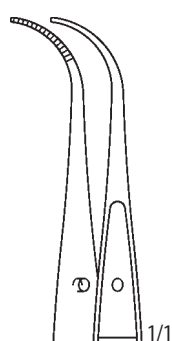

114 38 0120
nemagnetická
non magnetic

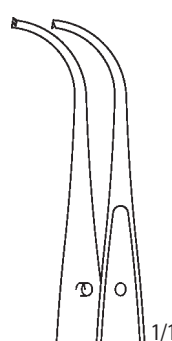

114 38 0210
nemagnetická
non magnetic



114 91 0366



114 91 368



114 91 0372



114 91 0374



1/1

GRAEFE
10,0 cm



GRAEFE
114 38 0350
 11,0 cm



GRAEFE
114 38 0360
 se zámkem – with lock
 11,0 cm



ELSCHMIG
114 38 0370
 10,5 cm



PINZETA ENUKLEAČNÍ
ENUCLEATION FORCEPS
114 38 0750
 14,0 cm

PINZETY NA DUHOVKU
IRIS FORCEPS

114 38 0250
 anatomická – tissue
 4,8 cm

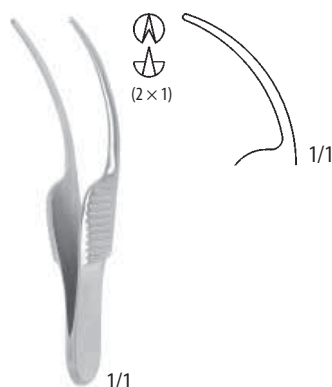

114 38 0270
 chirurgická – dressing
 4,8 cm

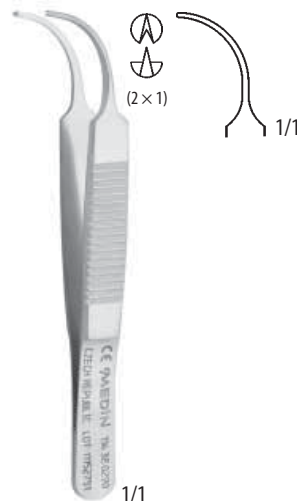

LANDOLT
114 38 0290
 6,5 cm



114 38 0300
 8,5 cm

PINZETY OČNÍ
EYE FORCEPS

KOUTNÝ
114 38 0230
 10,0 cm



KUHNT
114 38 0590
 10,2 cm



ELSCHNIG
114 38 0600
 10,7 cm



ELSCHNIG
114 38 0610
 10,7 cm



ARRUGA
114 38 0620
 10,8 cm



KALT
114 38 0630
 10,2 cm



BONEFONE
114 38 0640
 10,7 cm



VERHOFF
114 38 0650
 10,6 cm



1/1

114 38 0510

PINZETA NA ŠITÍ ROHOVKOVÉHO TERČE
FORCEPS FOR CORNEA SUTURING
11,0 cm



1/1

114 38 0450

4,0 mm



1/1

114 38 0460

4,5 mm



1/1

114 38 0470

5,0 mm



1/1

114 38 0480

5,5 mm



1/1

114 38 0490

6,0 mm



1/1

114 38 0500

7,0 mm



1/1

114 38 0510

8,0 mm



1/1

PINZETA NA OPERACI ŠILHÁNÍ
STRABISMUS FORCEPS
se zámkem – with lock
9,5 cm

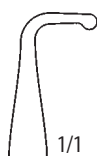

1/1

114 38 0810
pravá – right

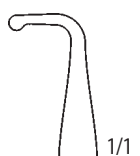

1/1

114 38 0820
levá – left



1/1

BLASCOVICS
se šroubem – with screw
9,5 cm

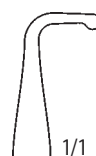

1/1

114 38 0830
pravá – right



1/1

114 38 0840
levá – left



1/1

PINZETA NA SILIKONOVÉ PLOMBY
SILICON SEAL FORCEPS
114 38 1140
13,0 cm



1/1

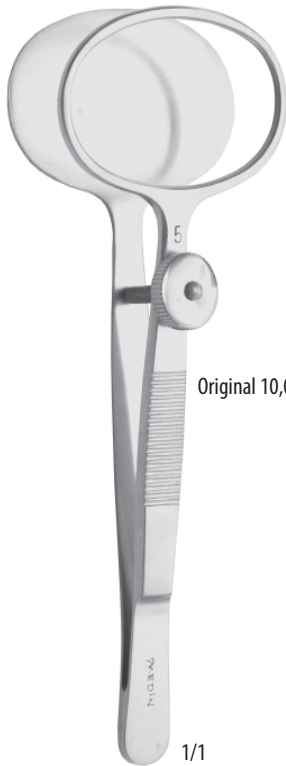

Original 10,0 cm

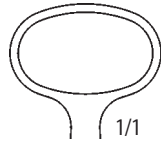
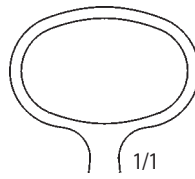
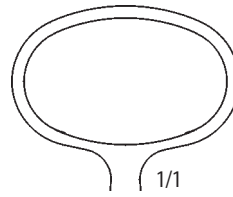
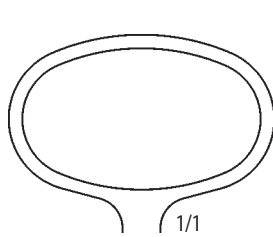
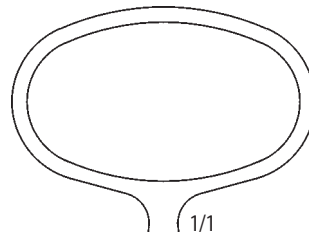
DESMARRES

114 38 0910
Fig. 1
8,8 cm

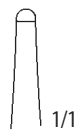
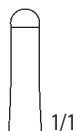
114 38 0920
Fig. 2
9,2 cm

114 38 0930
Fig. 3
9,5 cm

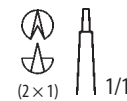
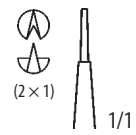
114 38 0940
Fig. 4
9,8 cm

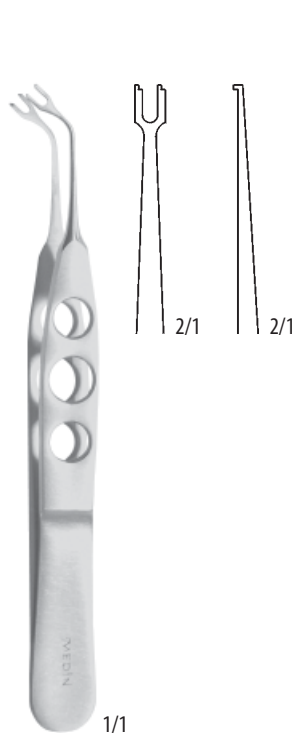
114 38 0950
Fig. 5
10,0 cm

LAMBERT
114 38 0960
9,0 cm

BEER
8,5 cm

114 38 1110

114 38 1120

 PINZETA NA ŘASY
CILIA FORCEPS
114 38 1170
8,7 cm

 PINZETA STEHOVÁ
SUTURING FORCEPS
114 38 1340
7,8 cm

114 38 1340
7,8 cm

114 38 1350
8,2 cm



PINZETA NA KERATOPLASTIKU
KERATOPLASTIC FORCEPS
114 38 1230
8,5 cm



KALT
114 38 1260
9,5 cm



CASTROVIEJO
114 38 0850
10,0 cm

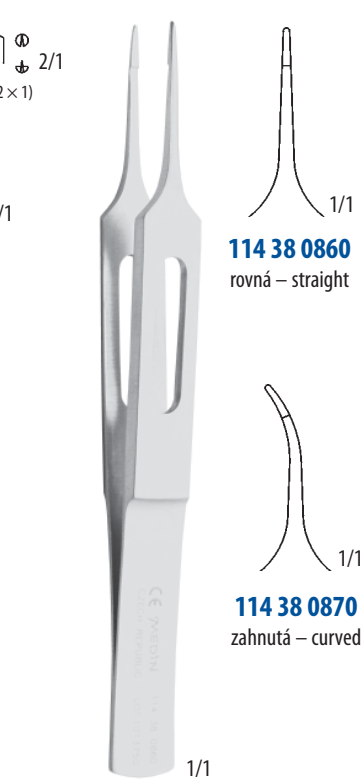

PINZETA NA ROHOVKU
CORNEAL SUTURING FORCEPS
10,0 cm

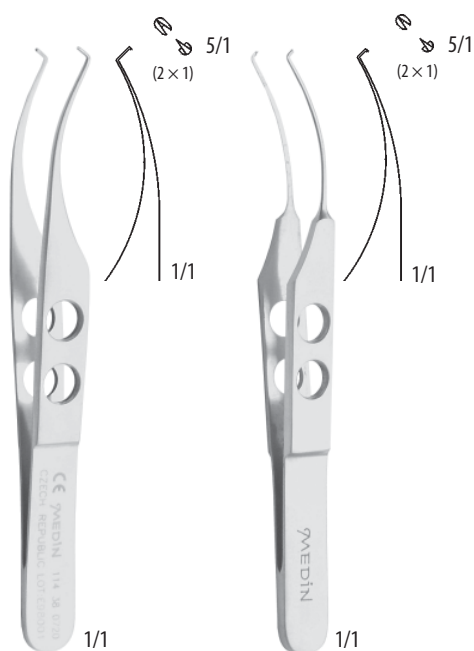

KOLIBRI
114 38 0720
8,0 cm

KOLIBRI
114 38 1300
8,0 cm



PINZETA ŠÍČÍ
SUTURING FORCEPS
114 38 1310
hladká – smooth
8,5 cm



PINZETA ŠÍČÍ
SUTURING FORCEPS
114 38 1320
háčková – hooked
8,5 cm

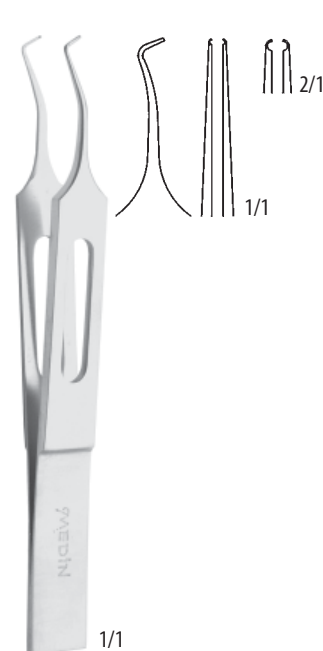

PINZETA ŠÍČÍ
SUTURING FORCEPS
114 38 1330
8,2 cm

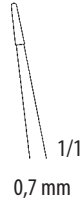
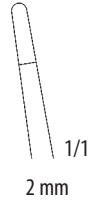
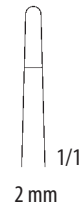
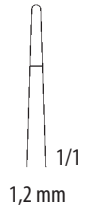
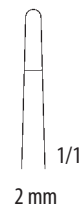
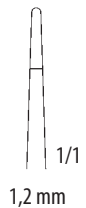

bajonetová – bay-shaped

114 08 1470
22,5 cm

114 08 1480
22,5 cm

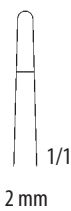
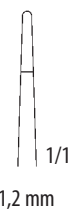
114 08 1490
22,5 cm

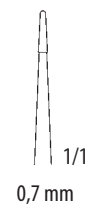
114 08 1500
19,5 cm

114 08 1510
19,5 cm

114 08 1530
19,3 cm

114 08 1540
19,3 cm



1/2



114 08 1560
16,5 cm

114 08 1570
16,5 cm

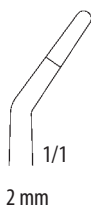
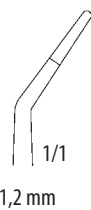
114 08 1580
16,5 cm

114 08 1720
11,5 cm

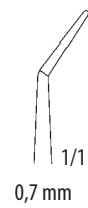
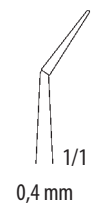
114 08 1730
11,5 cm

1/2

114 08 1690
16,3 cm

114 08 1700
16,3 cm

114 08 1710
16,3 cm

114 08 1750
11,3 cm

114 08 1760
11,3 cm

1/2



MOSQUITO
115 38 0050
5,5 cm



MOSQUITO
115 38 0060
5,3 cm



SVORKA NA OKOHYBNÝ SVAL
CLAMP FOR EYE MUSCLE
115 38 0070
12,5 cm



SVORKA NA CÉVY OČNÍ
CLAMP FOR EYE VESSELS
115 38 0080
8,6 cm



DESMARRES
13,0 cm



GRAEFE
118 38 0050
ostrý – sharp
13,0 cm



GRAEFE
118 38 0060
tupý – blunt
14,0 cm



HÁČEK NA ČOČKOVÉ POUZDRO
CAPSULE HOOK
118 38 0090
14,0 cm



1/1

118 38 0210
13,5 cm

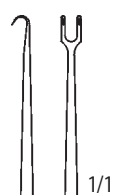

1/1

118 38 0210
2,6 mm

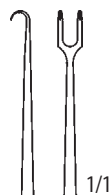

1/1

118 38 0220
3,2 mm

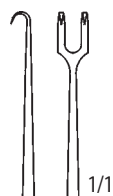

1/1

118 38 0230
4,0 mm



1/1

118 38 0360
14,5 cm

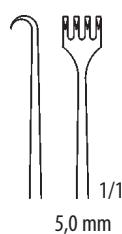

1/1

5,0 mm



1/1

118 38 0370
15,0 cm

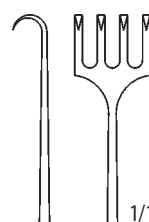

1/1

10,0 mm

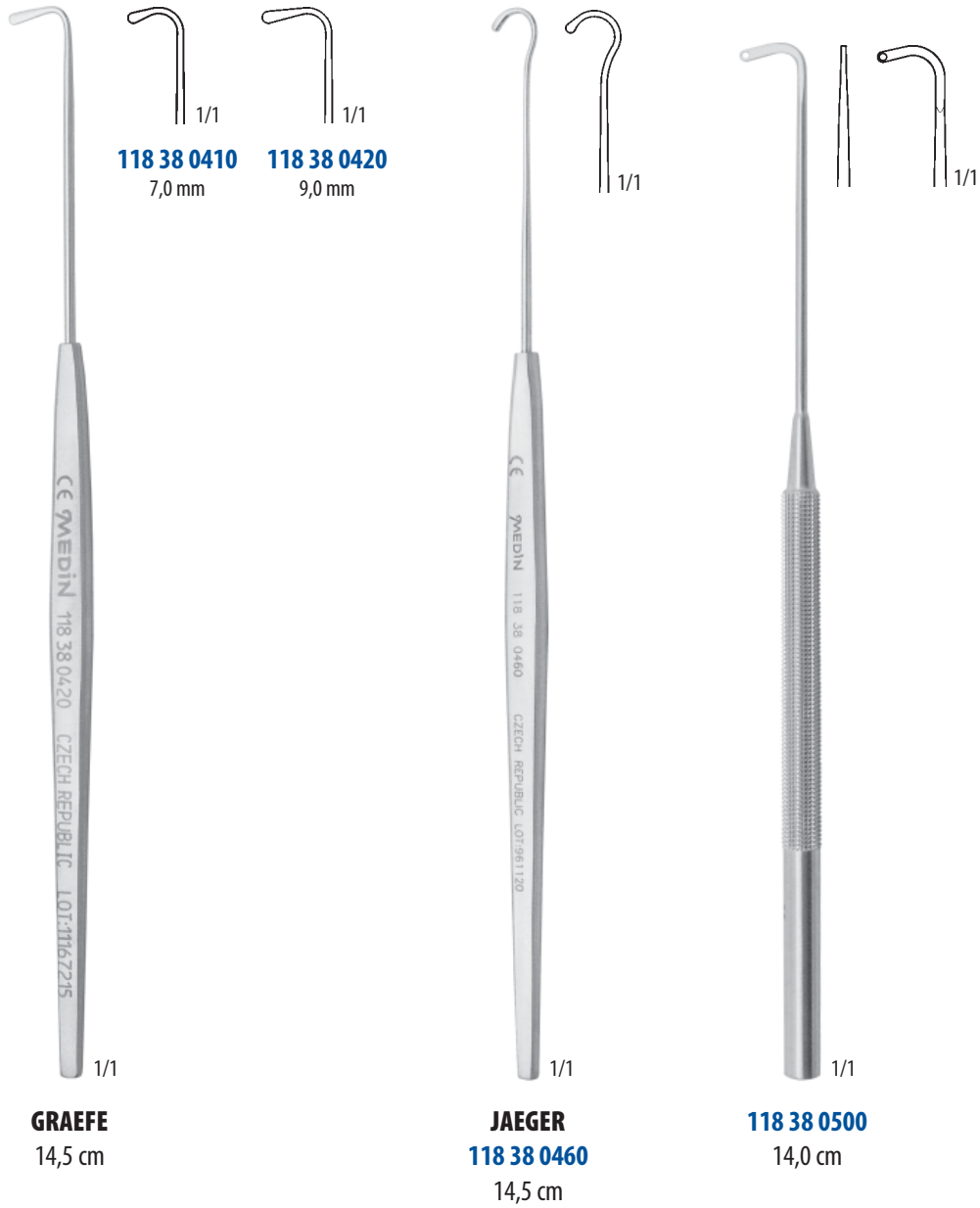



1/1

WEBER
pravý – right
119 38 0050
8,0 cm



1/1

WEBER
levý – left
119 38 0060
8,0 cm



1/1

119 10 0100
kojenecký – infantile
4,3 cm

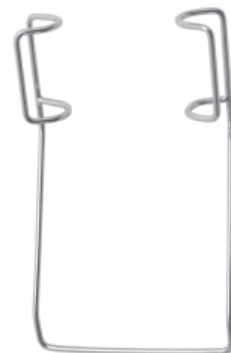

1/1

119 38 0070
mikro – micro
4,6 cm



1/1

MÜLLER
119 38 0400
7,0 cm



1/1

DRŽÁTKO VÍČEK
LID RETRACTOR
119 38 0200
4,9 cm



1/1

DRŽÁTKO VÍČEK
LID RETRACTOR
119 38 0210
4,9 cm

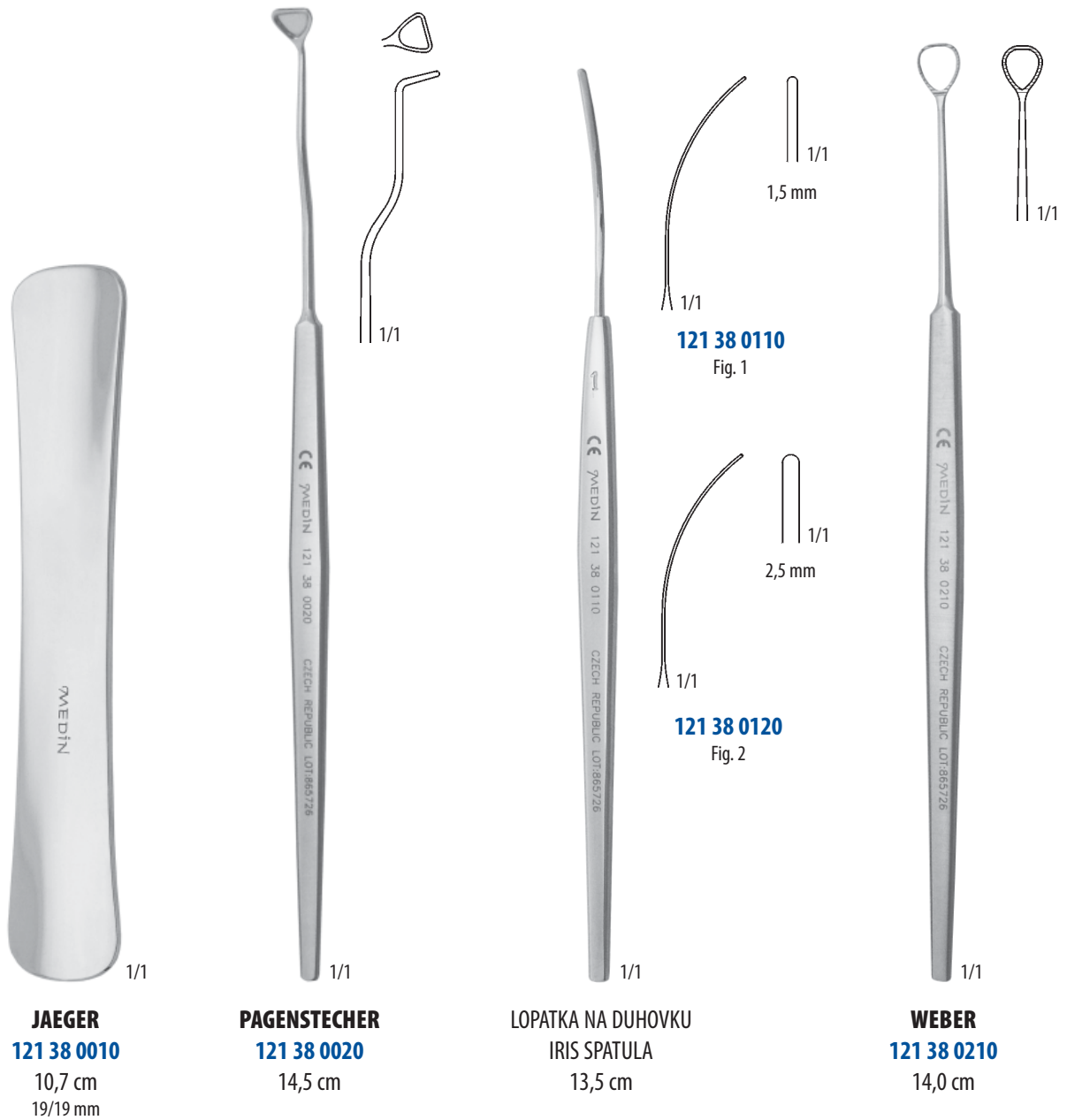



ŠKRABKA NA ROHOVKU
CORNEAL SCARIFIER
124 38 0010
12,5 cm



ŠKRABKA NA ROHOVKU
CORNEAL SCARIFIER
124 38 0070
12,5 cm



ŠKRABKA NA OPERACI SLZNÉHO VAKU
LACHRYMAL SAC RASPATORY
124 38 0160
17,2 cm



1/1

MEYHÖFER
125 38 0040
13,0 cm



125 38 0010
průměr – diameter
1,6 mm



125 38 0020
průměr – diameter
2,2 mm



125 38 0030
průměr – diameter
2,8 mm



125 38 0040
průměr – diameter
3,4 mm



125 38 0050
průměr – diameter
4 mm



1/1

BUNGE
125 38 0170
16,0 cm

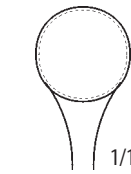

1/1
průměr – diameter
15 mm

průměr – diameter
12,5 mm



1/1



1/1

LANG
125 38 0530
15,0 cm



2/1
průměr – diameter
3,5 mm

průměr – diameter
4,5 mm

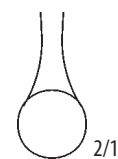

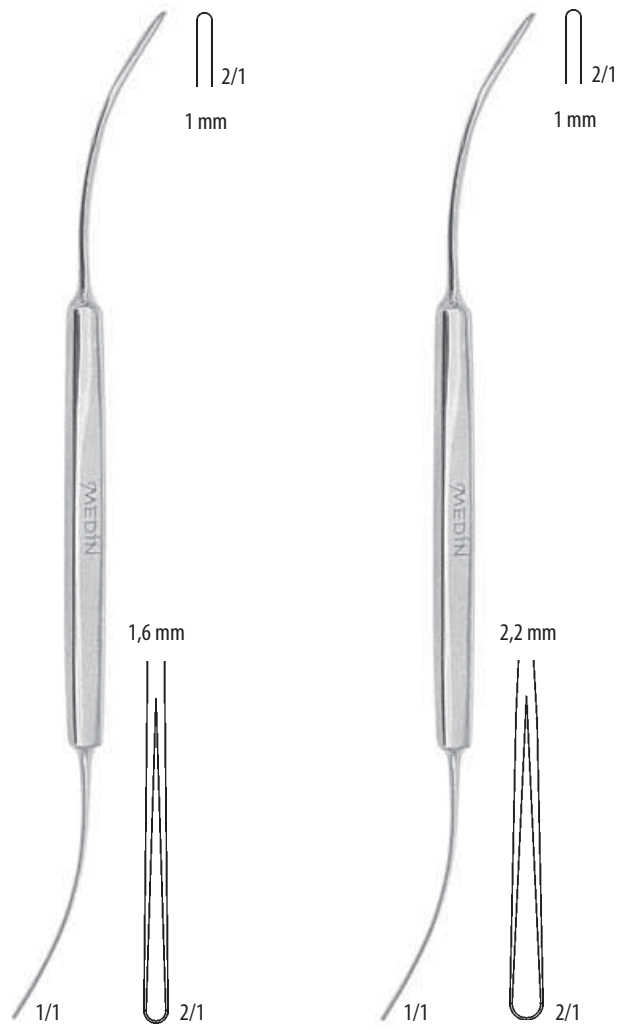

2/1



DAVIEL
125 38 0360
13,3 cm
Fig. 1

DAVIEL
125 38 0370
13,3 cm
Fig. 2



 1/1	 1/1	 1/1
126 38 0010 průměr – diameter 1 mm	126 38 0020 průměr – diameter 1,9 mm	126 38 0030 průměr – diameter 2,9 mm

1/1

 KYRETA NA CHALAZIA
CHALAZION CURETTE

126 38 0020
11,7 cm

RÁM NA VÍČKOVÉ STEHY, JEHLY
FRAME FOR EYE LIGATURE, NEEDLES



FILLATOFF
132 38 0250
 14,4 × 9,0 cm

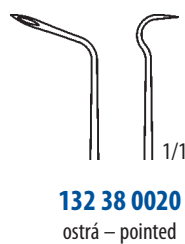

HESSBERG
 JEHLA PODVAZOVACÍ OČNÍ
 EYE SUTURING NEEDLE
132 38 0010
 ostrá – pointed
 16,0 cm

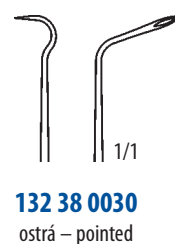

132 38 0020
 ostrá – pointed



132 38 0030
 ostrá – pointed

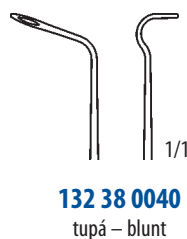

132 38 0040
 tupá – blunt

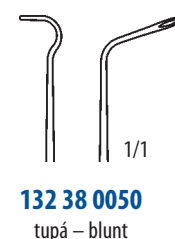

132 38 0050
 tupá – blunt



JEHLA PODVAZOVACÍ OČNÍ
 EYE SUTURING NEEDLE
132 38 0020
 13,5 cm



BOYNTON
132 38 0120
 12,5 cm



JEHELEC NA AMOCE
 EYE NEEDLE HOLDER FOR RETINAS
132 38 0320
 14,0 cm



LANDOLT
132 38 0130
 13,0 cm

JEHELCE OČNÍ
EYE NEEDLE HOLDERS

11,5 cm

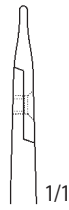

1/1

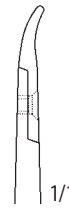
132 38 0210rovný mikro – straight micro
1 mm

1/1

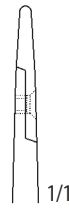
132 38 0220zahnutý mikro – curved micro
1 mm

1/1

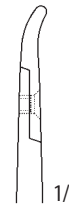
132 38 0230rovný – straight
1,5 mm

1/1

132 38 0240zahnutý – curved
1,5 mm



1/2

CASTROVIEJO
 tvrdokov – TUC
 14,0 cm



1/1

132 91 0213
 tvrdokov – TUC



1/1

132 91 0214
 tvrdokov – TUC



1/2

CASTROVIEJO
 tvrdokov – TUC
 14,0 cm



1/1

132 91 0215
 tvrdokov – TUC



1/1

132 91 0216
 tvrdokov – TUC



1/2

CASTROVIEJO
 tvrdokov – TUC
 18,0 cm



1/1

132 91 0217
 tvrdokov – TUC



1/1

132 91 0218
 tvrdokov – TUC



1/2

CASTROVIEJO
 tvrdokov – TUC
 18,0 cm



1/1

132 91 0219
 tvrdokov – TUC



1/1

132 91 0220
 tvrdokov – TUC



JACOBSON
21,0 cm



132 91 0221
tvrdokov – TUC



132 91 0222
tvrdokov – TUC



DIETHRICH



132 91 0223
tvrdokov – TUC
16,0 cm



132 91 0225
tvrdokov – TUC
20,0 cm



132 91 0224
tvrdokov – TUC
18,0 cm



132 91 0226
tvrdokov – TUC
23,0 cm



132 91 0227
tvrdokov – TUC
26,0 cm

Original 23,0 cm

1/2



POTTS-SMITH
132 91 0230
tvrdokov – TUC
22,0 cm

1/2

CASTROVIEJO
132 91 0229
tvrdokov – TUC
13,0 cm

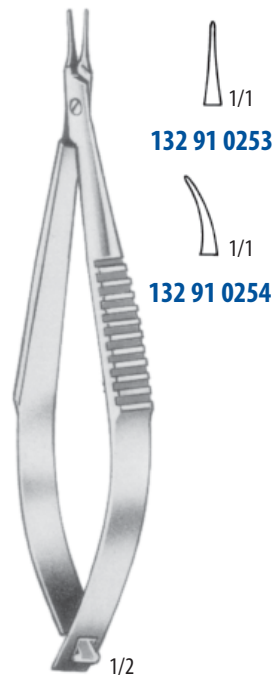

1/2

132 91 0253
132 91 0254

CASTROVIEJO
9,0 cm

132 91 0255
132 91 0256

CASTROVIEJO
s uzávěrem – with ratchet
9,0 cm

MIKRO JEHELCE
MICRO-NEEDLE HOLDERS

1/2

CASTROVIEJO

14,0 cm



1/1

132 91 0257

1/1

132 91 0258

1/1

132 91 0259

1/1

132 91 0260

1/2

CASTROVIEJO

s uzávěrem – with ratchet

14,0 cm



1/1

132 91 0261

1/1

132 91 0262

1/1

132 91 0263

1/1

132 91 0264

1/2

JACOBSON

s uzávěrem – with ratchet



1/1

132 91 0269

18,0 cm



1/1

132 91 0270

21,0 cm

Original 21,0 cm



BOWMANN
133 38 0060
průměr – diameter
0,5 mm
13,0 cm



BOWMANN
133 38 0070
průměr – diameter
0,7 mm
13,0 cm



BOWMANN
133 38 0080
průměr – diameter
0,9 mm
13,0 cm



KURZ
133 38 0160
12,0 cm



SONDA OČNÍ DUTÁ
EYE PROBE
133 38 0200
10,0 cm

	průměr – diameter
133 38 0200	0,5 mm
133 38 0210	0,6 mm
133 38 0220	0,7 mm
133 38 0230	0,8 mm
133 38 0240	0,9 mm



1/1

133 38 0110
7,5 cm
průměr – diameter
0,1 mm



1/1

133 38 0120
7,5 cm
průměr – diameter
0,25 mm



1/1

133 38 0130
7,5 cm
průměr – diameter
0,4 mm

číslo – number	název	item	strana – page
111 38 0010	Měřítka na určení trhlin; 13,0 cm	Rule for cracks determination; 13,0 cm	9
111 38 0030	Měřítka; 10,5 cm	Rule; 10,5 cm	9
111 38 0200	Sklerální depresor; 20 mm; 4,2 cm	Compressor; 20 mm; 4,2 cm	9
112 38 0010	Dieffenbach skalpel oční bříškatý; 1,7 cm	Dieffenbach operating knife fig.1	10
112 38 0020	Dieffenbach skalpel oční bříškatý; 2,0 cm	Dieffenbach operating knife fig.2	10
112 38 0030	Dieffenbach skalpel oční bříškatý; 2,5 cm	Dieffenbach operating knife fig.4	10
112 38 0040	Dieffenbach skalpel oční bříškatý; 3,0 cm	Dieffenbach operating knife fig.5	10
112 38 0110	Dieffenbach skalpel oční hrotnatý; 1,7 cm	Dieffenbach operating knife fig.7	10
112 38 0120	Dieffenbach skalpel oční hrotnatý; 2,0 cm	Dieffenbach operating knife fig.8	10
112 38 0130	Dieffenbach skalpel oční hrotnatý; 2,5 cm	Dieffenbach operating knife fig.9	10
112 38 0140	Dieffenbach skalpel oční hrotnatý; 3,0 cm	Dieffenbach operating knife fig.10	10
112 38 0930	Nůž na keratoplastiku; 13,3 cm	Keratoplasty knife; 13,3 cm	11
112 38 0980	Synechiotom; 13,7 cm	Synechiotome; 13,7 cm	11
112 38 1440	Držátko úlomku žiletek, 9,0 cm	Blade fragment holder; 9,0 cm	11
112 38 2200	Nástroj na cizí tělesa v rohovce; 10,0 cm	Double foreign body instrument; 10,0 cm	10
113 38 0010	Nůžky oční rovné hrotnaté; 10,0 cm	Eye scissors; 10,0 cm	12
113 38 0020	Nůžky oční rovné hrotnatotupé; 10,0 cm	Eye scissors; 10,0 cm	12
113 38 0030	Nůžky oční rovné tupé; 10,0 cm	Eye scissors; 10,0 cm	12
113 38 0040	Nůžky oční zahnuté hrotnaté; 10,0 cm	Eye scissors; 10,0 cm	12
113 38 0050	Nůžky oční zahnuté hrotnatotupé; 10,0 cm	Eye scissors; 10,0 cm	12
113 38 0060	Nůžky oční zahnuté tupé; 10,0 cm	Eye scissors; 10,0 cm	12
113 38 0071	Nůžky oční rovné hrotnaté; 11,5 cm	Eye scissors; 11,5 cm	12
113 38 0081	Nůžky oční rovné tupé; 11,5 cm	Eye scissors; 11,5 cm	12
113 38 0091	Nůžky oční zahnuté hrotnaté; 11,5 cm	Eye scissors; 11,5 cm	12
113 38 0100	Nůžky oční zahnuté hrotnatotupé; 11,5 cm	Eye scissors; 11,5 cm	12
113 38 0150	Nůžky oční rovné hrotnatotupé; 11,5 cm	Eye scissors; 11,5 cm	12
113 38 0161	Nůžky oční zahnuté tupé; 11,5 cm	Eye scissors; 11,5 cm	12
113 38 0210	Nůžky oční lomené hrotnaté; 10,5 cm	Eye scissors; 10,5 cm	12
113 38 0260	Nůžky oční lomené tupé; 10,5 cm	Eye scissors; 10,5 cm	12
113 38 0311	Nůžky oční stranou zahnuté hrotnaté; 11,5 cm	Eye scissors; 11,5 cm	13
113 38 0550	Nůžky enukleační zahnuté; 13,0 cm	Enucleation scissors; 13,0 cm	13
113 38 0850	Nůžky oční pružinové rovné rohovkové; 13,0 cm	Eye scissors for cornea; 13,0 cm	15
113 38 0860	Nůžky oční pružinové zahnuté rohovkové; 13,0 cm	Eye scissors bent for cornea; 13,0 cm	15
113 38 1020	Nůžky oční pružinové zahnuté rohovkové; 9,0 cm	Eye scissors bent for cornea; 9,0 cm	17
113 38 1030	Nůžky oční pružinové lomené rohovkové; 9,0 cm	Eye scissors for cornea; 9,0 cm	17
113 91 0379	Stevens nůžky oční hrotnaté rovné; 10,5 cm	Stevens tenotomy scissors; 10,5 cm	14
113 91 0380	Stevens nůžky oční hrotnaté rovné; 11,5 cm	Stevens tenotomy scissors; 11,5 cm	14
113 91 0381	Stevens nůžky oční hrotnaté zahnuté; 10,5 cm	Stevens tenotomy scissors; 10,5 cm	14
113 91 0382	Stevens nůžky oční hrotnaté zahnuté; 11,5 cm	Stevens tenotomy scissors; 11,5 cm	14
113 91 0383	Stevens nůžky oční tupé rovné; 10,5 cm	Stevens tenotomy scissors; 10,5 cm	14
113 91 0384	Stevens nůžky oční tupé rovné; 11,5 cm	Stevens tenotomy scissors; 11,5 cm	14
113 91 0385	Stevens nůžky oční tupé zahnuté; 10,5 cm	Stevens tenotomy scissors; 10,5 cm	14
113 91 0386	Stevens nůžky oční tupé zahnuté; 11,5 cm	Stevens tenotomy scissors; 11,5 cm	14
113 91 0387	Nůžky oční hrotnaté rovné; 10,0 cm	Eye scissors; 10,0 cm	14
113 91 0388	Nůžky oční hrotnaté zahnuté; 10,0 cm	Eye scissors; 10,0 cm	14
113 91 0389	Nůžky oční tupé rovné; 10,0 cm	Eye scissors; 10,0 cm	14
113 91 0390	Nůžky oční tupé zahnuté; 10,0 cm	Eye scissors; 10,0 cm	14
113 91 0393	Nůžky oční rovné; 9,5 cm	Eye scissors; 9,5 cm	14
113 91 0394	Nůžky oční rovné; 9,5 cm	Eye scissors; 9,5 cm	14
113 91 0395	Nůžky oční rovné; 9,5 cm	Eye scissors; 9,5 cm	14
113 91 0396	Nůžky oční zahnuté; 9,5 cm	Eye scissors; 9,5 cm	14
113 91 0490	Noyes nůžky na duhovku hrotnaté rovné; 12,0 cm	Noyes iris scissors; 12,0 cm	15
113 91 0492	Noyes nůžky na duhovku hrotnatotupé rovné; 12,0 cm	Noyes iris scissors; 12,0 cm	15
113 91 0494	Noyes nůžky na duhovku tupé rovné; 12,0 cm	Noyes iris scissors; 12,0 cm	15
113 91 0499	Barraquer nůžky na duhovku; 5,5 cm; 5 mm	Barraquer eye scissors; 5,5 cm; 5 mm	15
113 91 0500	Barraquer nůžky na duhovku; 5,5 cm; 7 mm	Barraquer eye scissors; 5,5 cm; 7 mm	15
113 91 0501	Barraquer nůžky na duhovku; 5,5 cm; 10 mm	Barraquer eye scissors; 5,5 cm; 10 mm	15
113 91 0502	Castroviejo nůžky na duhovku ostré rovné; 9,0 cm	Castroviejo iris scissors; 9,0 cm	16
113 91 0503	Castroviejo nůžky na duhovku tupé rovné; 9,0 cm	Castroviejo iris scissors; 9,0 cm	16
113 91 0505	Castroviejo nůžky na duhovku tupé lomené; 9,0 cm	Castroviejo iris scissors; 9,0 cm	16
113 91 0507	Castroviejo nůžky na duhovku hrotnaté; 10,0 cm	Castroviejo iris scissors; 10,0 cm	15
113 91 0508	Castroviejo nůžky na duhovku tupé; 10,0 cm	Castroviejo iris scissors; 10,0 cm	15
113 91 0517	Westcott nůžky na rohovku hrotnaté; 11,0 cm	Westcott tenotomy scissors; 11,0 cm	16

číslo – number	název	item	strana – page
113 91 0518	Westcott nůžky na rohovku tupé; 11,0 cm	Westcott tenotomy scissors; 11,0 cm	16
113 91 0521	Castroviejo nůžky oční jemné levé; 11,0 cm	Castroviejo delicate eye scissors; 11,0 cm	16
113 91 0522	Castroviejo nůžky oční jemné pravé; 11,0 cm	Castroviejo delicate eye scissors; 11,0 cm	16
114 08 1470	Pinzeta bipolární bajonetová; 1,2 mm; 25,5 cm	Bipolar forceps bay-shaped; 1,2 mm; 25,5 cm	25
114 08 1480	Pinzeta bipolární bajonetová; 0,7 mm; 25,5 cm	Bipolar forceps bay-shaped; 0,7 mm; 25,5 cm	25
114 08 1490	Pinzeta bipolární bajonetová; 2,0 mm; 25,5 cm	Bipolar forceps bay-shaped; 2,0 mm; 25,5 cm	25
114 08 1500	Pinzeta bipolární rovná; 2,0 mm; 19,5 cm	Bipolar forceps straight; 2,0 mm; 19,5 cm	25
114 08 1510	Pinzeta bipolární rovná; 1,2 mm; 19,5 cm	Bipolar forceps straight; 1,2 mm; 19,5 cm	25
114 08 1530	Pinzeta bipolární zahnutá; 2,0 mm; 19,3 cm	Bipolar forceps curved; 2,0 mm; 19,3 cm	25
114 08 1540	Pinzeta bipolární zahnutá; 1,2 mm; 19,3 cm	Bipolar forceps curved; 1,2 mm; 19,3 cm	25
114 08 1560	Pinzeta bipolární rovná; 2,0 mm; 16,5 cm	Bipolar forceps straight; 2,0 mm; 16,5 cm	25
114 08 1570	Pinzeta bipolární rovná; 1,2 mm; 16,5 cm	Bipolar forceps straight; 1,2 mm; 16,5 cm	25
114 08 1580	Pinzeta bipolární rovná; 0,7 mm; 16,5 cm	Bipolar forceps straight; 0,7 mm; 16,5 cm	25
114 08 1690	Pinzeta bipolární zahnutá; 2,0 mm; 16,3 cm	Bipolar forceps curved; 2,0 mm; 16,3 cm	25
114 08 1700	Pinzeta bipolární zahnutá; 1,2 mm; 16,3 cm	Bipolar forceps curved; 1,2 mm; 16,3 cm	25
114 08 1710	Pinzeta bipolární zahnutá; 0,7 mm; 16,3 cm	Bipolar forceps curved; 0,7 mm; 16,3 cm	25
114 08 1720	Pinzeta bipolární rovná; 0,7 mm; 11,5 cm	Bipolar forceps straight; 0,7 mm; 11,5 cm	25
114 08 1730	Pinzeta bipolární rovná; 0,4 mm; 11,5 cm	Bipolar forceps straight; 0,4 mm; 11,5 cm	25
114 08 1750	Pinzeta bipolární zahnutá; 0,7 mm; 11,3 cm	Bipolar forceps curved; 0,7 mm; 11,3 cm	25
114 08 1760	Pinzeta bipolární zahnutá; 0,4 mm; 11,3 cm	Bipolar forceps curved; 0,4 mm; 11,3 cm	25
114 38 0010	Graefe pinzeta oční rovná; 10,5 cm	Graefe eye forceps; 10,5 cm	18
114 38 0020	Graefe pinzeta oční rovná jemná; 10,5 cm	Graefe eye forceps; 10,5 cm	18
114 38 0030	Graefe pinzeta oční rovná nemagnetická; 10,5 cm	Graefe eye forceps non magnetic; 10,5 cm	18
114 38 0040	Graefe pinzeta oční rovná nemagnetická jemná; 10,5 cm	Graefe eye forceps non magnetic; 10,5 cm	18
114 38 0100	Graefe pinzeta oční zahnutá jemná; 10,5 cm	Graefe eye forceps; 10,5 cm	18
114 38 0110	Graefe pinzeta oční silně zahnutá; 10,0 cm	Graefe eye forceps; 10,0 cm	18
114 38 0120	Graefe pinzeta oční silně zahnutá nemagnetická; 10,0 cm	Graefe eye forceps non magnetic; 10,0 cm	18
114 38 0150	Graefe pinzeta oční rovná; 1×2 zuby; 10,5 cm	Graefe eye forceps; 1×2 teeth; 10,5 cm	18
114 38 0160	Graefe pinzeta oční rovná jemná; 1×2 zuby; 10,5 cm	Graefe eye forceps; 1×2 teeth; 10,5 cm	18
114 38 0170	Graefe pinzeta oční rovná nemagnetická; 1×2 zuby; 10,5 cm	Graefe eye forceps non magnetic; 1×2 teeth; 10,5 cm	18
114 38 0200	Graefe pinzeta oční zahnutá; 1×2 zuby; 10,5 cm	Graefe eye forceps; 1×2 teeth; 10,5 cm	18
114 38 0210	Graefe pinzeta oční silně zah. nemagnet.; 1×2 zuby; 10,0 cm	Graefe eye forceps non magnetic; 1×2 teeth; 10,0 cm	18
114 38 0230	Koutný pinzeta na duhovku zahnutá; 10,0 cm	Koutný iris forceps; 10,0 cm	20
114 38 0250	Pinzeta na duhovku anatomická; 4,8 cm	Iris forceps; 4,8 cm	20
114 38 0270	Pinzeta na duhovku chirurgická zahnutá; 4,8 cm	Iris forceps; 4,8 cm	20
114 38 0290	Landolt pinzeta na duhovku; 6,5 cm	Landolt iris forceps; 6,5 cm	20
114 38 0300	Pinzeta na duhovku šíci; 8,5 cm	Iris forceps; 8,5 cm	20
114 38 0350	Graefe pinzeta fixační; 11,0 cm	Graefe fixation forceps; 11,0 cm	19
114 38 0360	Graefe pinzeta fixační s uzávěrem s perem; 11,0 cm	Graefe fixation forceps; 11,0 cm	19
114 38 0370	Elschnig pinzeta fixační; 10,5 cm	Elschnig fixation forceps; 10,5 cm	19
114 38 0450	Pinzeta na šití rohovkového terče; 4,0 mm; 11,0 cm	Forceps for cornea suturing; 4,0 mm; 11,0 cm	22
114 38 0460	Pinzeta na šití rohovkového terče; 4,5 mm; 11,0 cm	Forceps for cornea suturing; 4,5 mm; 11,0 cm	22
114 38 0470	Pinzeta na šití rohovkového terče; 5,0 mm; 11,0 cm	Forceps for cornea suturing; 5,0 mm; 11,0 cm	22
114 38 0480	Pinzeta na šití rohovkového terče; 5,5 mm; 11,0 cm	Forceps for cornea suturing; 5,5 mm; 11,0 cm	22
114 38 0490	Pinzeta na šití rohovkového terče; 6,0 mm; 11,0 cm	Forceps for cornea suturing; 6,0 mm; 11,0 cm	22
114 38 0500	Pinzeta na šití rohovkového terče; 7,0 mm; 11,0 cm	Forceps for cornea suturing; 7,0 mm; 11,0 cm	22
114 38 0510	Pinzeta na šití rohovkového terče; 8,0 mm; 11,0 cm	Forceps for cornea suturing; 8,0 mm; 11,0 cm	22
114 38 0590	Kuhnt pinzeta na čočkové pouzdro; 10,2 cm	Kuhnt capsule forceps; 10,2 cm	20
114 38 0600	Elschnig pinzeta na čočkové pouzdro fig.1; 10,7 cm	Elschnig capsule forceps fig.1; 10,7 cm	20
114 38 0610	Elschnig pinzeta na čočkové pouzdro fig.2; 10,7 cm	Elschnig capsule forceps fig.2; 10,7 cm	20
114 38 0620	Arruga pinzeta na čočkové pouzdro; 10,8 cm	Arruga capsule forceps; 10,8 cm	21
114 38 0630	Kalt pinzeta na čočkové pouzdro; 10,2 cm	Kalt capsule forceps; 10,2 cm	21
114 38 0640	Bonefone pinzeta na čočkové pouzdro; 10,7 cm	Bonefone capsule forceps; 10,7 cm	21
114 38 0650	Verhoff pinzeta na čočkové pouzdro; 10,6 cm	Verhoff capsule forceps; 10,6 cm	21
114 38 0720	Kolibri pinzeta na duhovku šíci; 8,0 cm	Kolibri pinzeta na duhovku šíci; 8,0 cm	24
114 38 0750	Pinzeta enukleační; 4×5 zubů; 14,0 cm	Enucleation forceps; 4×5 teeth; 14,0 cm	19
114 38 0810	Pinzeta na operaci šilhání pravá; 9,5 cm	Strabismus forceps with lock right; 9,5 cm	22
114 38 0820	Pinzeta na operaci šilhání levá; 9,5 cm	Strabismus forceps with lock left; 9,5 cm	22
114 38 0830	Blascovics pinzeta na operaci šilhání pravá; 9,5 cm	Blascovics strabismus forceps with lock right; 9,5 cm	22
114 38 0840	Blascovics pinzeta na operaci šilhání levá; 9,5 cm	Blascovics strabismus forceps with lock left; 9,5 cm	22
114 38 0850	Castroviejo pinzeta na rohovku; 10,0 cm	Castroviejo corneal forceps; 10,0 cm	24
114 38 0860	Pinzeta na rohovku šíci rovná; 10,0 cm	Corneal suturing forceps; 10,0 cm	24
114 38 0870	Pinzeta na rohovku zahnutá; 10,0 cm	Corneal suturing forceps; 10,0 cm	24
114 38 0910	Desmarres pinzeta na chalazia vel. 1; 8,8 cm	Desmarres chalazion forceps fig.1; 8,8 cm	23
114 38 0920	Desmarres pinzeta na chalazia vel. 2; 9,2 cm	Desmarres chalazion forceps fig.2; 9,2 cm	23
114 38 0930	Desmarres pinzeta na chalazia vel. 3; 9,5 cm	Desmarres chalazion forceps fig.3; 9,5 cm	23
114 38 0940	Desmarres pinzeta na chalazia vel. 4; 9,8 cm	Desmarres chalazion forceps fig.4; 9,8 cm	23
114 38 0950	Desmarres pinzeta na chalazia vel. 5; 10,0 cm	Desmarres chalazion forceps fig.5; 10,0 cm	23
114 38 0960	Lambert pinzeta na chalazia kulatá; 9,0 cm	Lambert chalazion forceps rounded; 9,0 cm	23
114 38 1110	Beer pinzeta na řasy; 3,0 mm; 8,5 cm	Beer cilia forceps; 3,0 mm; 8,5 cm	23

číslo – number	název	item	strana – page
114 38 1120	Beer pinzeta na řasy; 4,5 mm; 8,5 cm	Beer cilia forceps; 4,5 mm; 8,5 cm	23
114 38 1140	Pinzeta na silikonové plomby; 13,0 cm	Silicon seal forceps; 13,0 cm	22
114 38 1170	Pinzeta na řasy zkosená; 8,7 cm	Cilia forceps; 8,7 cm	23
114 38 1230	Pinzeta na keratoplastiku vidlič. lomená; 8,5 cm	Keratoplastic forceps; 8,5 cm	24
114 38 1260	Kalt pinzeta na čočkové pouzdro mikro; 9,5 cm	Kalt capsule micro forceps; 9,5 cm	24
114 38 1300	Kolibří pinzeta na duhovku mikro; 8,0 cm	Kolibri iris micro forceps; 8,0 cm	24
114 38 1310	Pinzeta šicí rovná hladká; 8,5 cm	Suturing forceps; 8,5 cm	24
114 38 1320	Pinzeta šicí rovná háčková; 8,5 cm	Suturing forceps; 8,5 cm	24
114 38 1330	Pinzeta šicí prohnutá háčková; 8,2 cm	Suturing forceps; 8,2 cm	24
114 38 1340	Pinzeta stehová typ 1; 7,8 cm	Suturing forceps fig. 1; 7,8 cm	23
114 38 1350	Pinzeta stehová typ 2; 8,2 cm	Suturing forceps fig. 2; 8,2 cm	23
114 91 0366	Graefe pinzeta oční rovná; 10,0 cm	Graefe eye forceps; 10,0 cm	18
114 91 0368	Graefe pinzeta oční mírně zahnutá; 10,0 cm	Graefe eye forceps; 10,0 cm	18
114 91 0372	Graefe pinzeta oční rovná; 1×2 zuby; 10,0 cm	Graefe eye forceps; 1×2 teeth; 10,0 cm	18
114 91 0374	Graefe pinzeta oční mírně zahnutá; 1×2 zuby; 10,0 cm	Graefe eye forceps; 1×2 teeth; 10,0 cm	18
115 38 0050	Mosquito svorka na cévy rovná; 5,5 cm	Mosquito clamp for eye vessels; 5,5 cm	26
115 38 0060	Mosquito svorka na oční cévy rovná; 5,3 cm	Mosquito clamp for eye vessels; 5,3 cm	26
115 38 0070	Svorka na okohybný sval; 12,5 cm	Clamp for eye muscle; 12,5 cm	26
115 38 0080	Svorka na cévy oční; 8,6 mm	Clamp for eye vessels; 8,6 mm	26
118 38 0010	Desmarres držátko víček; 10,0 mm; 13,0 cm	Desmarres delicate hook; 10,0 mm; 13,0 cm	27
118 38 0020	Desmarres držátko víček; 12,0 mm; 13,0 cm	Desmarres delicate hook; 12,0 mm; 13,0 cm	27
118 38 0030	Desmarres držátko víček; 14,0 mm; 13,0 cm	Desmarres delicate hook; 14,0 mm; 13,0 cm	27
118 38 0050	Graefe háček na duhovku ostrý; 13,0 cm	Graefe iris hook sharp; 13,0 cm	27
118 38 0060	Graefe háček na duhovku tupý; 14,0 cm	Graefe iris hook blunt; 14,0 cm	27
118 38 0090	Háček na čočkové pouzdro tupý; 14,0 cm	Capsule hook blunt; 14,0 cm	27
118 38 0210	Háček oční dvouzubý ostrý; 2,6 mm; 13,5 cm	Eye hook 2 prongs sharp	28
118 38 0220	Háček oční dvouzubý ostrý; 3,2 mm; 13,5 cm	Eye hook 2 prongs sharp	28
118 38 0230	Háček oční dvouzubý ostrý; 4,0 mm; 13,5 cm	Eye hook 2 prongs sharp	28
118 38 0360	Háček oční čtyřzubý ostrý; 5,0 mm; 14,5 cm	Eye hook 4 prongs sharp	28
118 38 0370	Háček oční čtyřzubý ostrý; 10,0 mm; 15,0 cm	Eye hook 4 prongs sharp	28
118 38 0410	Graefe háček na operaci šilhání; 7,0 mm; 14,5 cm	Graefe strabismus hook; 7,0 mm; 14,5 cm	29
118 38 0420	Graefe háček na operaci šilhání; 9,0 mm; 14,5 cm	Graefe strabismus hook; 9,0 mm; 14,5 cm	29
118 38 0460	Jaeger háček na operaci šilhání; 14,5 cm	Jaeger strabismus hook; 14,5 cm	29
118 38 0500	Háček na oční sval; 14,0 cm	Hook for eye muscle; 14,0 cm	29
119 10 0100	Rozvěrač víček kojenecký; 4,3 cm	Lid retractor for infants; 4,3 cm	30
119 38 0050	Weber rozvěrač víček pravý nemagnetický; 8,0 cm	Weber lid retractor; 8,0 cm	30
119 38 0060	Weber rozvěrač víček levý nemagnetický; 8,0 cm	Weber lid retractor; 8,0 cm	30
119 38 0070	Rozvěrač víček mikro; 4,6 cm	Lid retractor micro; 4,6 cm	30
119 38 0200	Držátko očních víček; 12 mm; 4,9 cm	Lid retractor; 12 mm; 4,9 cm	30
119 38 0210	Držátko očních víček; 8 mm; 4,9 cm	Lid retractor; 8 mm; 4,9 cm	30
119 38 0400	Müller rozvěrač ran oční; 7,0 cm	Müller eye retractor; 7,0 cm	30
121 38 0010	Jaeger destička na víčkové operace; 19×19 mm; 10,7 cm	Jaeger eye lid plate; 19×19 mm; 10,7 cm	31
121 38 0020	Pagenstecher lopatka na hmotu čočky; 14,5 cm	Pagenstecher lens spatula; 14,5 cm	31
121 38 0110	Lopatka na duhovku zahnutá fig.1; 13,5 cm	Iris spatula curved fig.1; 13,5 cm	31
121 38 0120	Lopatka na duhovku zahnutá fig.2; 13,5 cm	Iris spatula curved fig.2; 13,5 cm	31
121 38 0210	Weber klička oční; 14,0 cm	Weber wire loop; 14,0 cm	31
124 38 0010	Škrabka na rohovku rovná; 12,5 cm	Corneal scarifier; 12,5 cm	32
124 38 0070	Škrabka na rohovku lomená; 12,5 cm	Corneal scarifier; 12,5 cm	32
124 38 0160	Škrabka na operaci slzného vaku; 17,2 cm	Lachrymal sac raspatory; 17,2 cm	32
125 38 0010	Meyhöfer lžička na chalazia kulatá; 1,6 mm; 13,0 cm	Meyhöfer chalazion spoon; 1,6 mm; 13,0 cm	33
125 38 0020	Meyhöfer lžička na chalazia kulatá; 2,2 mm; 13,0 cm	Meyhöfer chalazion spoon; 2,2 mm; 13,0 cm	33
125 38 0030	Meyhöfer lžička na chalazia kulatá; 2,8 mm; 13,0 cm	Meyhöfer chalazion spoon; 2,8 mm; 13,0 cm	33
125 38 0040	Meyhöfer lžička na chalazia kulatá; 3,4 mm; 13,0 cm	Meyhöfer chalazion spoon; 3,4 mm; 13,0 cm	33
125 38 0050	Meyhöfer lžička na chalazia kulatá; 4,0 mm; 13,0 cm	Meyhöfer chalazion spoon; 4,0 mm; 13,0 cm	33
125 38 0170	Bunge lžička exenterační; 15×12,5 mm; 16,0 cm	Bunge exenteration spoon; 15×12,5 mm; 16,0 cm	33
125 38 0360	Daviel lžička oční s lopatkou fig.1; 1×1,6 mm; 13,3 cm	Daviel eye spoon with spatula fig.1; 1×1,6 mm; 13,3 cm	34
125 38 0370	Daviel lžička oční s lopatkou fig.2; 1×2,2 mm; 13,3 cm	Daviel eye spoon with spatula fig.2; 1×2,2 mm; 13,3 cm	34
125 38 0530	Lang lžička oční ostrá; 3,5×4,5 mm; 15,0 cm	Lang eye spoon; 3,5×4,5 mm; 15,0 cm	33
126 38 0010	Kyreta na chalazia; 1 mm; 11,7 cm	Chalazion curette; 1 mm; 11,7 cm	35
126 38 0020	Kyreta na chalazia; 1,9 mm; 11,7 cm	Chalazion curette; 1,9 mm; 11,7 cm	35
126 38 0030	Kyreta na chalazia; 2,9 mm; 11,7 cm	Chalazion curette; 2,9 mm; 11,7 cm	35
132 38 0010	Hessberg jehla oční podvazovací háčková; 16,0 cm	Hessberg needle; 16,0 cm	36
132 38 0020	Jehla oční podvazovací ostrá pravá; 13,5 cm	Eye needle sharp right; 13,5 cm	36
132 38 0030	Jehla oční podvazovací ostrá levá; 13,5 cm	Eye needle sharp left 13,5 cm	36
132 38 0040	Jehla oční podvazovací tupá pravá; 13,5 cm	Eye needle blunt right; 13,5 cm	36
132 38 0050	Jehla oční podvazovací tupá levá; 13,5 cm	Eye needle blunt left 13,5 cm	36
132 38 0120	Boynton jehelec oční; 12,5 cm	Boynton eye needle holder; 12,5 cm	37
132 38 0130	Landolt jehelec oční; 13,0 cm	Landolt eye needle holder; 12,5 cm	37
132 38 0210	Jehelec oční pružinový mikro rovný; 11,5 cm	Micro-needle holder; 11,5 cm	38
132 38 0220	Jehelec oční pružinový mikro zahnutý; 11,5 cm	Micro-needle holder; 11,5 cm	38

číslo – number	název	item	strana – page
132 38 0230	Jehelec oční pružinový rovný 11,5 cm	Needle holder; 11,5 cm	38
132 38 0240	Jehelec oční pružinový zahnutý; 11,5 cm	Needle holder; 11,5 cm	38
132 38 0250	Fillatoff rámeček na víčkové stehy; 14,4×9,0 mm	Fillatoff frame for eye ligature; 14,4×9,0 mm	36
132 38 0320	Jehelec na amoce; 14,0 cm	Eye needle holder for retinas; 14,0 cm	37
132 91 0213	Castroviejo jehelec rovný hladký tvrdokov; 14,0 cm	Castroviejo needle holder TUC; 14,0 cm	39
132 91 0214	Castroviejo jehelec zahnutý hladký tvrdokov; 14,0 cm	Castroviejo needle holder TUC; 14,0 cm	39
132 91 0215	Castroviejo jehelec rovný vroubkovaný tvrdokov; 14,0 cm	Castroviejo needle holder TUC; 14,0 cm	39
132 91 0216	Castroviejo jehelec zahnutý vroubkovaný tvrdokov; 14,0 cm	Castroviejo needle holder TUC; 14,0 cm	39
132 91 0217	Castroviejo jehelec rovný hladký tvrdokov; 18,0 cm	Castroviejo micro-needle holder TUC; 18,0 cm	39
132 91 0218	Castroviejo jehelec zahnutý hladký tvrdokov; 18,0 cm	Castroviejo micro-needle holder TUC; 18,0 cm	39
132 91 0219	Castroviejo jehelec rovný vroubkovaný tvrdokov; 18,0 cm	Castroviejo micro-needle holder TUC; 18,0 cm	39
132 91 0220	Castroviejo jehelec zahnutý vroubkovaný tvrdokov; 18,0 cm	Castroviejo micro-needle holder TUC; 18,0 cm	39
132 91 0221	Jacobson jehelec mikro hladký tvrdokov; 21,0 cm	Jacobson micro-needle holder TUC; 21,0 cm	40
132 91 0222	Jacobson jehelec mikro vroubkovaný tvrdokov; 21,0 cm	Jacobson micro-needle holder TUC; 21,0 cm	40
132 91 0223	Diethrich jehelec mikro tvrdokov; 16,0 cm	Diethrich micro-needle holder TUC; 16,0 cm	40
132 91 0224	Diethrich jehelec mikro tvrdokov; 18,0 cm	Diethrich micro-needle holder TUC; 18,0 cm	40
132 91 0225	Diethrich jehelec mikro tvrdokov; 20,0 cm	Diethrich micro-needle holder TUC; 20,0 cm	40
132 91 0226	Diethrich jehelec mikro tvrdokov; 23,0 cm	Diethrich micro-needle holder TUC; 23,0 cm	40
132 91 0227	Diethrich jehelec mikro tvrdokov; 26,0 cm	Diethrich micro-needle holder TUC; 26,0 cm	40
132 91 0229	Castroviejo jehelec mikro hladký tvrdokov; 13,0 cm	Castroviejo needle holder TUC; 13,0 cm	40
132 91 0230	Potts-Smith jehelec mikro tvrdokov; 22,0 cm	Potts-Smith micro-needle holder TUC; 22,0 cm	40
132 91 0253	Castroviejo jehelec mikro rovný; 9,0 cm	Castroviejo micro-needle holder; 9,0 cm	41
132 91 0254	Castroviejo jehelec mikro zahnutý; 9,0 cm	Castroviejo micro-needle holder; 9,0 cm	41
132 91 0255	Castroviejo jehelec mikro rovný s uzávěrem; 9,0 cm	Castroviejo micro-needle holder; 9,0 cm	41
132 91 0256	Castroviejo jehelec mikro zahnutý s uzávěrem; 9,0 cm	Castroviejo micro-needle holder; 9,0 cm	41
132 91 0257	Castroviejo jehelec mikro rovný hladký; 14,0 cm	Castroviejo micro-needle holder; 14,0 cm	42
132 91 0258	Castroviejo jehelec mikro zahnutý hladký; 14,0 cm	Castroviejo micro-needle holder; 14,0 cm	42
132 91 0259	Castroviejo jehelec mikro rovný vroubkovaný; 14,0 cm	Castroviejo micro-needle holder; 14,0 cm	42
132 91 0260	Castroviejo jehelec mikro zahnutý vroubkovaný; 14,0 cm	Castroviejo micro-needle holder; 14,0 cm	42
132 91 0261	Castroviejo jehelec rovný hladký s uzávěrem; 14,0 cm	Castroviejo micro-needle holder; 14,0 cm	42
132 91 0262	Castroviejo jehelec zahnutý hladký s uzávěrem; 14,0 cm	Castroviejo micro-needle holder; 14,0 cm	42
132 91 0263	Castroviejo jehelec rovný vroubk. s uzávěrem; 14,0 cm	Castroviejo micro-needle holder; 14,0 cm	42
132 91 0264	Castroviejo jehelec zahnutý vroubk. s uzávěrem; 14,0 cm	Castroviejo micro-needle holder; 14,0 cm	42
132 91 0269	Jacobson jehelec mikro s uzávěrem; 18,0 cm	Jacobson micro-needle holder; 18,0 cm	42
132 91 0270	Jacobson jehelec mikro s uzávěrem; 21,0 cm	Jacobson micro-needle holder; 21,0 cm	42
133 38 0060	Bowmann pátradlo oční nerez; 0,5 mm; 13,0 cm	Bowmann, eye probe; 0,5 mm; 13,0 cm	43
133 38 0070	Bowmann pátradlo oční nerez; 0,7 mm; 13,0 cm	Bowmann, eye probe; 0,7 mm; 13,0 cm	43
133 38 0080	Bowmann pátradlo oční nerez; 0,9 mm; 13,0 cm	Bowmann, eye probe; 0,9 mm; 13,0 cm	43
133 38 0110	Dilatátor slzných bodů; 0,1 mm; 7,5 cm	Eye dilatator; 0,1 mm; 7,5 cm	44
133 38 0120	Dilatátor slzných bodů; 0,25 mm; 7,5 cm	Eye dilatator; 0,25 mm; 7,5 cm	44
133 38 0130	Dilatátor slzných bodů; 0,4 mm; 7,5 cm	Eye dilatator; 0,4 mm; 7,5 cm	44
133 38 0160	Kurz pátradlo oční kojenecké; 12,0 cm	Kurz eye probe for sucklings; 12,0 cm	43
133 38 0200	Sonda oční dutá; 0,5 mm; 10,0 cm	Eye probe; 0,5 mm; 10,0 cm	43
133 38 0210	Sonda oční dutá; 0,6 mm; 10,0 cm	Eye probe; 0,6 mm; 10,0 cm	43
133 38 0220	Sonda oční dutá; 0,7 mm; 10,0 cm	Eye probe; 0,7 mm; 10,0 cm	43
133 38 0230	Sonda oční dutá; 0,8 mm; 10,0 cm	Eye probe; 0,8 mm; 10,0 cm	43
133 38 0240	Sonda oční dutá; 0,9 mm; 10,0 cm	Eye probe; 0,9 mm; 10,0 cm	43

© 2009 MEDIN, a.s.; Všechna práva vyhrazena.

Dokument je určen pro obchodní účely MEDIN, a.s., údaje zde uvedené jsou informativního charakteru.

Žádná část tohoto dokumentu nesmí být reprodukována nebo publikována v jakékoliv formě bez předchozího souhlasu MEDIN, a.s.

Zobrazení produktů odpovídá aktuálnímu stavu v době vydání tohoto dokumentu. Změny technických parametrů z důvodu dalšího vývoje jsou vyhrazeny.

Tiskové a typografické chyby jsou vyhrazeny.

© 2009 MEDIN, a.s.; All rights reserved.

This document should be used for commercial purposes of MEDIN, a.s.; the data mentioned in the document has informative character.

No part of this document can be copied or published in any form without approval of MEDIN, a.s.

The product design may differ from those depicted in these illustrations at the date of issue. Adjustments, made from the reason of further developments of technical parameters, are reserved.

Printing and typographical errors are reserved.

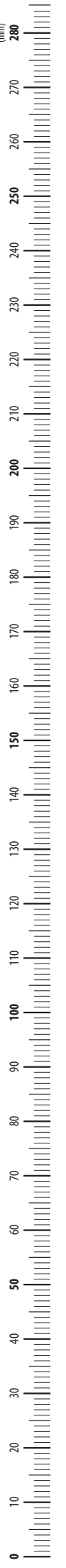

MEDIN, a.s.

Vlachovická 619
Nové Město na Moravě
CZ 592 31
Czech Republic
IČO 43378030
DIČ CZ43378030

CENTRÁLA

tel.: 566 684 111

PRODEJ ČESKÁ REPUBLIKA

tel.: 566 684 327-8
fax: 566 684 384
e-mail: prodej@medin.cz

PRODEJNA PRAHA

Jana Želivského 6
Praha 3
CZ 130 00
tel./fax: 222 592 334
mobil: 606 686 530

PRODEJ SLOVENSKÁ REPUBLIKA

tel.: +420 566 684 332
fax: +420 566 684 385
e-mail: export@medin.cz

EXPORT

phone: +420 566 684 336
fax: +420 566 684 385
e-mail: export@medin.cz

www.medin.cz

NÁSTROJE PRO OČNÍ LÉKAŘSTVÍ INSTRUMENTS FOR OPHTHALMOLOGY

2009

